

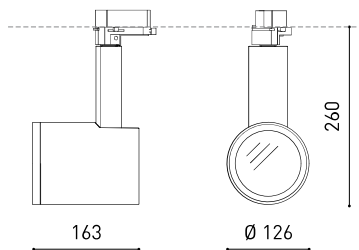

GRÖÖE



ZUBEHÖR



HIGH CHROMATIC LED



ANTI-GLARE HONEYCOMB LOUVER



ANTI-GLARE SCREEN



ELLIPTICAL REFRACTOR



BEAM MIXER DIFFUSER



TRACK 3L OPTIONS

PREISE



PRODUKT

Name	THOR 2 SPOT 17° 3000K NT
Artikelnummer	A2262111NT
Farbe	Schwarz strukturiert
RAL	9005
Kategorie	TRACKLIGHTS

LICHTQUELLE

Typ	LED
Bruttolichtstrom	4750 lm
Farbtemperatur	3000 K - Andere K, Bitte anfragen
Farbstabilität	MacAdam Step 2
Farbwiedergabeindex	CRI > 90
Leistung	36 W
Stromstärke	1050 mA
Lichtausbeute	132 lm/W
Nutzlebensdauer der LED in Betriebsstunden	L90B10 > 55.000h

LEUCHE | PHOTOMETRISCHE DATEN

Leuchtenwirkungsgrad (LOR)	90%
Abstrahlwinkel	17°

LEUCHE | ELEKTRISCHE DATEN

Driver	Inklusiv
Leistungswerte des Systems	39,69 W
Spannung	220V/240V
Frequenz	50/60 Hz
Helligkeitssteuerung	No Dim
Schutzklasse	⚡

ANDERE DATEN

Dichtigkeit	IP20
Wireless control	Bitte anfragen
Schwenkwinkel	90°
Drehwinkel	325°
Schiementyp	Track 3L+N
Gewicht	2015 g
Gewicht inkl. Verpackung	2300 g
Abmessungen der Verpackung	368 x 171 x 184 mm
Stück pro Verpackung	1
Materialien	Aluminium / Glas-Transparent



Von den auf dem Markt erhältlichen Strahlern mit hohem Lichtstrom ist Thor der kompakteste, der mit passiver Wärmeabfuhr funktioniert. Dank seines symmetrischen Gehäusearms und in diesem integrierten Treibers, sowie einem perfekt zentrierten Masseschwerpunkt, lässt sich Thor in jede gewünschte Position ausrichten, ohne die geringsten Neigungskräfte zu generieren, die eine den Strahler tragende Schiene verziehen könnte.

POLAR-KOORDINATEN DIAGRAMM

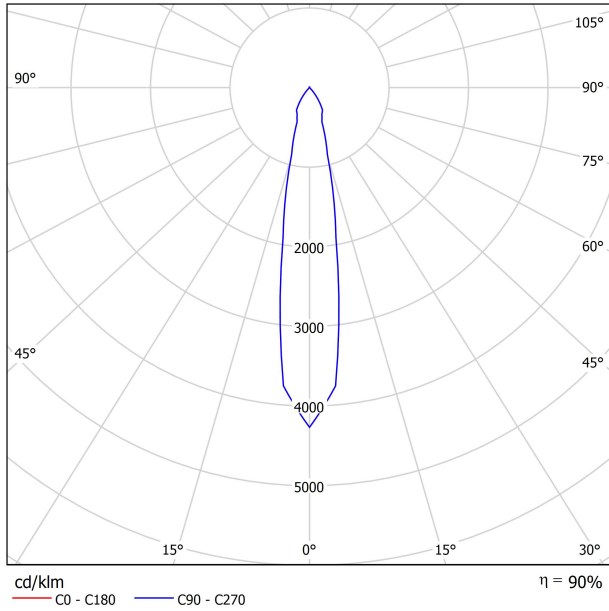

KEGELDIAGRAMM

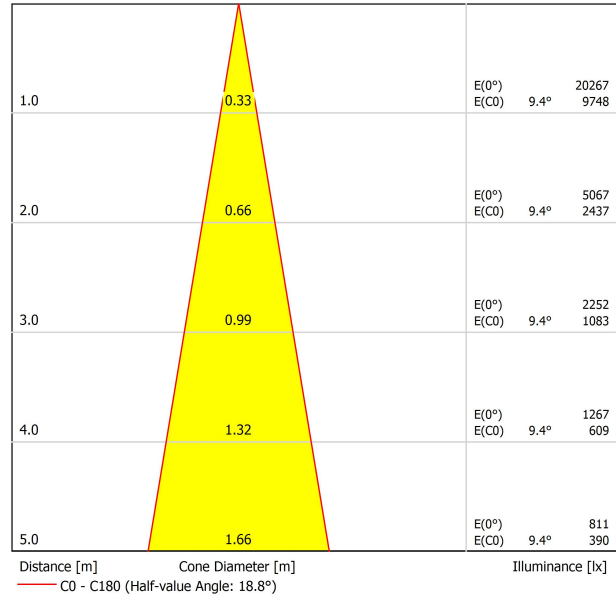

FÜR DIE PRODUKTPRÄSENTATION

Vivid Model Colour Temperature	2700K	3000K	3500K	4000K	Light Pink
📖 Reading			•	•	
🥬 Fruits & Vegetables		•	•		
🍞 Bakery	•				
👤 Retail		•	•		
💄 Cosmetics			•	•	
🥩 Meat					•
🐟 Fish				•	
🐠 Seafood				•	•



Einige der Produkte von Arkoslight können mit einer Spezial-LED für die visuelle Bewerbung von Waren und Produkten zur Verkaufsförderung ausgerüstet werden.

Dabei handelt es sich um eine hochchromatische LED, um Farbtöne hervorzuheben, die positive psychologische Wahrnehmung des beleuchteten Objekts begünstigen.

Diese spezielle LED-Lichtquelle bietet eine ansprechendere und intensivere Farbpalette als eine herkömmliche LED. Dies wird durch die Konfiguration der LED nach einem "speziellen Sättigungsparameter" erreicht, der Farben und Textur der Objekte innerhalb des sichtbaren Spektralbereichs attraktiver erscheinen lässt. Dafür wird die jeweils zweckdienliche Diode und spezifische Phosphorbeschichtung gewählt.



	PRODUCT
Model	Anti-glare Honeycomb Louver
Reference	08020200
Category	Accessories

WIRD NICHT SEPARAT VERKAUFT.



Zubehör in Form eines Wabengitters, um die Blendung und den direkten Einfall der Strahlen in die Augen zu reduzieren.



	PRODUCT
Model	THOR Anti-glare Screen
Reference	08020000NT
Colour	NT ■ Textured black
Category	Accessories

Optionales Schirm-Accessoire für die asymmetrische Ausrichtung des Lichtbündels, um zum einen die Blendung zu reduzieren und zum anderen einen seitlichen Lichteinfall zu erzielen (zum Beispiel für Wandbestrahlung).



	PRODUCT
Model	Elliptical Refractor
Reference	08020400
Category	Accessories

WIRD NICHT SEPARAT VERKAUFT.

Linse, die das Lichtbündel durch die Lichtbrechung in ihrem optischen Glas in eine elliptische Form umwandelt.



	PRODUCT
Model	Beam Mixer Diffuser
Reference	08050300
Category	Accessories

WIRD NICHT SEPARAT VERKAUFT.

Der Strahlenmischdiffusor wird verwendet, um durch parabolische, Fresnel- oder TIR-Linsen-Kollimatoren verursachte Strahlenartefakte ohne wesentliche Ausdehnung zu glätten.

Das einzigartige Mischungskonzeption sorgt für hochwertige Fernfeldglättung und Farbmischung bei hoher on-axis-Helligkeit. Im Vergleich zu herkömmlichen Diffusoren bewahrt er eine höhere Lichtstärkenspitze (CBCP) und ruft bei größeren Winkeln weniger unerwünschte "Lichtfelder" hervor.

TRACK 3L+N SURFACE & SUSPENDED

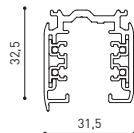

TRACK 3L 1m	A282-01-00- B N
TRACK 3L 2m	A282-02-00- B N
TRACK 3L 3m	A282-03-00- B N



TRACK 3L+N FLUSH MOUNTING*

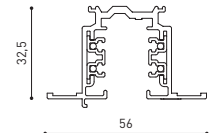

TRACK 3L FLUSH 1m	A282-11-00- B N
TRACK 3L FLUSH 2m	A282-12-00- B N
TRACK 3L FLUSH 3m	A282-13-00- B N



WEIGHT BEAR CAPACITY

Distancia de fijación y capacidad de carga.
Distancia fijación recomendada l- 1000 mm.

Fastening distance and loading capacity.
Recommended fastening distance l- 1000 mm.

Distance de fixation et capacité de charge.
Distance de fixation recommandée l- 1000 mm.

Distanza di installazione e capacità di carico.
Distanza consigliata di fissazione l- 1000 mm.

Befestigungsabstand und Belastbarkeit.
Empfohlener Abstand l- 1000 mm.

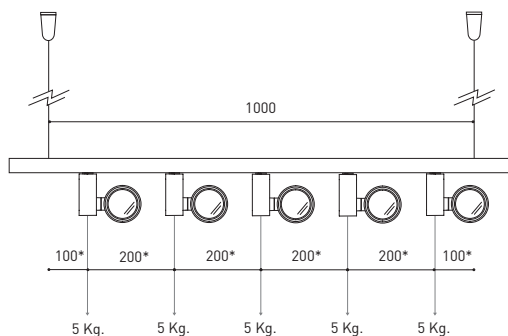

*minimum distance (mm.)

ACCESSORIES

FIT MODEL: ACCESSORIES ONLY IN BLACK FINISH
SIX MODEL: ACCESSORIES NOT AVAILABLE

TRACKLIGHT Surface Adapter

0000-55-43- | W |

0000-55-39- | N |



TRACKLIGHT Recessed Adapter

0000-55-44- | W |

0000-55-40- | N |



COLOUR | B □ RAL 9016 | N ■ RAL 9005 |

SURFACE & SUSPENDED

FLUSH MOUNTING

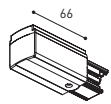

POLARITY GROOVE



TRACK 3L Live-End Connector

A282-00-01- | B | N |

A282-00-02- | B | N |

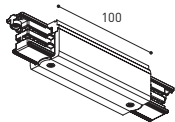

TRACK 3L Central Connector

A282-00-03- | B | N |



TRACK 3L Ceiling Kit

A219-21-06- | B | N |

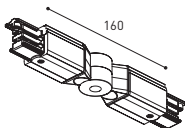

TRACK 3L Universal Angle

A282-00-15- | B | N |

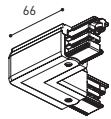

TRACK 3L 90° Angle

A282-00-06- | B | N |

A282-00-07- | B | N |

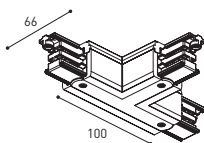

TRACK 3L T Joint

A282-00-16- | B | N |

A282-00-17- | B | N |

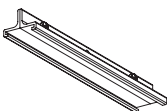

TRACK 3L Mechanical Joint

A219-21-11- | B | N |



TRACK 3L Suspension Kit

A219-21-10- | B | N |

At least 2 units needed

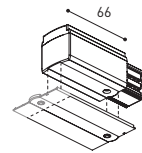

POLARITY GROOVE



TRACK 3L Live-End Connector

A282-00-01- | B | N |

A282-00-02- | B | N |

TRACK 3L FLUSH Cover Plate

A282-10-19- | B | N |

Mandatory for installation

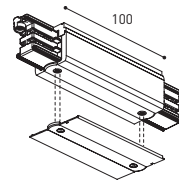

TRACK 3L Central Connector

A282-00-03- | B | N |

TRACK 3L FLUSH Cover Plate

A282-10-19- | B | N |

Mandatory for installation



TRACK 3L FLUSH Ceiling Kit

A219-22-06- | B |

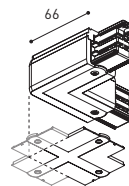

TRACK 3L 90° Angle

A282-00-06- | B | N |

A282-00-07- | B | N |



TRACK 3L FLUSH Corner Cover Plate

A282-10-20- | B | N |

Mandatory for installation

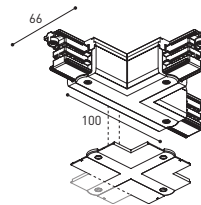

TRACK 3L T Joint

A282-00-16- | B | N |

A282-00-17- | B | N |



TRACK 3L FLUSH Corner Cover Plate

A282-10-20- | B | N |

Mandatory for installation

SURFACE & SUSP. / FLUSH MOUNTING

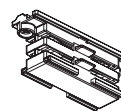

TRACK Contact Joint

A282-00-04- | B | N |



TRACK End

A219-20-02- | B | N |



TRACK Clamp Kit for M6 ROD

A219-21-21- | B |

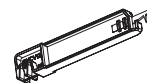

TRACK Bending Tool

A282-00-00

For tracks its length has been modified

COLOUR | B □ RAL 9016 | N ■ RAL 9005 |

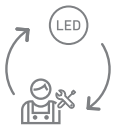

Fuente de luz (LED) reemplazable por un profesional autorizado

Replaceable (LED only) light source by an authorized professional.

Source lumineuse (LED) remplaçable par un professionnel agréé

Sorgente luminosa (LED) sostituibile da parte di un professionista autorizzato

Austauschbare (LED) Lichtquelle durch einen autorisierten Fachmann



Equipo de control reemplazable por un profesional autorizado

Replaceable control gear by an authorized professional

Dispositif de commande remplaçable par un professionnel agréé

Alimentatore sostituibile da parte di un professionista autorizzato

Auswechselbares Betriebsgerät durch autorisierten Fachmann

INSTRUCCIONES PARA EL FINAL DE VIDA Y LA ELIMINACIÓN LOS COMPONENTES
 INSTRUCTIONS ON END-OF-LIFE AND COMPONENT DISPOSAL
 INSTRUCTIONS POUR LA GESTION DES COMPOSANTS EN FIN DE VIE ET LEUR MISE AU REBUT
 ISTRUZIONI PER IL FINE VITA E LO SMALTIMENTO DEI COMPONENTI
 ANWEISUNGEN ZUR ENTSORGUNG DER LEUCHTENKOMPONENTEN



Interrumpir la alimentación del aparato
 Cut the power supply to the luminaire
 Couper l'alimentation du luminaire
 Interrompere l'alimentazione dell'apparecchio
 Stromversorgung der Leuchte unterbrechen



Quitar la(s) fuente(s) de luz para el desecho
 Remove light source(s) for disposal
 Retirer la (les) source(s) lumineuse(s) pour l'élimination
 Rimuovere la/le sorgente/e di luce per lo smaltimento
 Lichtquelle(n) zur Entsorgung entfernen

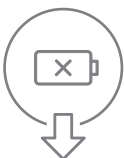

Quitar la batería para el desecho
 Remove the battery for decommissioning
 Retirer la batterie pour sa mise au rebut
 Rimuovere la batteria per la dismissione
 Die Batterie ordnungsgemäß entsorgen



Quitar el equipo de control para el desecho
 Remove control gear for disposal
 Retirer le dispositif de commande pour l'élimination
 Rimuovere l'alimentatore per lo smaltimento
 Betriebsgerät zur Entsorgung ausbauen



Enviar los materiales a un centro de recogida RAEE
 Send the materials to a WEEE collection centre
 Envoyer les matériaux dans une déchetterie DEEE
 Inviare i materiali ad un centro di raccolta RAEE
 Die Materialien in einem WEEE-Zentrum entsorgen

