

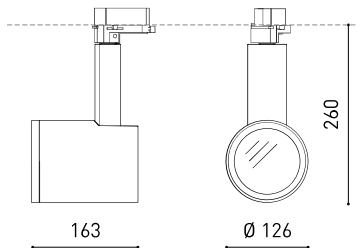

DIMENSIONS

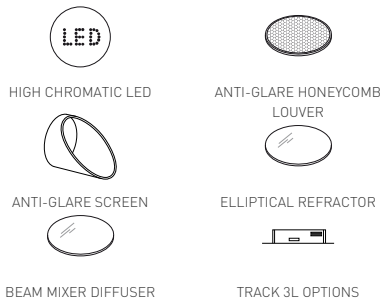

ACCESSORIES



AWARDS



Name	THOR 2 FLOOD 40° DIM DALI 4000K NT
Reference	A2262432NT
Color	Textured black
RAL	9005
Category	TRACK LIGHTS

LIGHT SOURCE

Type	LED
Gross luminous flux	4820 lm
Colour temperature	4000 K - Other K, please consult
Chromatic stability	MacAdam Step 2
Colour Rendering Index	CRI > 90
Power	36 W
Current	1050 mA
Efficacy	134 lm/W
LED lifespan	L90B10 > 55.000h

LIGHTING FIXTURE | PHOTOMETRIC DATA

Lighting efficiency	90%
Light beam angle	40°

LIGHTING FIXTURE | ELECTRICAL DATA

Driver	Included
Power values of the system	40,86 W
Frequency	50/60 Hz
Dimming	DALI
Electrical insulation class	II

OTHER DATA

Sealing	IP20
Wireless control	Please Consult
Swivel angle	90°
Rotation angle	325°
Track type	Track 3L+N Dimmable
Weight	2015 g
Packaged weight	2300 g
Packaging dimensions	368 x 171 x 184 mm
Units per package	1
Materials	Aluminium / Glass-Transparent



Among the high luminous flux spotlights in the market, Thor is the most compact that works with passive dissipation. Moreover, thanks to the in its symmetric casing situated driver and its perfectly centered center of mass, Thor can be adjusted to any position required without generating any lateral forces that might cause the track that carries the fitting to tilt.

POLAR DIAGRAM

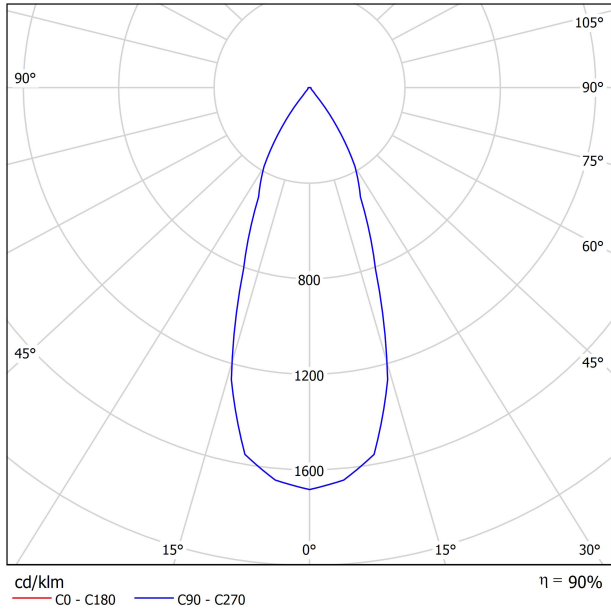

CONICAL DIAGRAM

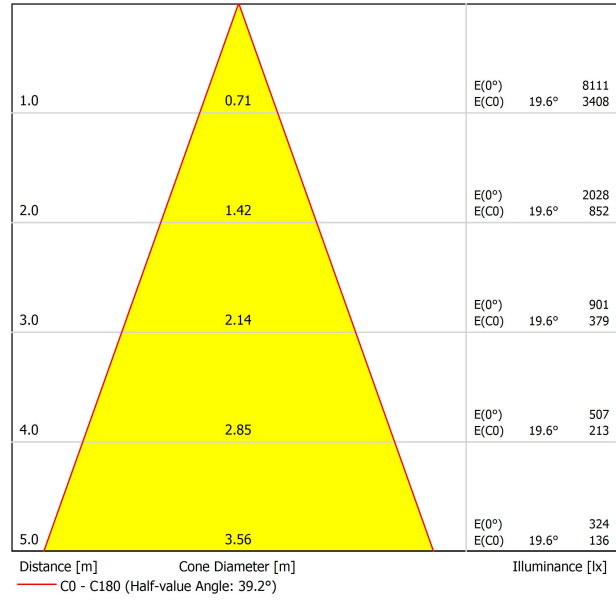

Vivid Model Colour Temperature	2700K	3000K	3500K	4000K	Light Pink
📖 Reading			•	•	
🥬 Fruits & Vegetables		•	•		
🍞 Bakery	•				
👤 Retail		•	•		
💄 Cosmetics			•	•	
🥩 Meat					•
🐟 Fish				•	
🐠 Seafood				•	•



For some of its products, Arkoslight offers the possibility to provide them with a special LED, designed to create an illumination focused on visually promoting goods or products for commercial purposes. It is a high chromaticity LED, capable of identifying the colour shades that produce a positive psychological perception of the illuminated object.

This special LED lighting source offers a much more attractive and intense colour range than a conventional LED, besides being much wider. Technically, this is possible thanks to a special LED setting that includes a «special saturation parameter», capable of highlighting the objects colours and materials in such a way that they seem more attractive within the visible light spectrum. To achieve this performance, in each case, the appropriate diode and specific phosphor coating are carefully selected.



	PRODUCT
Model	Anti-glare Honeycomb Louver
Reference	08020200
Category	Accessories
	NOT SOLD SEPARATELY.



Accessory made up of louver in the shape of a honeycomb panel to reduce glare and the effects of direct rays of vision.



	PRODUCT
Model	THOR Anti-glare Screen
Reference	08020000NT
Colour	NT ■ Textured black
Category	Accessories

Accessory screen to direct the light beam in an asymmetrical way and also to reduce glare and to spread the light laterally (suitable for wall washer applications, among others).



	PRODUCT
Model	Elliptical Refractor
Reference	08020400
Category	Accessories

NOT SOLD SEPARATELY.

Lens that modifies the light beam to achieve an elliptical shape through light refraction in its optical glass.



	PRODUCT
Model	Beam Mixer Diffuser
Reference	08050300
Category	Accessories

NOT SOLD SEPARATELY.

The Beam Mixer Diffuser is used to smooth beam artifacts caused by parabolic, Fresnel, or TIR lens collimators without significant broadening.

The unique mixing design provides superior far-field smoothing and color mixing with high on-axis brightness. Compared with traditional diffusers, it maintains higher central beam candlepower (CBCP), and produce less undesirable "field light" at higher angles.

TRACK 3L+N SURFACE & SUSPENDED

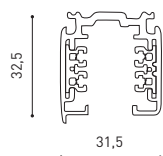

TRACK 3L 1M	A219-21-01-	B	N
TRACK 3L 2M	A219-21-02-	B	N
TRACK 3L 3M	A219-21-03-	B	N



TRACK 3L+N FLUSH MOUNTING

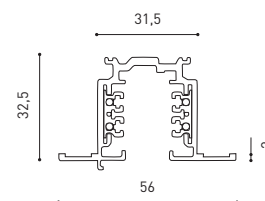
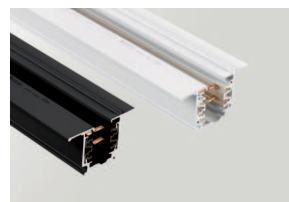

TRACK 3L FLUSH 1M	A219-22-01-	B	N
TRACK 3L FLUSH 2M	A219-22-02-	B	N
TRACK 3L FLUSH 3M	A219-22-03-	B	N

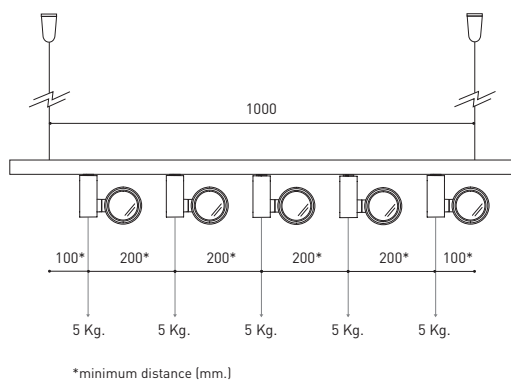

WEIGHT BEAR CAPACITY

Distancia de fijación y capacidad de carga.
Distancia de fijación recomendada l- 1000mm.

Fastening distance and loading capacity.
Recommended fastening distance l- 1000mm.

Distance de fixation et capacité de charge.
Distance de fixation recommandée l- 1000mm.

Distanza di installazione e capacità di carico.
Distanza consigliata di fissazione l- 1000mm.

Befestigungsabstand und Belastbarkeit.
Empfohlener Abstand l- 1000mm.

COLOUR | B □ RAL 9016 | N ■ RAL 9005 |

Calle N · Pol. Ind. EL OLIVERAL
46394 Ribarroja del Turia · Valencia (Spain)
Tel. +34 961 667 207 · Fax +34 961 667 054
info@arkoslight.com · www.arkoslight.com



SURFACE & SUSPENDED

FLUSH MOUNTING

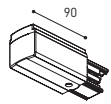

POLARITY GROOVE



TRACK 3L Live-End Connector

A219-21-04- | B | N |

A219-21-12- | B | N |

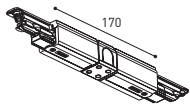

TRACK 3L Central Connector

A219-21-05- | B | N |



TRACK 3L Ceiling Kit

A219-21-06- | B | N |

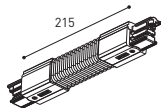

TRACK 3L Universal Angle

A219-21-07- | B | N |

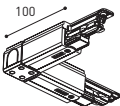

TRACK 3L 90° Angle

A219-21-08- | B | N |

A219-21-13- | B | N |

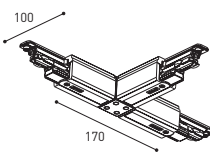

TRACK 3L T Joint

A219-21-09- | B | N |

A219-21-14- | B | N |

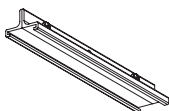

TRACK 3L Mechanical Joint

A219-21-11- | B | N |



TRACK 3L Suspension Kit

A219-21-10- | B | N |

At least 2 units needed

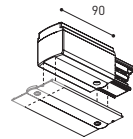

POLARITY GROOVE



TRACK 3L Live-End Connector

A219-21-04- | B | N |

A219-21-12- | B | N |

TRACK 3L FLUSH Cover Plate

A219-22-10- | B | N |

Mandatory for installation

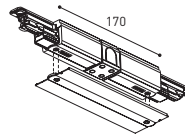

TRACK 3L Central Connector

A219-21-05- | B | N |

TRACK 3L FLUSH Cover Plate

A219-22-10- | B | N |

Mandatory for installation



TRACK 3L FLUSH Ceiling Kit

A219-22-06- | B |

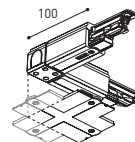

TRACK 3L 90° Angle

A219-21-08- | B | N |

A219-21-13- | B | N |

TRACK 3L FLUSH Corner Cover Plate

A219-22-11- | B | N |

Mandatory for installation

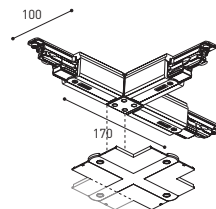

TRACK 3L T Joint

A219-21-09- | B | N |

A219-21-14- | B | N |

TRACK 3L FLUSH Corner Cover Plate

A219-22-11- | B | N |

Mandatory for installation

SURFACE & SUSP. / FLUSH MOUNTING

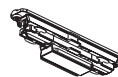

TRACK Contact Joint

A219-20-01- | B | N |



TRACK End

A219-20-02- | B | N |



TRACK Clamp Kit for M6 ROD

A219-21-21- | B |

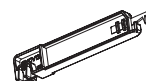

TRACK Bending Tool

A282-00-00

For tracks its length has been modified

COLOUR | B □ RAL 9016 | N ■ RAL 9005 |



Fuente de luz (LED) reemplazable por un profesional autorizado
 Replaceable (LED only) light source by an authorized professional.
 Source lumineuse (LED) remplaçable par un professionnel agréé
 Sorgente luminosa (LED) sostituibile da parte di un professionista autorizzato
 Austauschbare (LED) Lichtquelle durch einen autorisierten Fachmann



Equipo de control reemplazable por un profesional autorizado
 Replaceable control gear by an authorized professional
 Dispositif de commande remplaçable par un professionnel agréé
 Alimentatore sostituibile da parte di un professionista autorizzato
 Auswechselbares Betriebsgerät durch autorisierten Fachmann

INSTRUCCIONES PARA EL FINAL DE VIDA Y LA ELIMINACIÓN LOS COMPONENTES
 INSTRUCTIONS ON END-OF-LIFE AND COMPONENT DISPOSAL
 INSTRUCTIONS POUR LA GESTION DES COMPOSANTS EN FIN DE VIE ET LEUR MISE AU REBUT
 ISTRUZIONI PER IL FINE VITA E LO SMALTIMENTO DEI COMPONENTI
 ANWEISUNGEN ZUR ENTSORGUNG DER LEUCHTENKOMPONENTEN



Interrumpir la alimentación del aparato
 Cut the power supply to the luminaire
 Couper l'alimentation du luminaire
 Interrompere l'alimentazione dell'apparecchio
 Stromversorgung der Leuchte unterbrechen



Quitar la(s) fuente(s) de luz para el desecho
 Remove light source(s) for disposal
 Retirer la (les) source(s) lumineuse(s) pour l'élimination
 Rimuovere la/le sorgente/e di luce per lo smaltimento
 Lichtquelle(n) zur Entsorgung entfernen



Quitar la batería para el desecho
 Remove the battery for decommissioning
 Retirer la batterie pour sa mise au rebut
 Rimuovere la batteria per la dismissione
 Die Batterie ordnungsgemäß entsorgen



Quitar el equipo de control para el desecho
 Remove control gear for disposal
 Retirer le dispositif de commande pour l'élimination
 Rimuovere l'alimentatore per lo smaltimento
 Betriebsgerät zur Entsorgung ausbauen

Enviar los materiales a un centro de recogida RAEE
 Send the materials to a WEEE collection centre
 Envoyer les matériaux dans une déchetterie DEEE
 Inviare i materiali ad un centro di raccolta RAEE
 Die Materialien in einem WEEE-Zentrum entsorgen

