

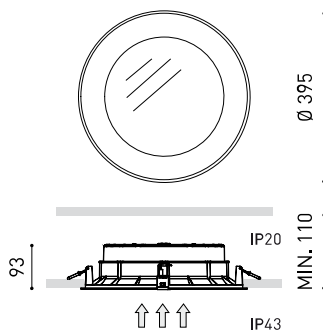

DIMENSIONES



PREMIOS



Nombre	DROP MAXI 5 4000K WT
Referencia	A2350512WT
Color	Textured white
RAL	9016
Categoría	CEILING RECESSED

Tipo	LED
Flujo Luminoso	5925 lm
Temperatura de color	4000 K
Estabilidad cromática	MacAdam Step 2
Índice de reproducción cromática	CRI > 90
Potencia	40 W
Corriente	900 mA
Eficacia	148 lm/W
Horas de Vida del LED	L80B10 > 60.000h

Eficiencia Lumínica	84%
Ángulo del haz de luz	97°

Driver	Included - Connected
Potencia del sistema	44,35 W
Tensión	220V/240V
Frecuencia	50/60 Hz
Regulación	No Dim
Clase de seguridad eléctrica	<input type="checkbox"/>

Estanqueidad	IP43
Control inalámbrico	Please Consult
Alimentación de emergencia	Please Consult
Resistencia a impactos	IK07
Medidas de empotramiento	Ø375 mm
Peso	2800 g
Peso con embalaje	3340,5 g
Dimensiones embalaje	454 x 444 x 136 mm
Unidades por embalaje	1
Materiales	Aluminium / Polymethyl Methacrylate

PRODUCTO

Nombre	DROP MAXI 5 4000K WT
Referencia	A2350512WT
Color	Textured white
RAL	9016
Categoría	CEILING RECESSED

FUENTE DE LUZ

Tipo	LED
Flujo Luminoso	5925 lm
Temperatura de color	4000 K
Estabilidad cromática	MacAdam Step 2
Índice de reproducción cromática	CRI > 90
Potencia	40 W
Corriente	900 mA
Eficacia	148 lm/W
Horas de Vida del LED	L80B10 > 60.000h

LUMINARIA | DATOS FOTOMÉTRICOS

Eficiencia Lumínica	84%
Ángulo del haz de luz	97°

LUMINARIA | DATOS ELÉCTRICOS

Driver	Included - Connected
Potencia del sistema	44,35 W
Tensión	220V/240V
Frecuencia	50/60 Hz
Regulación	No Dim
Clase de seguridad eléctrica	<input type="checkbox"/>

OTROS DATOS

Estanqueidad	IP43
Control inalámbrico	Please Consult
Alimentación de emergencia	Please Consult
Resistencia a impactos	IK07
Medidas de empotramiento	Ø375 mm
Peso	2800 g
Peso con embalaje	3340,5 g
Dimensiones embalaje	454 x 444 x 136 mm
Unidades por embalaje	1
Materiales	Aluminium / Polymethyl Methacrylate



When lit, the lighting of Drop produces an effect of erasing visually the rims of the fitting, creating the illusion of illumination which resembles that of a natural skylight.

DIAGRAMA POLAR



DIAGRAMA CÓNICO

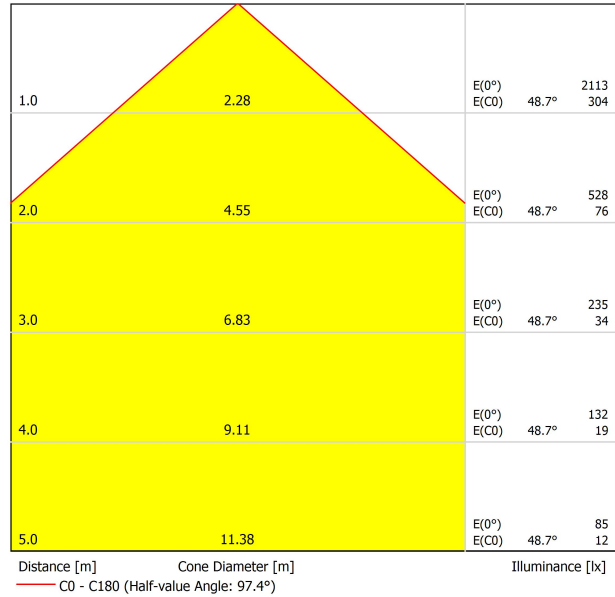

UGR

Glare Evaluation According to UGR											
ρ Ceiling		70	70	50	50	30	70	70	50	50	30
ρ Walls		50	30	50	30	30	50	30	50	30	30
ρ Floor		20	20	20	20	20	20	20	20	20	20
Room Size X Y		Viewing direction at right angles to lamp axis					Viewing direction parallel to lamp axis				
2H	2H	23.0	24.2	23.3	24.5	24.7	23.0	24.2	23.3	24.5	24.7
	3H	24.3	25.4	24.6	25.7	26.0	24.3	25.4	24.6	25.7	26.0
	4H	24.7	25.7	25.0	26.0	26.3	24.7	25.7	25.0	26.0	26.3
	6H	24.8	25.8	25.2	26.1	26.4	24.8	25.8	25.2	26.1	26.4
	8H	24.8	25.7	25.2	26.1	26.4	24.8	25.7	25.2	26.1	26.4
4H	2H	23.5	24.5	23.8	24.8	25.1	23.5	24.5	23.8	24.8	25.1
	3H	24.9	25.8	25.3	26.1	26.5	24.9	25.8	25.3	26.1	26.5
	4H	25.4	26.2	25.8	26.5	26.9	25.4	26.2	25.8	26.5	26.9
	6H	25.6	26.3	26.0	26.6	27.0	25.6	26.3	26.0	26.6	27.0
	8H	25.6	26.3	26.1	26.6	27.1	25.6	26.3	26.1	26.6	27.1
8H	2H	25.7	26.2	26.1	26.6	27.1	25.7	26.2	26.1	26.6	27.1
	4H	25.5	26.1	26.0	26.5	27.0	25.5	26.1	26.0	26.5	27.0
	6H	25.8	26.3	26.2	26.7	27.2	25.8	26.3	26.2	26.7	27.2
	8H	25.9	26.3	26.3	26.7	27.2	25.9	26.3	26.3	26.7	27.2
	12H	25.9	26.3	26.4	26.8	27.3	25.9	26.3	26.4	26.8	27.3
12H	4H	25.5	26.1	26.0	26.5	26.9	25.5	26.1	26.0	26.5	26.9
	6H	25.8	26.2	26.3	26.7	27.1	25.8	26.2	26.3	26.7	27.1
	8H	25.9	26.3	26.4	26.7	27.2	25.9	26.3	26.4	26.7	27.2
Variation of the observer position for the luminaire distances S											
S = 1.0H		+0.2 / -0.2					+0.2 / -0.2				
S = 1.5H		+0.3 / -0.6					+0.3 / -0.6				
S = 2.0H		+0.7 / -1.2					+0.7 / -1.2				
Standard table		BK04					BK04				
Correction Summand		1.9					1.9				
Corrected Glare Indices referring to 5925lm Total Luminous Flux											



Fuente de luz (LED) reemplazable por un profesional autorizado

Replaceable (LED only) light source by an authorized professional.

Source lumineuse (LED) remplaçable par un professionnel agréé

Sorgente luminosa (LED) sostituibile da parte di un professionista autorizzato

Austauschbare (LED) Lichtquelle durch einen autorisierten Fachmann



Equipo de control reemplazable por un profesional autorizado

Replaceable control gear by an authorized professional

Dispositif de commande remplaçable par un professionnel agréé

Alimentatore sostituibile da parte di un professionista autorizzato

Auswechselbares Betriebsgerät durch autorisierten Fachmann

INSTRUCCIONES PARA EL FINAL DE VIDA Y LA ELIMINACIÓN LOS COMPONENTES
 INSTRUCTIONS ON END-OF-LIFE AND COMPONENT DISPOSAL
 INSTRUCTIONS POUR LA GESTION DES COMPOSANTS EN FIN DE VIE ET LEUR MISE AU REBUT
 ISTRUZIONI PER IL FINE VITA E LO SMALTIMENTO DEI COMPONENTI
 ANWEISUNGEN ZUR ENTSORGUNG DER LEUCHTENKOMPONENTEN



Interrumpir la alimentación del aparato
 Cut the power supply to the luminaire
 Couper l'alimentation du luminaire
 Interrompere l'alimentazione dell'apparecchio
 Stromversorgung der Leuchte unterbrechen



Quitar la(s) fuente(s) de luz para el desecho
 Remove light source(s) for disposal
 Retirer la (les) source(s) lumineuse(s) pour l'élimination
 Rimuovere la/le sorgente/e di luce per lo smaltimento
 Lichtquelle(n) zur Entsorgung entfernen



Quitar la batería para el desecho
 Remove the battery for decommissioning
 Retirer la batterie pour sa mise au rebut
 Rimuovere la batteria per la dismissione
 Die Batterie ordnungsgemäß entsorgen



Quitar el equipo de control para el desecho
 Remove control gear for disposal
 Retirer le dispositif de commande pour l'élimination
 Rimuovere l'alimentatore per lo smaltimento
 Betriebsgerät zur Entsorgung ausbauen



Enviar los materiales a un centro de recogida RAEE
 Send the materials to a WEEE collection centre
 Envoyer les matériaux dans une déchetterie DEEE
 Inviare i materiali ad un centro di raccolta RAEE
 Die Materialien in einem WEEE-Zentrum entsorgen

