

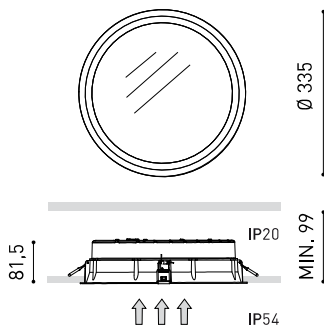

DIMENSIONS



Name	DEEP MAXI 4 IP54 4000K WT
Reference	A2481412WT
Color	Textured white
RAL	9016
Category	CEILING RECESSED

PRODUCT

Type	LED
Gross luminous flux	4775 lm
Colour temperature	4000 K
Chromatic stability	MacAdam Step 2
Colour Rendering Index	CRI > 90
Power	31 W
Current	700 mA
Efficacy	154 lm/W
LED lifespan	L80B10 > 60.000h

LIGHT SOURCE

Lighting efficiency	85%
Light beam angle	99°

LIGHTING FIXTURE | PHOTOMETRIC DATA

Driver	Included - Connected
Power values of the system	35,35 W
Frequency	50/60 Hz
Dimming	No Dim
Electrical insulation class	□

LIGHTING FIXTURE | ELECTRICAL DATA

Sealing	IP54
Wireless control	Please Consult
Emergency power supply	Please Consult
Impact resistance	IK07
Recess measurements	Ø320 mm
Weight	2010 g
Packaged weight	2455,9 g
Packaging dimensions	420 x 370 x 105 mm
Units per package	1
Materials	Aluminium / Polymethyl Methacrylate

OTHER DATA



Deep is a LED downlight for general lighting functions whose main feature is its attractive aspect, with the diffuser considerably set back with respect to the plane of the perimeter frame.

POLAR DIAGRAM



CONICAL DIAGRAM

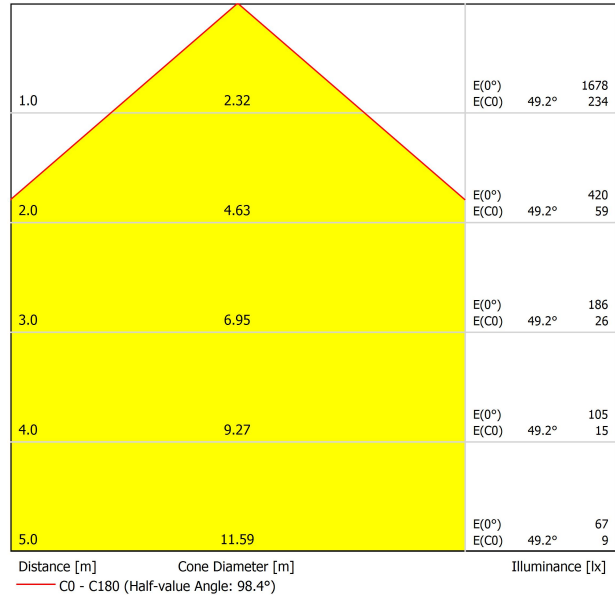

UGR

Glare Evaluation According to UGR											
ρ Ceiling	70	70	50	50	30	70	70	50	50	30	
ρ Walls	50	30	50	30	30	50	30	50	30	30	
ρ Floor	20	20	20	20	20	20	20	20	20	20	
Room Size X Y		Viewing direction at right angles to lamp axis					Viewing direction parallel to lamp axis				
2H	2H	22.2	23.5	22.5	23.7	23.9	22.2	23.5	22.5	23.7	23.9
	3H	23.7	24.8	24.0	25.0	25.3	23.7	24.8	24.0	25.0	25.3
	4H	24.1	25.2	24.4	25.4	25.7	24.1	25.2	24.4	25.4	25.7
	6H	24.4	25.3	24.7	25.6	25.9	24.4	25.3	24.7	25.6	25.9
	8H	24.4	25.4	24.8	25.7	26.0	24.4	25.4	24.8	25.7	26.0
4H	2H	22.7	23.8	23.0	24.0	24.3	22.7	23.8	23.0	24.0	24.3
	3H	24.3	25.2	24.7	25.5	25.9	24.3	25.2	24.7	25.5	25.9
	4H	24.9	25.7	25.3	26.0	26.4	24.9	25.7	25.3	26.0	26.4
	6H	25.2	25.9	25.7	26.3	26.7	25.2	25.9	25.7	26.3	26.7
	8H	25.3	26.0	25.8	26.4	26.8	25.3	26.0	25.8	26.4	26.8
8H	2H	25.4	26.0	25.9	26.4	26.8	25.4	26.0	25.9	26.4	26.8
	4H	25.1	25.7	25.5	26.1	26.5	25.1	25.7	25.5	26.1	26.5
	6H	25.5	26.0	26.0	26.5	26.9	25.5	26.0	26.0	26.5	26.9
	8H	25.7	26.1	26.2	26.6	27.1	25.7	26.1	26.2	26.6	27.1
	12H	25.8	26.2	26.3	26.7	27.2	25.8	26.2	26.3	26.7	27.2
12H	4H	25.1	25.7	25.5	26.1	26.5	25.1	25.7	25.5	26.1	26.5
	6H	25.6	26.0	26.0	26.4	26.9	25.6	26.0	26.0	26.4	26.9
	8H	25.7	26.1	26.2	26.6	27.1	25.7	26.1	26.2	26.6	27.1
Variation of the observer position for the luminaire distances S											
S = 1.0H	+0.2 / -0.2					+0.2 / -0.2					
S = 1.5H	+0.3 / -0.6					+0.3 / -0.6					
S = 2.0H	+0.6 / -1.0					+0.6 / -1.0					
Standard table	BK04					BK04					
Correction Summand	2.2					2.2					
Corrected Glare Indices referring to 4775lm Total Luminous Flux											



Fuente de luz (LED) reemplazable por un profesional autorizado
 Replaceable (LED only) light source by an authorized professional.
 Source lumineuse (LED) remplaçable par un professionnel agréé
 Sorgente luminosa (LED) sostituibile da parte di un professionista autorizzato
 Austauschbare (LED) Lichtquelle durch einen autorisierten Fachmann



Equipo de control reemplazable por un profesional autorizado
 Replaceable control gear by an authorized professional
 Dispositif de commande remplaçable par un professionnel agréé
 Alimentatore sostituibile da parte di un professionista autorizzato
 Auswechselbares Betriebsgerät durch autorisierten Fachmann

INSTRUCCIONES PARA EL FINAL DE VIDA Y LA ELIMINACIÓN LOS COMPONENTES
 INSTRUCTIONS ON END-OF-LIFE AND COMPONENT DISPOSAL
 INSTRUCTIONS POUR LA GESTION DES COMPOSANTS EN FIN DE VIE ET LEUR MISE AU REBUT
 ISTRUZIONI PER IL FINE VITA E LO SMALTIMENTO DEI COMPONENTI
 ANWEISUNGEN ZUR ENTSORGUNG DER LEUCHTENKOMPONENTEN



Interrumpir la alimentación del aparato
 Cut the power supply to the luminaire
 Couper l'alimentation du luminaire
 Interrompere l'alimentazione dell'apparecchio
 Stromversorgung der Leuchte unterbrechen



Quitar la(s) fuente(s) de luz para el desecho
 Remove light source(s) for disposal
 Retirer la (les) source(s) lumineuse(s) pour l'élimination
 Rimuovere la/le sorgente/e di luce per lo smaltimento
 Lichtquelle(n) zur Entsorgung entfernen



Quitar la batería para el desecho
 Remove the battery for decommissioning
 Retirer la batterie pour sa mise au rebut
 Rimuovere la batteria per la dismissione
 Die Batterie ordnungsgemäß entsorgen



Quitar el equipo de control para el desecho
 Remove control gear for disposal
 Retirer le dispositif de commande pour l'élimination
 Rimuovere l'alimentatore per lo smaltimento
 Betriebsgerät zur Entsorgung ausbauen

Enviar los materiales a un centro de recogida RAEE
 Send the materials to a WEEE collection centre
 Envoyer les matériaux dans une déchetterie DEEE
 Inviare i materiali ad un centro di raccolta RAEE
 Die Materialien in einem WEEE-Zentrum entsorgen

