

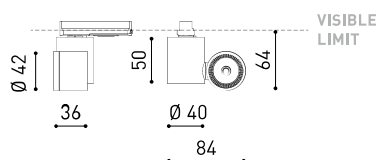

GRÖÖE



ZUBEHÖR



HIGH CHROMATIC LED



BEAM MIXER DIFFUSER



ANTI-GLARE HONEYCOMB LOUVER



TRACK 1L OPTIONS

PREISE

Silver Delta
ADI Awards
2016DESIGN
AWARD
2017PREMIO
ADCV 2017
OROGOOD
DESIGN

PRODUKT

Name	IO 20° 3000K WT
Artikelnummer	A2620011WT
Farbe	Weiß strukturiert
RAL	9016
Kategorie	TRACK LIGHTS

LICHTQUELLE

Typ	LED
Bruttolichtstrom	505 lm
Farbtemperatur	3000 K
Farbstabilität	MacAdam Step 2
Farbwiedergabeindex	CRI > 90
Leistung	4,5 W
Stromstärke	500 mA
Lichtausbeute	112 lm/W
Nutzlebensdauer der LED in Betriebsstunden	L90B10 > 55.000h

LEUCHE | PHOTOMETRISCHE DATEN

Leuchtenwirkungsgrad (LOR)	92%
Abstrahlwinkel	20°

LEUCHE | ELEKTRISCHE DATEN

Driver	Inklusiv
Leistungswerte des Systems	5,80 W
Spannung	220V/240V
Frequenz	50/60 Hz
Helligkeitssteuerung	No Dim
Schutzklasse	⚡

ANDERE DATEN

Dichtigkeit	IP20
Schwenkwinkel	325°
Drehwinkel	355°
Schiementyp	Track 1L
Gewicht	160 g
Gewicht inkl. Verpackung	205,2 g
Abmessungen der Verpackung	116 x 105,5 x 56 mm
Stück pro Verpackung	1
Materialien	Aluminium / Polycarbonat



iO ist ein Miniatur-LED-Strahler, der so klein ist, dass er in eine Handfläche passt. Er ist für den Einsatz als Akzentbeleuchtung gedacht und seine geringen Abmessungen ermöglichen die Installation in Vitrinen, Schaufenstern und kleinen Räumen, ohne aufdringlich zu wirken. Ausgelegt für die Schieneninstallation, bietet er sämtliche Leistungen der besten LED-Strahler konzentriert in einem minimalistischen, hyperreduzierten Design.

POLAR-KOORDINATEN DIAGRAMM



KEGELDIAGRAMM

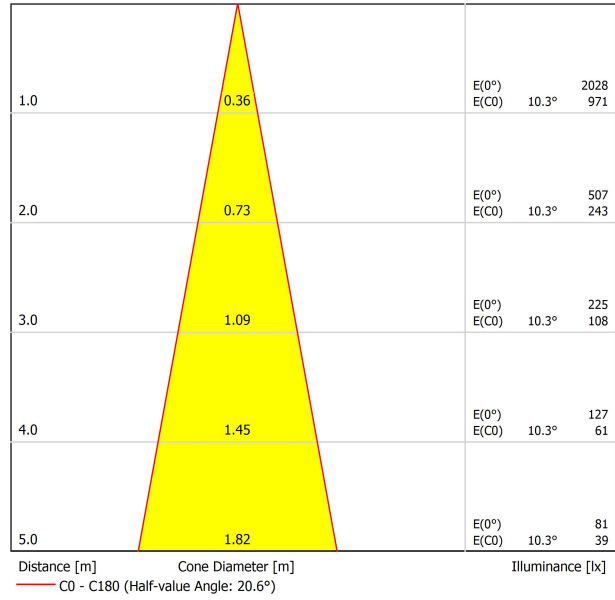

FÜR DIE PRODUKTPRÄSENTATION

Vivid Model Colour Temperature	2700K	3000K	3500K	4000K	Light Pink
📖 Reading			•	•	
🥬 Fruits & Vegetables		•	•		
🍞 Bakery	•				
👤 Retail		•	•		
💄 Cosmetics			•	•	
🥩 Meat					•
🐟 Fish				•	
🐠 Seafood				•	•



Einige der Produkte von Arkoslight können mit einer Spezial-LED für die visuelle Bewerbung von Waren und Produkten zur Verkaufsförderung ausgerüstet werden.

Dabei handelt es sich um eine hochchromatische LED, um Farbtöne hervorzuheben, die positive psychologische Wahrnehmung des beleuchteten Objekts begünstigen.

Diese spezielle LED-Lichtquelle bietet eine ansprechendere und intensivere Farbpalette als eine herkömmliche LED. Dies wird durch die Konfiguration der LED nach einem "speziellen Sättigungsparameter" erreicht, der Farben und Textur der Objekte innerhalb des sichtbaren Spektralbereichs attraktiver erscheinen lässt. Dafür wird die jeweils zweckdienliche Diode und spezifische Phosphorbeschichtung gewählt.



	PRODUCT
Model	Beam Mixer Diffuser
Reference	08050100
Category	Accessories

WIRD NICHT SEPARAT VERKAUFT.

Der Strahlenmischdiffusor wird verwendet, um durch parabolische, Fresnel- oder TIR-Linsen-Kollimatoren verursachte Strahlenartefakte ohne wesentliche Ausdehnung zu glätten.

Das einzigartige Mischungskonzeption sorgt für hochwertige Fernfeldglättung und Farbmischung bei hoher on-axis-Helligkeit. Im Vergleich zu herkömmlichen Diffusoren bewahrt er eine höhere Lichtstärkenspitze (CBCP) und ruft bei größeren Winkeln weniger unerwünschte "Lichtfelder" hervor.



	PRODUCT
Model	Anti-glare Honeycomb Louver
Reference	08060000WT
Colour	WT □ Textured white
Category	Accessories

WIRD NICHT SEPARAT VERKAUFT.



Zubehör in Form eines Wabengitters, um die Blendung und den direkten Einfall der Strahlen in die Augen zu reduzieren.

SURFACE & SUSPENDED

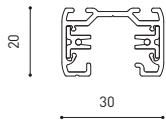
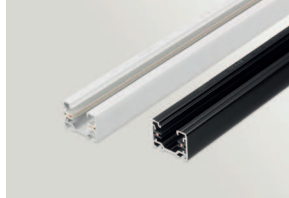

TRACK 1L 1m	A264-01-00- B N
TRACK 1L 2m	A264-02-00- B N
TRACK 1L 3m	A264-03-00- B N



POLARITY GROOVE



	TRACK 1L Live-End Connector
A264-00-01- B N	
	A264-00-02- B N



TRACK 1L Contact Joint
A264-00-04- B N

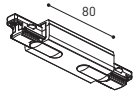

TRACK 1L Central Connector
A264-00-03- B N



TRACK 1L End
A264-00-13- B N

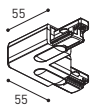

	TRACK 1L 90° Angle
A264-00-06- B N	
	A264-00-07- B N

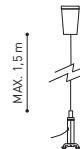

TRACK 1L Suspension Kit
A264-00-14- WT NT
At least 2 units needed

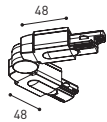

TRACK 1L Corner connector
A264-00-15- B N

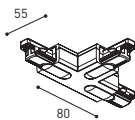

	TRACK 1L T-Joint
A264-00-16- B N	
	A264-00-17- B N

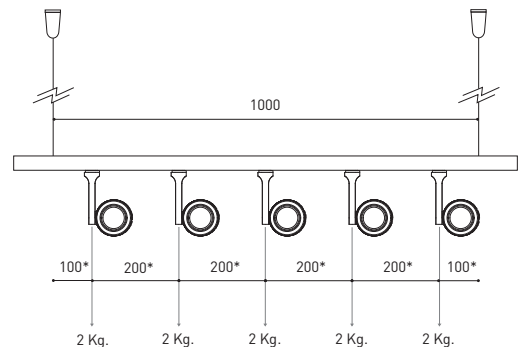

*minimum distance (mm.)

COLOUR | B □ RAL 9016 | N ■ RAL 9005 | WT □ RAL 9016 | NT ■ RAL 9005 |

FLUSH MOUNTING



TRACK 1L FLUSH 1m	A264-11-00- B N
TRACK 1L FLUSH 2m	A264-12-00- B N
TRACK 1L FLUSH 3m	A264-13-00- B N



POLARITY GROOVE



TRACK 1L FLUSH Live-End Connector

A264-00-01- B N
A264-00-02- B N

TRACK 1L FLUSH Cover Plate

A264-10-19- B N

Mandatory for installation



TRACK 1L FLUSH Central Connector

A264-00-03- B N

TRACK 1L FLUSH Corner Cover Plate

A264-10-20- B N

Mandatory for installation



TRACK 1L FLUSH 90° Angle

A264-00-06- B N
A264-00-07- B N

TRACK 1L FLUSH Corner Cover Plate

A264-10-20- B N

Mandatory for installation

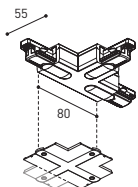

TRACK 1L FLUSH T-Joint

A264-00-16- B N
A264-00-17- B N

TRACK 1L FLUSH Corner Cover Plate

A264-10-20- B N

Mandatory for installation



TRACK 1L Contact Joint

A264-00-04- B N



TRACK 1L End

A264-00-13- B N



TRACK 1L FLUSH Suspension Kit

A264-10-15

For wire 1,5 mm [Not included]



*minimum distance [mm.]

COLOUR | B □ RAL 9016 | N ■ RAL 9005 |





Fuente de luz (LED) reemplazable por un profesional autorizado

Replaceable (LED only) light source by an authorized professional.

Source lumineuse (LED) remplaçable par un professionnel agréé

Sorgente luminosa (LED) sostituibile da parte di un professionista autorizzato

Austauschbare (LED) Lichtquelle durch einen autorisierten Fachmann



Equipo de control reemplazable por un profesional autorizado

Replaceable control gear by an authorized professional

Dispositif de commande remplaçable par un professionnel agréé

Alimentatore sostituibile da parte di un professionista autorizzato

Auswechselbares Betriebsgerät durch autorisierten Fachmann

INSTRUCCIONES PARA EL FINAL DE VIDA Y LA ELIMINACIÓN LOS COMPONENTES
 INSTRUCTIONS ON END-OF-LIFE AND COMPONENT DISPOSAL
 INSTRUCTIONS POUR LA GESTION DES COMPOSANTS EN FIN DE VIE ET LEUR MISE AU REBUT
 ISTRUZIONI PER IL FINE VITA E LO SMALTIMENTO DEI COMPONENTI
 ANWEISUNGEN ZUR ENTSORGUNG DER LEUCHTENKOMPONENTEN



Interrumpir la alimentación del aparato
 Cut the power supply to the luminaire
 Couper l'alimentation du luminaire
 Interrompere l'alimentazione dell'apparecchio
 Stromversorgung der Leuchte unterbrechen



Quitar la(s) fuente(s) de luz para el desecho
 Remove light source(s) for disposal
 Retirer la (les) source(s) lumineuse(s) pour l'élimination
 Rimuovere la/le sorgente/e di luce per lo smaltimento
 Lichtquelle(n) zur Entsorgung entfernen



Quitar la batería para el desecho
 Remove the battery for decommissioning
 Retirer la batterie pour sa mise au rebut
 Rimuovere la batteria per la dismissione
 Die Batterie ordnungsgemäß entsorgen



Quitar el equipo de control para el desecho
 Remove control gear for disposal
 Retirer le dispositif de commande pour l'élimination
 Rimuovere l'alimentatore per lo smaltimento
 Betriebsgerät zur Entsorgung ausbauen



Enviar los materiales a un centro de recogida RAEE
 Send the materials to a WEEE collection centre
 Envoyer les matériaux dans une déchetterie DEEE
 Inviare i materiali ad un centro di raccolta RAEE
 Die Materialien in einem WEEE-Zentrum entsorgen

