

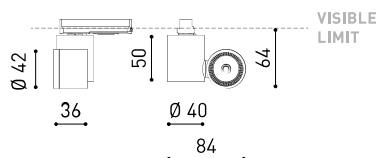

### DIMENSIONES



### ACCESORIOS



HIGH CHROMATIC LED



BEAM MIXER DIFFUSER



ANTI-GLARE HONEYCOMB LOUVER



TRACK 1L OPTIONS

### PREMIOS

Silver Delta  
ADI Awards  
2016DESIGN  
AWARD  
2017PREMIO  
ADCV 2017  
OROGOOD  
DESIGN

### PRODUCTO

Nombre	IO 20° 3000K WT
Referencia	A2620011WT
Color	Textured white
RAL	9016
Categoría	TRACKLIGHTS

### FUENTE DE LUZ

Tipo	LED
Flujo Luminoso	505 lm
Temperatura de color	3000 K
Estabilidad cromática	MacAdam Step 2
Índice de reproducción cromática	CRI >90
Potencia	4,5 W
Corriente	500 mA
Eficacia	112 lm/W
Horas de Vida del LED	L90B10 >55.000h

### LUMINARIA | DATOS FOTOMÉTRICOS

Eficiencia Lumínica	92%
Ángulo del haz de luz	20°

### LUMINARIA | DATOS ELÉCTRICOS

Driver	Included
Potencia del sistema	5,80 W
Tensión	220V/240V
Frecuencia	50/60 Hz
Regulación	No Dim
Clase de seguridad eléctrica	⚡

### OTROS DATOS

Estanqueidad	IP20
Ángulo de basculación	325°
Ángulo de giro	355°
Tipo de carril	Track 1L
Peso	160 g
Peso con embalaje	205,2 g
Dimensiones embalaje	116 x 105,5 x 56 mm
Unidades por embalaje	1
Materiales	Aluminium / Polycarbonate



iO is a LED spotlight miniaturised in a fixture that is so small that it fits on the palm of your hand. Designed for accent lighting applications, its small dimensions mean it can be fitted in display cabinets, shop windows and small places without generating an invasive presence on the scene. Created to be placed on a track, it offers all the features of concentrated LED spotlights with a minimalist and hyper-reduced design.

DIAGRAMA POLAR



DIAGRAMA CÓNICO



Vivid Model Colour Temperature	2700K	3000K	3500K	4000K	Light Pink
📖 Reading			•	•	
🥬 Fruits & Vegetables		•	•		
🍞 Bakery	•				
👤 Retail		•	•		
💄 Cosmetics			•	•	
🥩 Meat					•
🐟 Fish				•	
🐠 Seafood				•	•

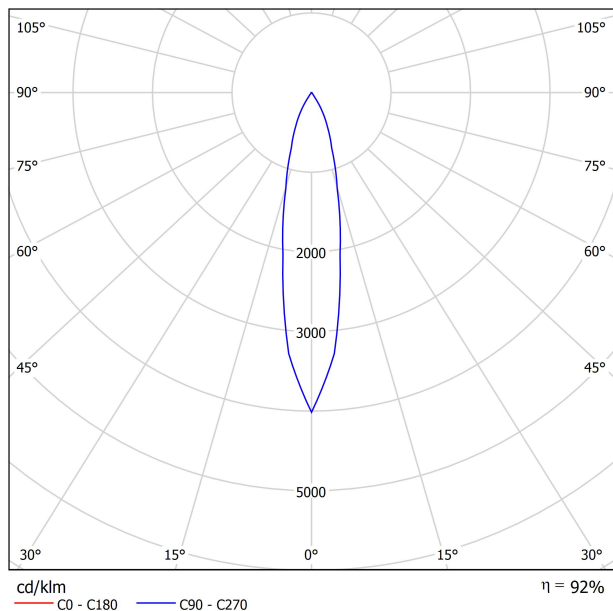
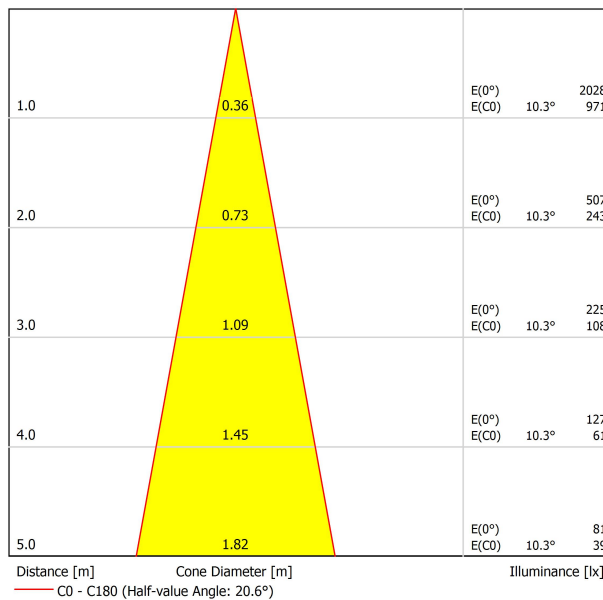

For some of its products, Arkoslight offers the possibility to provide them with a special LED, designed to create an illumination focused on visually promoting goods or products for commercial purposes. It is a high chromaticity LED, capable of identifying the colour shades that produce a positive psychological perception of the illuminated object.

This special LED lighting source offers a much more attractive and intense colour range than a conventional LED, besides being much wider. Technically, this is possible thanks to a special LED setting that includes a «special saturation parameter», capable of highlighting the objects colours and materials in such a way that they seem more attractive within the visible light spectrum. To achieve this performance, in each case, the appropriate diode and specific phosphor coating are carefully selected.



	PRODUCT
Model	Beam Mixer Diffuser
Reference	08050100
Category	Accessories

NOT SOLD SEPARATELY.

The Beam Mixer Diffuser is used to smooth beam artifacts caused by parabolic, Fresnel, or TIR lens collimators without significant broadening.

The unique mixing design provides superior far-field smoothing and color mixing with high on-axis brightness. Compared with traditional diffusers, it maintains higher central beam candlepower (CBCP), and produce less undesirable "field light" at higher angles.



	PRODUCT
Model	Anti-glare Honeycomb Louver
Reference	08060000WT
Colour	WT □   Textured white
Category	Accessories
	NOT SOLD SEPARATELY.



Accessory made up of louver in the shape of a honeycomb panel to reduce glare and the effects of direct rays of vision.

SURFACE & SUSPENDED

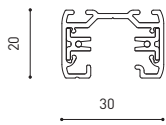

TRACK 1L 1m	A264-01-00-   B   N
TRACK 1L 2m	A264-02-00-   B   N
TRACK 1L 3m	A264-03-00-   B   N



POLARITY GROOVE

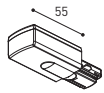

<b>TRACK 1L Live-End Connector</b>
A264-00-01-   B   N
A264-00-02-   B   N

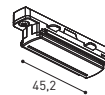

<b>TRACK 1L Contact Joint</b>
A264-00-04-   B   N

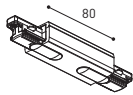

<b>TRACK 1L Central Connector</b>
A264-00-03-   B   N



<b>TRACK 1L End</b>
A264-00-13-   B   N

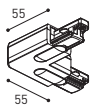

<b>TRACK 1L 90° Angle</b>
A264-00-06-   B   N
A264-00-07-   B   N

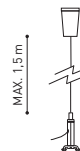

<b>TRACK 1L Suspension Kit</b>
A264-00-14-   WT   NT
At least 2 units needed

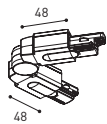

<b>TRACK 1L Corner connector</b>
A264-00-15-   B   N

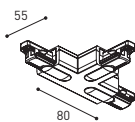

<b>TRACK 1L T-Joint</b>
A264-00-16-   B   N
A264-00-17-   B   N

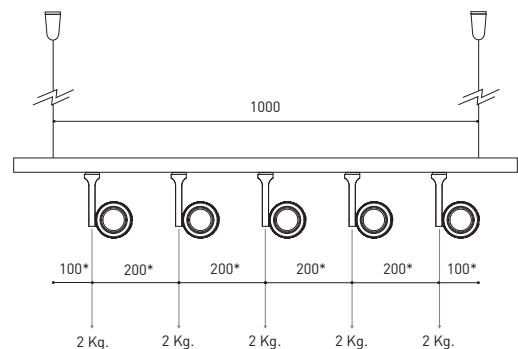

\*minimum distance (mm.)

COLOUR | B □ RAL 9016 | N ■ RAL 9005 | WT □ RAL 9016 | NT ■ RAL 9005 |

FLUSH MOUNTING

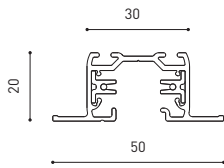
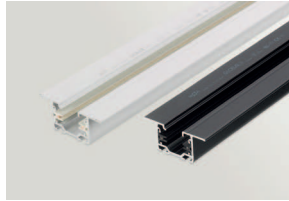

TRACK 1L FLUSH 1m	A264-11-00-   B   N
TRACK 1L FLUSH 2m	A264-12-00-   B   N
TRACK 1L FLUSH 3m	A264-13-00-   B   N



POLARITY GROOVE

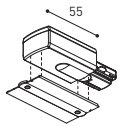

TRACK 1L FLUSH Live-End Connector

A264-00-01-   B   N
A264-00-02-   B   N

TRACK 1L FLUSH Cover Plate

A264-10-19-   B   N
---------------------

Mandatory for installation

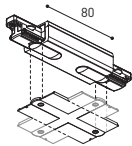

TRACK 1L FLUSH Central Connector

A264-00-03-   B   N
---------------------

TRACK 1L FLUSH Corner Cover Plate

A264-10-20-   B   N
---------------------

Mandatory for installation

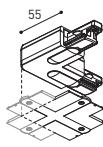

TRACK 1L FLUSH 90° Angle

A264-00-06-   B   N
A264-00-07-   B   N

TRACK 1L FLUSH Corner Cover Plate

A264-10-20-   B   N
---------------------

Mandatory for installation

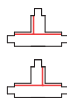
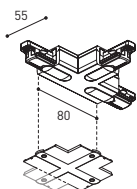

TRACK 1L FLUSH T-Joint

A264-00-16-   B   N
A264-00-17-   B   N

TRACK 1L FLUSH Corner Cover Plate

A264-10-20-   B   N
---------------------

Mandatory for installation

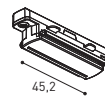

TRACK 1L Contact Joint

A264-00-04-   B   N
---------------------



TRACK 1L End

A264-00-13-   B   N
---------------------



TRACK 1L FLUSH Suspension Kit

A264-10-15
------------

For wire 1,5 mm [Not included]

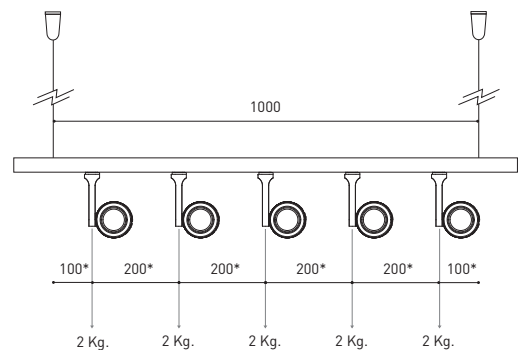

\*minimum distance [mm.]

COLOUR | B □ RAL 9016 | N ■ RAL 9005 |



Fuente de luz (LED) reemplazable por un profesional autorizado

Replaceable (LED only) light source by an authorized professional.

Source lumineuse (LED) remplaçable par un professionnel agréé

Sorgente luminosa (LED) sostituibile da parte di un professionista autorizzato

Austauschbare (LED) Lichtquelle durch einen autorisierten Fachmann



Equipo de control reemplazable por un profesional autorizado

Replaceable control gear by an authorized professional

Dispositif de commande remplaçable par un professionnel agréé

Alimentatore sostituibile da parte di un professionista autorizzato

Auswechselbares Betriebsgerät durch autorisierten Fachmann

INSTRUCCIONES PARA EL FINAL DE VIDA Y LA ELIMINACIÓN LOS COMPONENTES  
 INSTRUCTIONS ON END-OF-LIFE AND COMPONENT DISPOSAL  
 INSTRUCTIONS POUR LA GESTION DES COMPOSANTS EN FIN DE VIE ET LEUR MISE AU REBUT  
 ISTRUZIONI PER IL FINE VITA E LO SMALTIMENTO DEI COMPONENTI  
 ANWEISUNGEN ZUR ENTSORGUNG DER LEUCHTENKOMPONENTEN



Interrumpir la alimentación del aparato  
 Cut the power supply to the luminaire  
 Couper l'alimentation du luminaire  
 Interrompere l'alimentazione dell'apparecchio  
 Stromversorgung der Leuchte unterbrechen



Quitar la(s) fuente(s) de luz para el desecho  
 Remove light source(s) for disposal  
 Retirer la (les) source(s) lumineuse(s) pour l'élimination  
 Rimuovere la/le sorgente/e di luce per lo smaltimento  
 Lichtquelle(n) zur Entsorgung entfernen



Quitar la batería para el desecho  
 Remove the battery for decommissioning  
 Retirer la batterie pour sa mise au rebut  
 Rimuovere la batteria per la dismissione  
 Die Batterie ordnungsgemäß entsorgen



Quitar el equipo de control para el desecho  
 Remove control gear for disposal  
 Retirer le dispositif de commande pour l'élimination  
 Rimuovere l'alimentatore per lo smaltimento  
 Betriebsgerät zur Entsorgung ausbauen



Enviar los materiales a un centro de recogida RAEE  
 Send the materials to a WEEE collection centre  
 Envoyer les matériaux dans une déchetterie DEEE  
 Inviare i materiali ad un centro di raccolta RAEE  
 Die Materialien in einem WEEE-Zentrum entsorgen

