

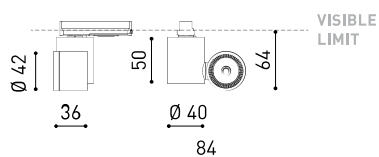

DIMENSIONI



ACCESSORI



HIGH CHROMATIC LED



BEAM MIXER DIFFUSER



ANTI-GLARE HONEYCOMB LOUVER



TRACK 1L OPTIONS

PREMI

Silver Delta
ADI Awards
2016DESIGN
AWARD
2017PREMIO
ADCV 2017
OROGOOD
DESIGN

PRODOTTO

Nome	IO 20° 3000K WT
Articolo	A2620011WT
Colore	Bianco Strutturato
RAL	9016
Categoria	TRACK LIGHTS

SORGENTE DI LUCE

Tipo	LED
Flusso luminoso lordo	505 lm
Temperatura di colore	3000 K
Stabilità cromatica	MacAdam Step 2
Indice di Riproduzione Cromatica	CRI > 90
Potenza	4,5 W
Corrente	500 mA
Efficienza	112 lm/W
Ore di vita del LED	L90B10 > 55.000h

APPARECCHIO | DATI FOTOMETRICI

Efficienza luminosa	92%
Angolo del fascio di luce	20°

APPARECCHIO | DATI ELETTRICI

Driver	Incluso
Valori di potenza del sistema	5,80 W
Tensione	220V/240V
Frequenza	50/60 Hz
Regolazione	No Dim
Classe di isolamento elettrico	⊕

ALTRI DATI

Tenuta stagna	IP20
Angolo di oscillazione	325°
Angolo di rotazione	355°
Tipo de carril	Track 1L
Peso	160 g
Peso compresso l'imballaggio	205,2 g
Dimensioni dell'imballaggio	116 x 105,5 x 56 mm
Unità per imballaggio	1
Materiali	Alluminio / Polycarbonato



iO è un proiettore LED in miniatura, costituito da un pezzo così piccolo da entrare nel palmo di una mano. Concepito per illuminazioni d'effetto, le sue ridotte dimensioni ne consentono l'installazione in vetrine, espositori e piccoli spazi, senza essere invasivo sulla scena. Creato per essere ubicato su binario, offre tutte le prestazioni dei migliori proiettori LED, concentrati in un design minimalista ed estremamente ridotto.

DIAGRAMMA DI ABBAGLIAMENTO POLARE



DIAGRAMMA CONICO

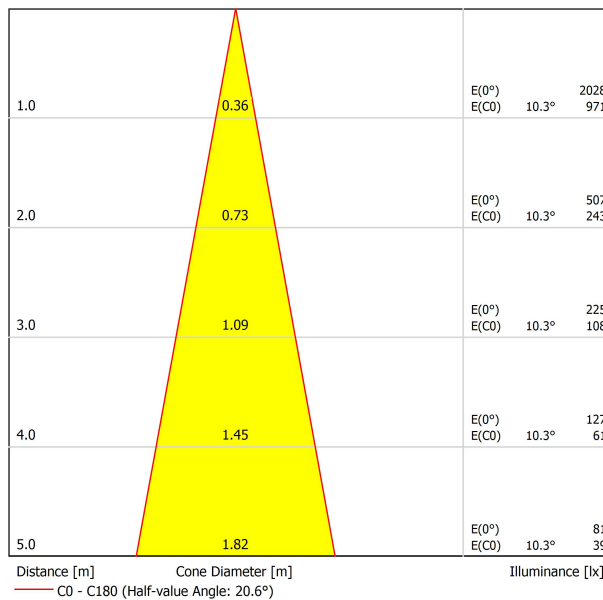

PER PRESENTAZIONE COMMERCIALE DEL PRODOTTO

Vivid Model Colour Temperature	2700K	3000K	3500K	4000K	Light Pink
📖 Reading			•	•	
🥬 Fruits & Vegetables		•	•		
🍞 Bakery	•				
👤 Retail		•	•		
💄 Cosmetics			•	•	
🍖 Meat					•
🐟 Fish				•	
🐠 Seafood				•	•



Arkoslight offre su alcuni dei suoi prodotti la possibilità di dotarli di un LED speciale per illuminazione orientata alla promozione visiva di beni e prodotti a scopo commerciale.

Si tratta di un LED ad alta cromaticità che mette in rilievo le tonalità che favoriscono la percezione psicologica positiva dell'oggetto illuminato.

Questa sorgente di luce LED speciale offre una gamma di colori più attraenti e intensi, superiore a quella che può offrire un LED convenzionale. Ciò si ottiene grazie alla configurazione del LED secondo un "parametro speciale di saturazione" che fa in modo che i colori e la texture degli oggetti appaiano più attraenti all'interno dello spettro di luce visibile. A tale scopo si seleziona, in ciascun caso, l'apposito diodo e il suo fosforo di rivestimento specifico.



	PRODUCT
Model	Beam Mixer Diffuser
Reference	08050100
Category	Accessories

NON SI VENDE SEPARATAMENTE.

Il Diffusore di fascio luminoso misto serve ad uniformare gli effetti distorsivi del fascio luminoso dovuti ai collimatori con lente parabolica, di Fresnel o TIR senza un allargamento significativo.

L'eccezionale design "misto" assicura una migliore uniformità del campo lontano e una miscelazione cromatica con una straordinaria luminosità assiale. Rispetto ai diffusori tradizionali, mantiene una maggiore intensità luminosa in candele al centro del fascio (CBCP) e diminuisce la sgradevole "luce a lunga gittata" negli angoli più ampi.



	PRODUCT
Model	Anti-glare Honeycomb Louver
Reference	08060000WT
Colour	WT □ Textured white
Category	Accessories

NON SI VENDE SEPARATAMENTE.



Accessorio formato da una griglia a forma di pannello d'ape per ridurre l'abbagliamento e l'incidenza diretta dei raggi durante la visione.

SURFACE & SUSPENDED

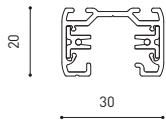
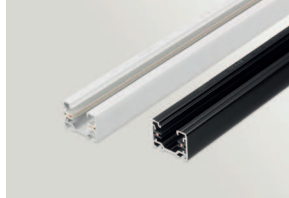

TRACK 1L 1m	A264-01-00- B N
TRACK 1L 2m	A264-02-00- B N
TRACK 1L 3m	A264-03-00- B N



POLARITY GROOVE



	TRACK 1L Live-End Connector
	A264-00-01- B N
	A264-00-02- B N



	TRACK 1L Contact Joint
	A264-00-04- B N

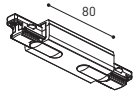

	TRACK 1L Central Connector
	A264-00-03- B N



	TRACK 1L End
	A264-00-13- B N

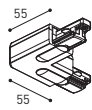

	TRACK 1L 90° Angle
	A264-00-06- B N
	A264-00-07- B N



	TRACK 1L Suspension Kit
	A264-00-14- WT NT
At least 2 units needed	

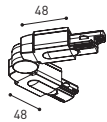

	TRACK 1L Corner connector
	A264-00-15- B N

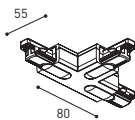

	TRACK 1L T-Joint
	A264-00-16- B N
	A264-00-17- B N

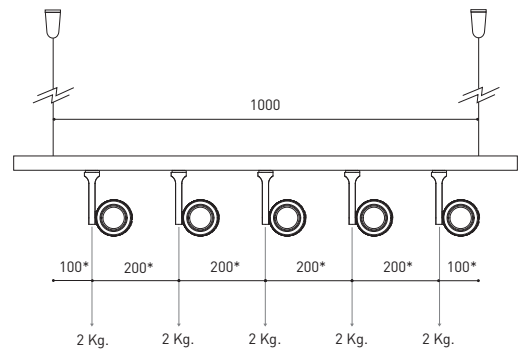

*minimum distance (mm.)

COLOUR | B □ RAL 9016 | N ■ RAL 9005 | WT □ RAL 9016 | NT ■ RAL 9005 |

FLUSH MOUNTING



TRACK 1L FLUSH 1m	A264-11-00- B N
TRACK 1L FLUSH 2m	A264-12-00- B N
TRACK 1L FLUSH 3m	A264-13-00- B N



POLARITY GROOVE



TRACK 1L FLUSH Live-End Connector

A264-00-01- B N
A264-00-02- B N

TRACK 1L FLUSH Cover Plate

A264-10-19- B N

Mandatory for installation



TRACK 1L FLUSH Central Connector

A264-00-03- B N

TRACK 1L FLUSH Corner Cover Plate

A264-10-20- B N

Mandatory for installation



TRACK 1L FLUSH 90° Angle

A264-00-06- B N
A264-00-07- B N

TRACK 1L FLUSH Corner Cover Plate

A264-10-20- B N

Mandatory for installation

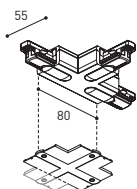

TRACK 1L FLUSH T-Joint

A264-00-16- B N
A264-00-17- B N

TRACK 1L FLUSH Corner Cover Plate

A264-10-20- B N

Mandatory for installation



TRACK 1L Contact Joint

A264-00-04- B N



TRACK 1L End

A264-00-13- B N



TRACK 1L FLUSH Suspension Kit

A264-10-15

For wire 1,5 mm [Not included]



*minimum distance [mm.]

COLOUR | B □ RAL 9016 | N ■ RAL 9005 |



Fuente de luz (LED) reemplazable por un profesional autorizado

Replaceable (LED only) light source by an authorized professional.

Source lumineuse (LED) remplaçable par un professionnel agréé

Sorgente luminosa (LED) sostituibile da parte di un professionista autorizzato

Austauschbare (LED) Lichtquelle durch einen autorisierten Fachmann



Equipo de control reemplazable por un profesional autorizado

Replaceable control gear by an authorized professional

Dispositif de commande remplaçable par un professionnel agréé

Alimentatore sostituibile da parte di un professionista autorizzato

Auswechselbares Betriebsgerät durch autorisierten Fachmann

INSTRUCCIONES PARA EL FINAL DE VIDA Y LA ELIMINACIÓN LOS COMPONENTES
 INSTRUCTIONS ON END-OF-LIFE AND COMPONENT DISPOSAL
 INSTRUCTIONS POUR LA GESTION DES COMPOSANTS EN FIN DE VIE ET LEUR MISE AU REBUT
 ISTRUZIONI PER IL FINE VITA E LO SMALTIMENTO DEI COMPONENTI
 ANWEISUNGEN ZUR ENTSORGUNG DER LEUCHTENKOMPONENTEN



Interrumpir la alimentación del aparato
 Cut the power supply to the luminaire
 Couper l'alimentation du luminaire
 Interrompere l'alimentazione dell'apparecchio
 Stromversorgung der Leuchte unterbrechen



Quitar la(s) fuente(s) de luz para el desecho
 Remove light source(s) for disposal
 Retirer la (les) source(s) lumineuse(s) pour l'élimination
 Rimuovere la/le sorgente/e di luce per lo smaltimento
 Lichtquelle(n) zur Entsorgung entfernen



Quitar la batería para el desecho
 Remove the battery for decommissioning
 Retirer la batterie pour sa mise au rebut
 Rimuovere la batteria per la dismissione
 Die Batterie ordnungsgemäß entsorgen



Quitar el equipo de control para el desecho
 Remove control gear for disposal
 Retirer le dispositif de commande pour l'élimination
 Rimuovere l'alimentatore per lo smaltimento
 Betriebsgerät zur Entsorgung ausbauen



Enviar los materiales a un centro de recogida RAEE
 Send the materials to a WEEE collection centre
 Envoyer les matériaux dans une déchetterie DEEE
 Inviare i materiali ad un centro di raccolta RAEE
 Die Materialien in einem WEEE-Zentrum entsorgen

