

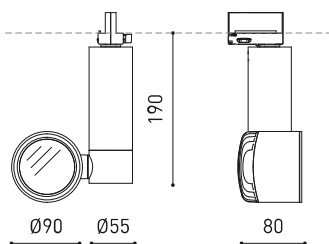

DIMENSIONES



ACCESORIOS



HIGH CHROMATIC LED



ANTI-GLARE HONEYCOMB
LOUVER



ELLIPTICAL REFRACTOR | BEAM
MIXER DIFFUSER



TRACK 3L OPTIONS

PREMIOS



Nombre	ZEN TUBE 1 SPOT 16° 4000K WT
Referencia	A2842112WT
Color	Textured white
RAL	9016
Categoría	TRACKLIGHTS

PRODUCTO

Tipo	LED
Flujo Luminoso	1670 lm
Temperatura de color	4000 K - Other K, please consult
Estabilidad cromática	MacAdam Step 2
Índice de reproducción cromática	CRI > 90
Potencia	12 W
Corriente	350 mA
Eficacia	139 lm/W
Horas de Vida del LED	L90B10 > 55.000h

FUENTE DE LUZ

Eficiencia Lumínica	90%
Ángulo del haz de luz	16°

LUMINARIA | DATOS FOTOMÉTRICOS

Driver	Included
Potencia del sistema	14,00 W
Tensión	220V/240V
Frecuencia	50/60 Hz
Regulación	No Dim
Clase de seguridad eléctrica	<input type="checkbox"/>

LUMINARIA | DATOS ELÉCTRICOS

Estanqueidad	IP20
Control inalámbrico	Please Consult
Ángulo de basculación	270°
Ángulo de giro	355°
Tipo de carril	Track 3L+N
Peso	1000 g
Peso con embalaje	1223,6 g
Dimensiones embalaje	288,5 x 188,5 x 126 mm
Unidades por embalaje	1
Materiales	Aluminium / Glass-Trans

OTROS DATOS



DIAGRAMA POLAR



DIAGRAMA CÓNICO



Vivid Model Colour Temperature	2700K	3000K	3500K	4000K	Light Pink
📖 Reading			•	•	
🥬 Fruits & Vegetables		•	•		
🍩 Bakery	•				
👤 Retail		•	•		
💄 Cosmetics			•	•	
🥩 Meat					•
🐟 Fish				•	
🐠 Seafood				•	•

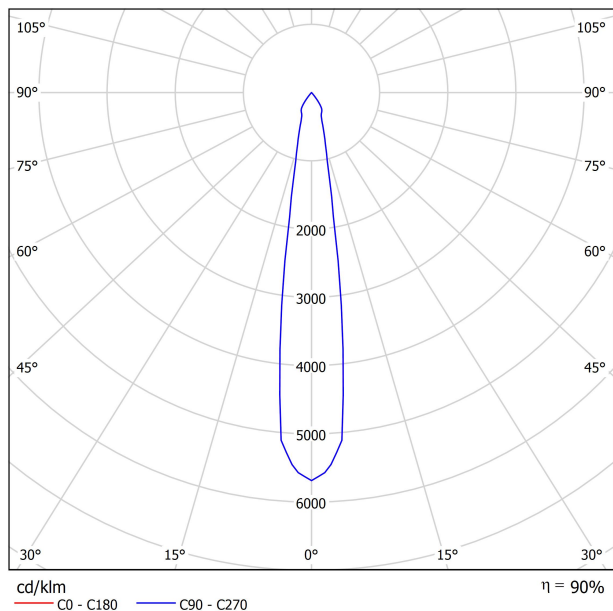
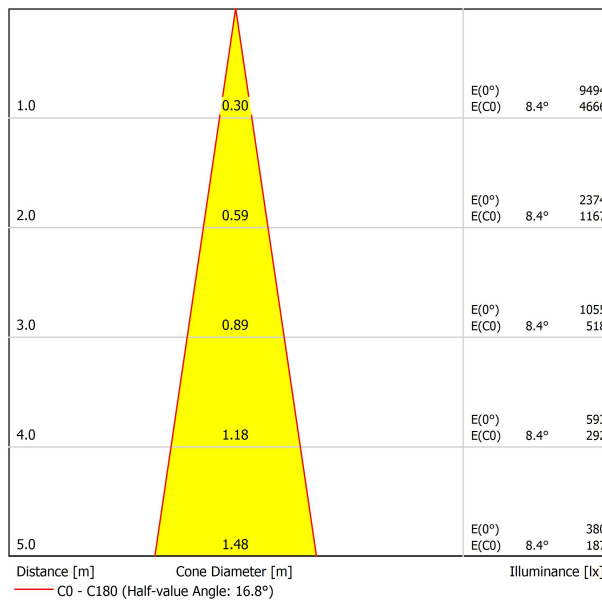

For some of its products, Arkoslight offers the possibility to provide them with a special LED, designed to create an illumination focused on visually promoting goods or products for commercial purposes. It is a high chromaticity LED, capable of identifying the colour shades that produce a positive psychological perception of the illuminated object.

This special LED lighting source offers a much more attractive and intense colour range than a conventional LED, besides being much wider. Technically, this is possible thanks to a special LED setting that includes a «special saturation parameter», capable of highlighting the objects colours and materials in such a way that they seem more attractive within the visible light spectrum. To achieve this performance, in each case, the appropriate diode and specific phosphor coating are carefully selected.



	PRODUCT
Model	Anti-glare Honeycomb Louver
Reference	07020200
Category	Accessories

NOT SOLD SEPARATELY.



Accessory made up of louvers in the shape of a honeycomb panel to reduce glare and the effects of direct rays of vision.



	PRODUCT
Model	Elliptical Refractor
Reference	07000800
Category	Accessories

NOT SOLD SEPARATELY.

Lens that modifies the light beam to achieve an elliptical shape through light refraction in its optical glass.



	PRODUCT
Model	Beam Mixer Diffuser
Reference	08050200
Category	Accessories

NOT SOLD SEPARATELY.

The Beam Mixer Diffuser is used to smooth beam artifacts caused by parabolic, Fresnel, or TIR lens collimators without significant broadening.

The unique mixing design provides superior far-field smoothing and color mixing with high on-axis brightness. Compared with traditional diffusers, it maintains higher central beam candlepower (CBCP), and produce less undesirable "field light" at higher angles.

TRACK 3L+N SURFACE & SUSPENDED

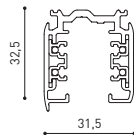

TRACK 3L 1m	A282-01-00- B N
TRACK 3L 2m	A282-02-00- B N
TRACK 3L 3m	A282-03-00- B N



TRACK 3L+N FLUSH MOUNTING*

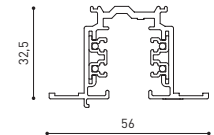

TRACK 3L FLUSH 1m	A282-11-00- B N
TRACK 3L FLUSH 2m	A282-12-00- B N
TRACK 3L FLUSH 3m	A282-13-00- B N



WEIGHT BEAR CAPACITY

Distancia de fijación y capacidad de carga.
Distancia fijación recomendada l- 1000 mm.

Fastening distance and loading capacity.
Recommended fastening distance l- 1000 mm.

Distance de fixation et capacité de charge.
Distance de fixation recommandée l- 1000 mm.

Distanza di installazione e capacità di carico.
Distanza consigliata di fissazione l- 1000 mm.

Befestigungsabstand und Belastbarkeit.
Empfohlener Abstand l- 1000 mm.

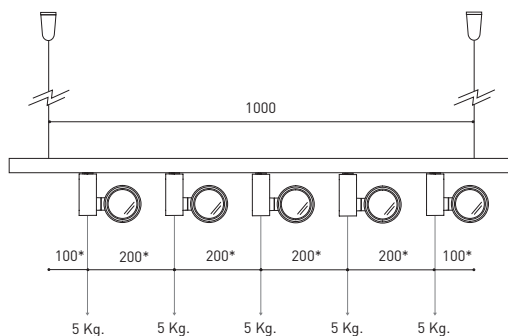

*minimum distance (mm.)

ACCESSORIES

FIT MODEL: ACCESSORIES ONLY IN BLACK FINISH
SIX MODEL: ACCESSORIES NOT AVAILABLE

TRACKLIGHT Surface Adapter

0000-55-43-	W
0000-55-39-	N

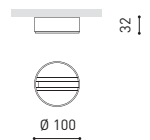

TRACKLIGHT Recessed Adapter

0000-55-44-	W
0000-55-40-	N

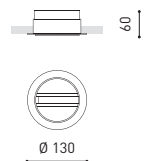

COLOUR | B □ RAL 9016 | N ■ RAL 9005 |

SURFACE & SUSPENDED

FLUSH MOUNTING

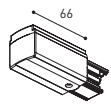

POLARITY GROOVE



TRACK 3L Live-End Connector

A282-00-01- | B | N |

A282-00-02- | B | N |

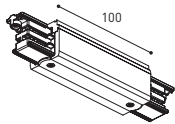

TRACK 3L Central Connector

A282-00-03- | B | N |



TRACK 3L Ceiling Kit

A219-21-06- | B | N |

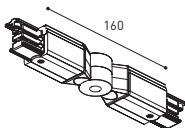

TRACK 3L Universal Angle

A282-00-15- | B | N |

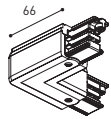

TRACK 3L 90° Angle

A282-00-06- | B | N |

A282-00-07- | B | N |

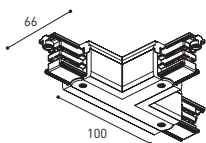

TRACK 3L T Joint

A282-00-16- | B | N |

A282-00-17- | B | N |

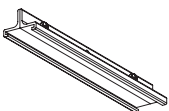

TRACK 3L Mechanical Joint

A219-21-11- | B | N |



TRACK 3L Suspension Kit

A219-21-10- | B | N |

At least 2 units needed

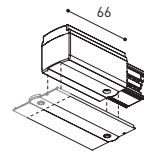

POLARITY GROOVE



TRACK 3L Live-End Connector

A282-00-01- | B | N |

A282-00-02- | B | N |

TRACK 3L FLUSH Cover Plate

A282-10-19- | B | N |

Mandatory for installation

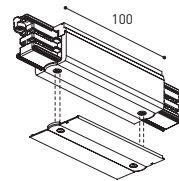

TRACK 3L Central Connector

A282-00-03- | B | N |

TRACK 3L FLUSH Cover Plate

A282-10-19- | B | N |

Mandatory for installation



TRACK 3L FLUSH Ceiling Kit

A219-22-06- | B |

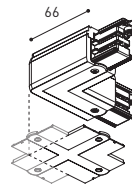

TRACK 3L 90° Angle

A282-00-06- | B | N |

A282-00-07- | B | N |



TRACK 3L FLUSH Corner Cover Plate

A282-10-20- | B | N |

Mandatory for installation

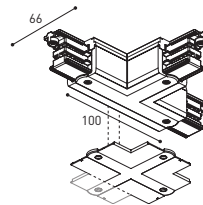

TRACK 3L T Joint

A282-00-16- | B | N |

A282-00-17- | B | N |



TRACK 3L FLUSH Corner Cover Plate

A282-10-20- | B | N |

Mandatory for installation

SURFACE & SUSP. / FLUSH MOUNTING

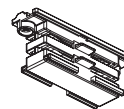

TRACK Contact Joint

A282-00-04- | B | N |



TRACK End

A219-20-02- | B | N |



TRACK Clamp Kit for M6 ROD

A219-21-21- | B |

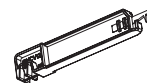

TRACK Bending Tool

A282-00-00

For tracks its length has been modified

COLOUR | B □ RAL 9016 | N ■ RAL 9005 |



Fuente de luz (LED) reemplazable por un profesional autorizado

Replaceable (LED only) light source by an authorized professional.

Source lumineuse (LED) remplaçable par un professionnel agréé

Sorgente luminosa (LED) sostituibile da parte di un professionista autorizzato

Austauschbare (LED) Lichtquelle durch einen autorisierten Fachmann



Equipo de control reemplazable por un profesional autorizado

Replaceable control gear by an authorized professional

Dispositif de commande remplaçable par un professionnel agréé

Alimentatore sostituibile da parte di un professionista autorizzato

Auswechselbares Betriebsgerät durch autorisierten Fachmann

INSTRUCCIONES PARA EL FINAL DE VIDA Y LA ELIMINACIÓN LOS COMPONENTES
 INSTRUCTIONS ON END-OF-LIFE AND COMPONENT DISPOSAL
 INSTRUCTIONS POUR LA GESTION DES COMPOSANTS EN FIN DE VIE ET LEUR MISE AU REBUT
 ISTRUZIONI PER IL FINE VITA E LO SMALTIMENTO DEI COMPONENTI
 ANWEISUNGEN ZUR ENTSORGUNG DER LEUCHTENKOMPONENTEN



Interrumpir la alimentación del aparato
 Cut the power supply to the luminaire
 Couper l'alimentation du luminaire
 Interrompere l'alimentazione dell'apparecchio
 Stromversorgung der Leuchte unterbrechen



Quitar la(s) fuente(s) de luz para el desecho
 Remove light source(s) for disposal
 Retirer la (les) source(s) lumineuse(s) pour l'élimination
 Rimuovere la/le sorgente/e di luce per lo smaltimento
 Lichtquelle(n) zur Entsorgung entfernen



Quitar la batería para el desecho
 Remove the battery for decommissioning
 Retirer la batterie pour sa mise au rebut
 Rimuovere la batteria per la dismissione
 Die Batterie ordnungsgemäß entsorgen



Quitar el equipo de control para el desecho
 Remove control gear for disposal
 Retirer le dispositif de commande pour l'élimination
 Rimuovere l'alimentatore per lo smaltimento
 Betriebsgerät zur Entsorgung ausbauen



Enviar los materiales a un centro de recogida RAEE
 Send the materials to a WEEE collection centre
 Envoyer les matériaux dans une déchetterie DEEE
 Inviare i materiali ad un centro di raccolta RAEE
 Die Materialien in einem WEEE-Zentrum entsorgen

