

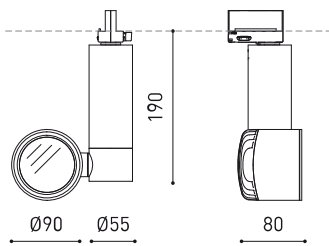

DIMENSIONS



ACCESSORIES



HIGH CHROMATIC LED



ANTI-GLARE HONEYCOMB LOUVER



ELLIPTICAL REFRACTOR | BEAM MIXER DIFFUSER



TRACK 3L OPTIONS

AWARDS



Name	ZEN TUBE 2 FLOOD 42° 3000K NT
Reference	A2842231NT
Color	Textured black
RAL	9005
Category	TRACK LIGHTS

PRODUCT

Type	LED
Gross luminous flux	2220 lm
Colour temperature	3000 K - Other K, please consult
Chromatic stability	MacAdam Step 2
Colour Rendering Index	CRI>90
Power	17 W
Current	500 mA
Efficacy	131 lm/W
LED lifespan	L90B10 >55.000h

LIGHT SOURCE

Lighting efficiency	90%
Light beam angle	42°

LIGHTING FIXTURE | PHOTOMETRIC DATA

Driver	Included
Power values of the system	19,80 W
Frequency	50/60 Hz
Dimming	No Dim
Electrical insulation class	□

LIGHTING FIXTURE | ELECTRICAL DATA

Sealing	IP20
Wireless control	Please Consult
Swivel angle	270°
Rotation angle	355°
Track type	Track 3L+N
Weight	1000 g
Packaged weight	1223,6 g
Packaging dimensions	288.5 x 188.5 x 126 mm
Units per package	1
Materials	Aluminium / Glass-Trans

OTHER DATA



Make your space stand out with a design piece, its chrome details and attractive texturized finish.



POLAR DIAGRAM



CONICAL DIAGRAM

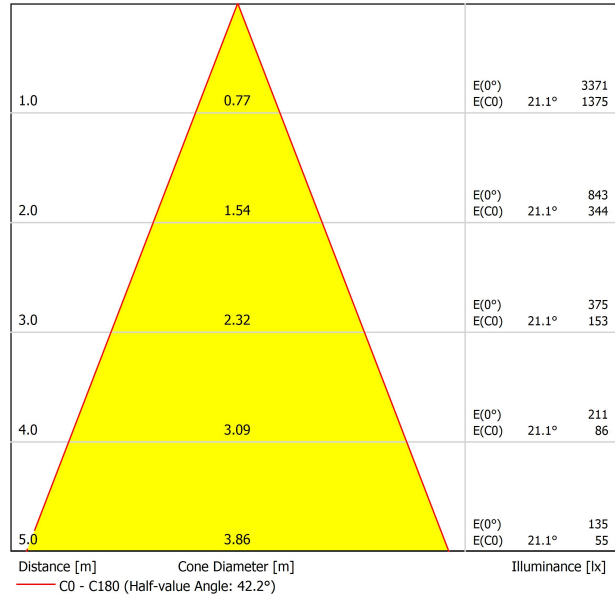

Vivid Model Colour Temperature	2700K	3000K	3500K	4000K	Light Pink
📖 Reading			•	•	
🥬 Fruits & Vegetables		•	•		
🍞 Bakery	•				
👤 Retail		•	•		
💄 Cosmetics			•	•	
🥩 Meat					•
🐟 Fish				•	
🐠 Seafood				•	•



For some of its products, Arkoslight offers the possibility to provide them with a special LED, designed to create an illumination focused on visually promoting goods or products for commercial purposes. It is a high chromaticity LED, capable of identifying the colour shades that produce a positive psychological perception of the illuminated object.

This special LED lighting source offers a much more attractive and intense colour range than a conventional LED, besides being much wider. Technically, this is possible thanks to a special LED setting that includes a «special saturation parameter», capable of highlighting the objects colours and materials in such a way that they seem more attractive within the visible light spectrum. To achieve this performance, in each case, the appropriate diode and specific phosphor coating are carefully selected.



	PRODUCT
Model	Anti-glare Honeycomb Louver
Reference	07020200
Category	Accessories

NOT SOLD SEPARATELY.



Accessory made up of louver in the shape of a honeycomb panel to reduce glare and the effects of direct rays of vision.



	PRODUCT
Model	Elliptical Refractor
Reference	07000800
Category	Accessories

NOT SOLD SEPARATELY.

Lens that modifies the light beam to achieve an elliptical shape through light refraction in its optical glass.



	PRODUCT
Model	Beam Mixer Diffuser
Reference	08050200
Category	Accessories

NOT SOLD SEPARATELY.

The Beam Mixer Diffuser is used to smooth beam artifacts caused by parabolic, Fresnel, or TIR lens collimators without significant broadening.

The unique mixing design provides superior far-field smoothing and color mixing with high on-axis brightness. Compared with traditional diffusers, it maintains higher central beam candlepower (CBCP), and produce less undesirable "field light" at higher angles.

## TRACK 3L+N SURFACE & SUSPENDED

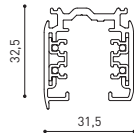

TRACK 3L 1m	A282-01-00-   B   N
TRACK 3L 2m	A282-02-00-   B   N
TRACK 3L 3m	A282-03-00-   B   N



## TRACK 3L+N FLUSH MOUNTING\*

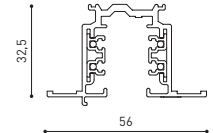
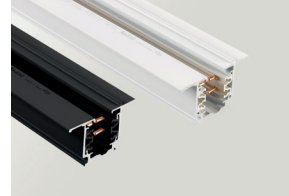

TRACK 3L FLUSH 1m	A282-11-00-   B   N
TRACK 3L FLUSH 2m	A282-12-00-   B   N
TRACK 3L FLUSH 3m	A282-13-00-   B   N



## WEIGHT BEAR CAPACITY

Distancia de fijación y capacidad de carga.  
Distancia fijación recomendada l- 1000 mm.

Fastening distance and loading capacity.  
Recommended fastening distance l- 1000 mm.

Distance de fixation et capacité de charge.  
Distance de fixation recommandée l- 1000 mm.

Distanza di installazione e capacità di carico.  
Distanza consigliata di fissazione l- 1000 mm.

Befestigungsabstand und Belastbarkeit.  
Empfohlener Abstand l- 1000 mm.

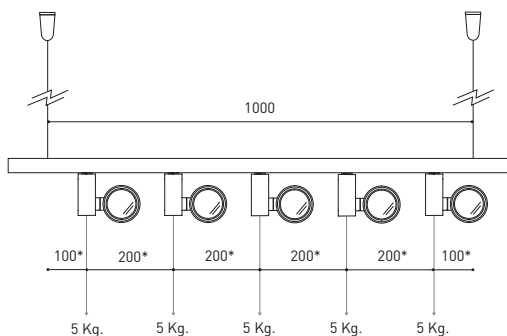

\*minimum distance (mm.)

## ACCESSORIES

FIT MODEL: ACCESSORIES ONLY IN BLACK FINISH  
SIX MODEL: ACCESSORIES NOT AVAILABLE

### TRACKLIGHT Surface Adapter

0000-55-43- | W |

0000-55-39- | N |



### TRACKLIGHT Recessed Adapter

0000-55-44- | W |

0000-55-40- | N |



COLOUR | B □ RAL 9016 | N ■ RAL 9005 |

## SURFACE & SUSPENDED

## FLUSH MOUNTING



POLARITY GROOVE



### TRACK 3L Live-End Connector

A282-00-01- | B | N |

A282-00-02- | B | N |



### TRACK 3L Central Connector

A282-00-03- | B | N |



### TRACK 3L Ceiling Kit

A219-21-06- | B | N |



### TRACK 3L Universal Angle

A282-00-15- | B | N |



### TRACK 3L 90° Angle

A282-00-06- | B | N |

A282-00-07- | B | N |



### TRACK 3L T Joint

A282-00-16- | B | N |

A282-00-17- | B | N |



### TRACK 3L Mechanical Joint

A219-21-11- | B | N |



### TRACK 3L Suspension Kit

A219-21-10- | B | N |

At least 2 units needed

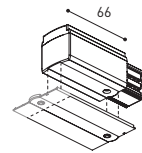

POLARITY GROOVE



### TRACK 3L Live-End Connector

A282-00-01- | B | N |

A282-00-02- | B | N |

### TRACK 3L FLUSH Cover Plate

A282-10-19- | B | N |

Mandatory for installation

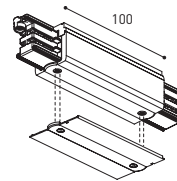

### TRACK 3L Central Connector

A282-00-03- | B | N |

### TRACK 3L FLUSH Cover Plate

A282-10-19- | B | N |

Mandatory for installation



### TRACK 3L FLUSH Ceiling Kit

A219-22-06- | B |

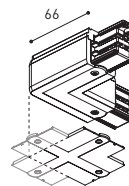

### TRACK 3L 90° Angle

A282-00-06- | B | N |

A282-00-07- | B | N |

### TRACK 3L FLUSH Corner Cover Plate

A282-10-20- | B | N |

Mandatory for installation

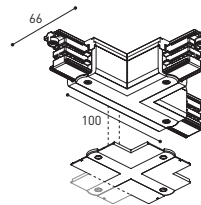

### TRACK 3L T Joint

A282-00-16- | B | N |

A282-00-17- | B | N |

### TRACK 3L FLUSH Corner Cover Plate

A282-10-20- | B | N |

Mandatory for installation

## SURFACE & SUSP. / FLUSH MOUNTING

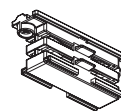

### TRACK Contact Joint

A282-00-04- | B | N |



### TRACK End

A219-20-02- | B | N |



### TRACK Clamp Kit for M6 ROD

A219-21-21- | B |

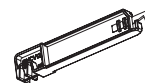

### TRACK Bending Tool

A282-00-00

For tracks its length has been modified

COLOUR | B □ RAL 9016 | N ■ RAL 9005 |





Fuente de luz (LED) reemplazable por un profesional autorizado  
 Replaceable (LED only) light source by an authorized professional.  
 Source lumineuse (LED) remplaçable par un professionnel agréé  
 Sorgente luminosa (LED) sostituibile da parte di un professionista autorizzato  
 Austauschbare (LED) Lichtquelle durch einen autorisierten Fachmann



Equipo de control reemplazable por un profesional autorizado  
 Replaceable control gear by an authorized professional  
 Dispositif de commande remplaçable par un professionnel agréé  
 Alimentatore sostituibile da parte di un professionista autorizzato  
 Auswechselbares Betriebsgerät durch autorisierten Fachmann

INSTRUCCIONES PARA EL FINAL DE VIDA Y LA ELIMINACIÓN LOS COMPONENTES  
 INSTRUCTIONS ON END-OF-LIFE AND COMPONENT DISPOSAL  
 INSTRUCTIONS POUR LA GESTION DES COMPOSANTS EN FIN DE VIE ET LEUR MISE AU REBUT  
 ISTRUZIONI PER IL FINE VITA E LO SMALTIMENTO DEI COMPONENTI  
 ANWEISUNGEN ZUR ENTSORGUNG DER LEUCHTENKOMPONENTEN



Interrumpir la alimentación del aparato  
 Cut the power supply to the luminaire  
 Couper l'alimentation du luminaire  
 Interrompere l'alimentazione dell'apparecchio  
 Stromversorgung der Leuchte unterbrechen



Quitar la(s) fuente(s) de luz para el desecho  
 Remove light source(s) for disposal  
 Retirer la (les) source(s) lumineuse(s) pour l'élimination  
 Rimuovere la/le sorgente/e di luce per lo smaltimento  
 Lichtquelle(n) zur Entsorgung entfernen



Quitar la batería para el desecho  
 Remove the battery for decommissioning  
 Retirer la batterie pour sa mise au rebut  
 Rimuovere la batteria per la dismissione  
 Die Batterie ordnungsgemäß entsorgen



Quitar el equipo de control para el desecho  
 Remove control gear for disposal  
 Retirer le dispositif de commande pour l'élimination  
 Rimuovere l'alimentatore per lo smaltimento  
 Betriebsgerät zur Entsorgung ausbauen

Enviar los materiales a un centro de recogida RAEE  
 Send the materials to a WEEE collection centre  
 Envoyer les matériaux dans une déchetterie DEEE  
 Inviare i materiali ad un centro di raccolta RAEE  
 Die Materialien in einem WEEE-Zentrum entsorgen

