

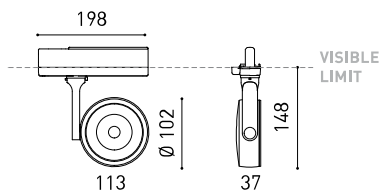

DIMENSIONS



ACCESSOIRES



HIGH CHROMATIC LED



TRACK 3L OPTIONS

PRIX



PRODUIT

Nom	SIX L 2 DIM DALI 17° 3000K NT
Référence	A2862411NT
Couleur	Noir Texturé
RAL	9005
Catégorie	TRACK LIGHTS

SOURCE DE LUMIÈRE

Type	LED
Flux lumineux brut	2950 lm
Température de couleur	3000 K
Stabilité chromatique	MacAdam Step 2
Indice de reproduction chromatique	CRI > 90
Puissance	24,5 W
Courant	700 mA
Efficacité	120 lm/W
Durée de vie de la LED	L90B10 > 55.000h

LUMINAIRE | DONNÉS PHOTOMÉTRIQUES

Efficacité lumineuse	93%
Angle du faisceau lumineux	17°

LUMINAIRE | DONNÉS ÉLECTRIQUES

Driver	Inclus
Valeurs de puissance du système	28,15 W
Tension	220V/240V
Fréquence	50/60 Hz
Variation d'intensité	DALI
Classe d'isolation électrique	□

D'AUTRES DONNÉES

Étanchéité	IP20
Contrôle sans fil	Veuillez consulter
Angle d'inclinaison	310°
Angle de rotation	350°
Type de rail	Track 3L+N Dimmable
Poids	660 g
Poids avec emballage	785 g
Dimensions de l'emballage	309 x 195 x 62 mm
Unités par emballage	1
Matériaux	Aluminium / Polycarbonate



Six est un projecteur pour applications de rail ou encastrement isolé qui se caractérise par sa légèreté et élégance. Son corps est présenté en forme de disque, légèrement arrondi, qui contient une combinaison innovante de réflecteur et lentille. L'action conjointe des deux permet diriger le faisceau de lumière avec un maximum d'uniformité dans une distance minimum ce qui a permis son design différencié - réduit et minimaliste. La gamme de projecteurs Six est disponible depuis la taille XS jusqu'à la taille XL, avec des versions pour rails de basse et haute tension, des versions encastrables et des versions 'doubles', qui sont composées de deux éléments contigus.

DIAGRAMME POLAIRE



DIAGRAMME CONIQUE

1.0	0.28 0.28	E(0°) 22050 E(C90) 7.9° 10862 E(C0) 8.0° 10745
2.0	0.56 0.56	E(0°) 5513 E(C90) 7.9° 2716 E(C0) 8.0° 2686
3.0	0.83 0.84	E(0°) 2450 E(C90) 7.9° 1207 E(C0) 8.0° 1194
4.0	1.11 1.12	E(0°) 1378 E(C90) 7.9° 679 E(C0) 8.0° 672
5.0	1.39 1.41	E(0°) 882 E(C90) 7.9° 434 E(C0) 8.0° 430
Distance [m]	Cone Diameter [m]	Illuminance [lx]
— C0 - C180 (Half-value Angle: 16.0°)		
— C90 - C270 (Half-value Angle: 15.8°)		

POUR PRÉSENTATION COMMERCIALE DU PRODUIT

Vivid Model Colour Temperature	2700K	3000K	3500K	4000K	Light Pink
📖 Reading			•	•	
🥬 Fruits & Vegetables		•	•		
🍞 Bakery	•				
👤 Retail		•	•		
💄 Cosmetics			•	•	
🥩 Meat					•
🐟 Fish				•	
🐠 Seafood				•	•

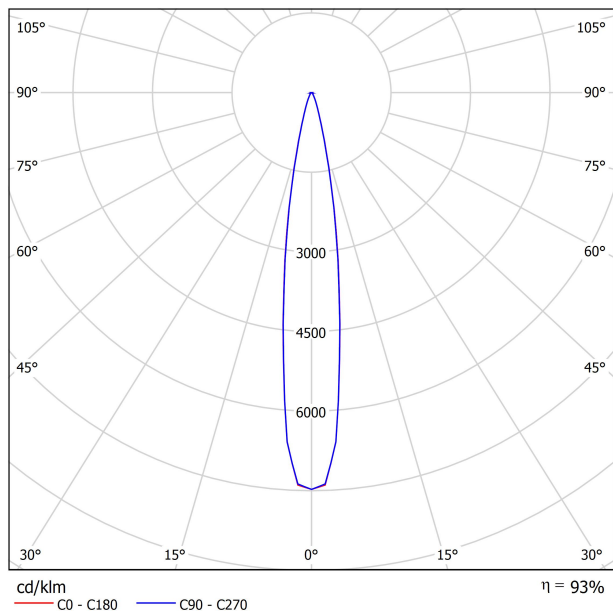

Arkoslight vous offre sur certains de ses produits la possibilité de les équiper d'un LED spécial, qui a été conçu pour une illumination orientée à la promotion visuelle de biens ou produits à des fins commerciales.

Il s'agit d'un LED de haute chromaticité permettant de mettre en évidence les tons qui favorisent une perception psychologique positive de l'objet illuminé.

Cette source de lumière LED spéciale vous offre une palette de couleurs plus attractive et intense, et plus vaste que celle d'un LED conventionnel. Ceci est possible grâce à la configuration du LED qui inclue un "paramètre spécial de saturation", lequel réussit à ce que les couleurs et la texture des objets apparaissent de manière plus attractive dans le spectre de lumière visible. Pour ce faire, le diode correspondant est sélectionné en fonction de chaque cas, et il en est de même pour son revêtement spécifique en phosphore.

TRACK 3L+N SURFACE & SUSPENDED



TRACK 3L 1M	A219-21-01-	B	N
TRACK 3L 2M	A219-21-02-	B	N
TRACK 3L 3M	A219-21-03-	B	N



TRACK 3L+N FLUSH MOUNTING



TRACK 3L FLUSH 1M	A219-22-01-	B	N
TRACK 3L FLUSH 2M	A219-22-02-	B	N
TRACK 3L FLUSH 3M	A219-22-03-	B	N

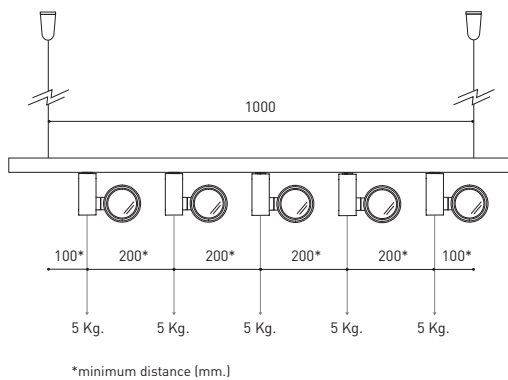

WEIGHT BEAR CAPACITY

Distancia de fijación y capacidad de carga.
Distancia de fijación recomendada l- 1000mm.

Fastening distance and loading capacity.
Recommended fastening distance l- 1000mm.

Distance de fixation et capacité de charge.
Distance de fixation recommandée l- 1000mm.

Distanza di installazione e capacità di carico.
Distanza consigliata di fissazione l- 1000mm.

Befestigungsabstand und Belastbarkeit.
Empfohlener Abstand l- 1000mm.

COLOUR | B □ RAL 9016 | N ■ RAL 9005 |

Calle N · Pol. Ind. EL OLIVERAL
46394 Ribarroja del Turia · Valencia (Spain)
Tel. +34 961 667 207 · Fax +34 961 667 054
info@arkoslight.com · www.arkoslight.com



SURFACE & SUSPENDED



POLARITY GROOVE



TRACK 3L Live-End Connector

A219-21-04- | B | N |

A219-21-12- | B | N |



TRACK 3L Central Connector

A219-21-05- | B | N |



TRACK 3L Ceiling Kit

A219-21-06- | B | N |



TRACK 3L Universal Angle

A219-21-07- | B | N |

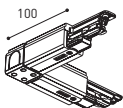

TRACK 3L 90° Angle

A219-21-08- | B | N |

A219-21-13- | B | N |

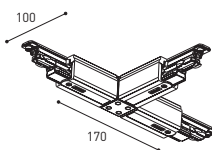

TRACK 3L T Joint

A219-21-09- | B | N |

A219-21-14- | B | N |

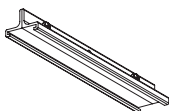

TRACK 3L Mechanical Joint

A219-21-11- | B | N |



TRACK 3L Suspension Kit

A219-21-10- | B | N |

At least 2 units needed

FLUSH MOUNTING

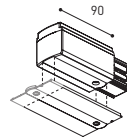

POLARITY GROOVE



TRACK 3L Live-End Connector

A219-21-04- | B | N |

A219-21-12- | B | N |

TRACK 3L FLUSH Cover Plate

A219-22-10- | B | N |

Mandatory for installation

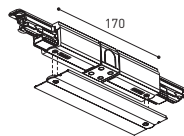

TRACK 3L Central Connector

A219-21-05- | B | N |

TRACK 3L FLUSH Cover Plate

A219-22-10- | B | N |

Mandatory for installation



TRACK 3L FLUSH Ceiling Kit

A219-22-06- | B |

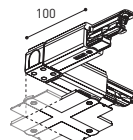

TRACK 3L 90° Angle

A219-21-08- | B | N |

A219-21-13- | B | N |

TRACK 3L FLUSH Corner Cover Plate

A219-22-11- | B | N |

Mandatory for installation

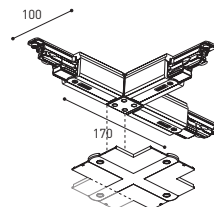

TRACK 3L T Joint

A219-21-09- | B | N |

A219-21-14- | B | N |

TRACK 3L FLUSH Corner Cover Plate

A219-22-11- | B | N |

Mandatory for installation

SURFACE & SUSP. / FLUSH MOUNTING

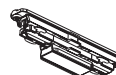

TRACK Contact Joint

A219-20-01- | B | N |



TRACK End

A219-20-02- | B | N |



TRACK Clamp Kit for M6 ROD

A219-21-21- | B |

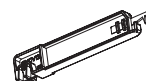

TRACK Bending Tool

A282-00-00

For tracks its length has been modified

COLOUR | B □ RAL 9016 | N ■ RAL 9005 |



Fuente de luz (LED) reemplazable por un profesional autorizado

Replaceable (LED only) light source by an authorized professional.

Source lumineuse (LED) remplaçable par un professionnel agréé

Sorgente luminosa (LED) sostituibile da parte di un professionista autorizzato

Austauschbare (LED) Lichtquelle durch einen autorisierten Fachmann



Equipo de control reemplazable por un profesional autorizado

Replaceable control gear by an authorized professional

Dispositif de commande remplaçable par un professionnel agréé

Alimentatore sostituibile da parte di un professionista autorizzato

Auswechselbares Betriebsgerät durch autorisierten Fachmann

INSTRUCCIONES PARA EL FINAL DE VIDA Y LA ELIMINACIÓN LOS COMPONENTES
 INSTRUCTIONS ON END-OF-LIFE AND COMPONENT DISPOSAL
 INSTRUCTIONS POUR LA GESTION DES COMPOSANTS EN FIN DE VIE ET LEUR MISE AU REBUT
 ISTRUZIONI PER IL FINE VITA E LO SMALTIMENTO DEI COMPONENTI
 ANWEISUNGEN ZUR ENTSORGUNG DER LEUCHTENKOMPONENTEN



Interrumpir la alimentación del aparato
 Cut the power supply to the luminaire
 Couper l'alimentation du luminaire
 Interrompere l'alimentazione dell'apparecchio
 Stromversorgung der Leuchte unterbrechen



Quitar la(s) fuente(s) de luz para el desecho
 Remove light source(s) for disposal
 Retirer la (les) source(s) lumineuse(s) pour l'élimination
 Rimuovere la/le sorgente/e di luce per lo smaltimento
 Lichtquelle(n) zur Entsorgung entfernen



Quitar la batería para el desecho
 Remove the battery for decommissioning
 Retirer la batterie pour sa mise au rebut
 Rimuovere la batteria per la dismissione
 Die Batterie ordnungsgemäß entsorgen



Quitar el equipo de control para el desecho
 Remove control gear for disposal
 Retirer le dispositif de commande pour l'élimination
 Rimuovere l'alimentatore per lo smaltimento
 Betriebsgerät zur Entsorgung ausbauen



Enviar los materiales a un centro de recogida RAEE
 Send the materials to a WEEE collection centre
 Envoyer les matériaux dans une déchetterie DEEE
 Inviare i materiali ad un centro di raccolta RAEE
 Die Materialien in einem WEEE-Zentrum entsorgen

