

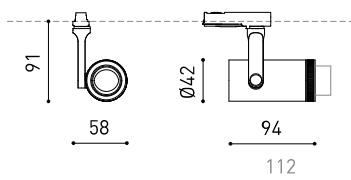

DIMENSIONS



ACCESSORIES



HIGH CHROMATIC LED



TRACK 1L OPTIONS

AWARDS



| | |
|-----------|-----------------------|
| Name | PLUS MINI 1L 2700K NT |
| Reference | A3270020NT |
| Color | Textured black |
| RAL | 9005 |
| Category | TRACK LIGHTS |

LIGHT SOURCE

| | |
|------------------------|------------------|
| Type | LED |
| Gross luminous flux | 480 lm |
| Colour temperature | 2700 K |
| Chromatic stability | MacAdam Step 2 |
| Colour Rendering Index | CRI > 90 |
| Power | 4,5 W |
| Current | 500 mA |
| Efficacy | 107 lm/W |
| LED lifespan | L90B10 > 55.000h |

LIGHTING FIXTURE | PHOTOMETRIC DATA

| | |
|---------------------|---------|
| Lighting efficiency | 20-40% |
| Light beam angle | 10°-41° |

LIGHTING FIXTURE | ELECTRICAL DATA

| | |
|-----------------------------|----------|
| Driver | Included |
| Power values of the system | 5,80 W |
| Frequency | 50/60 Hz |
| Dimming | No Dim |
| Electrical insulation class | ⊕ |

OTHER DATA

| | |
|----------------------|---|
| Sealing | IP20 |
| Swivel angle | 180° |
| Rotation angle | 350° |
| Track type | Track 1L |
| Weight | 237 g |
| Packaged weight | 320 g |
| Packaging dimensions | 199 x 162 x 63 mm |
| Units per package | 1 |
| Materials | Aluminium / Optical Polymethyl Methacrylate |



Plus Mini 1L is a miniaturised spotlight for monophasic track applications which offers the possibility of expanding or concentrating the beam light with just a smooth manual gesture. This characteristic makes Plus the ideal alternative for applications where the precision within the beam of light is essential- like for example: museums, exhibitions, retail or accent lighting applications.

POLAR DIAGRAM



cd/klm
 — C0 - C180 — C90 - C270

CONICAL DIAGRAM

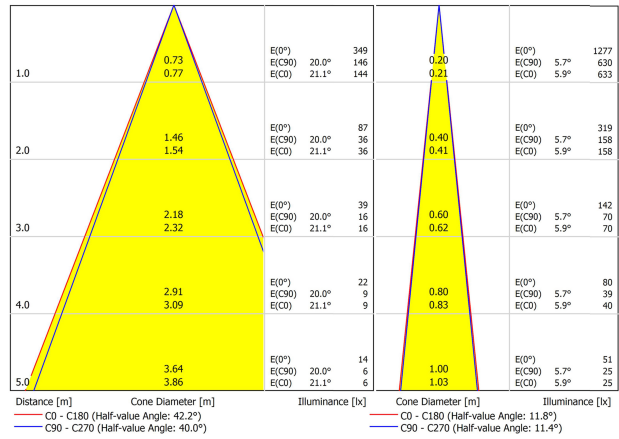

| Vivid Model Colour Temperature | 2700K | 3000K | 3500K | 4000K | Light Pink |
|-----------------------------------|-------|-------|-------|-------|------------|
| 📖 Reading | | | • | • | |
| 🥬 Fruits & Vegetables | | • | • | | |
| 🍞 Bakery | • | | | | |
| 👤 Retail | | • | • | | |
| 💄 Cosmetics | | | • | • | |
| 🥩 Meat | | | | | • |
| 🐟 Fish | | | | • | |
| 🐠 Seafood | | | | • | • |



For some of its products, Arkoslight offers the possibility to provide them with a special LED, designed to create an illumination focused on visually promoting goods or products for commercial purposes. It is a high chromaticity LED, capable of identifying the colour shades that produce a positive psychological perception of the illuminated object.

This special LED lighting source offers a much more attractive and intense colour range than a conventional LED, besides being much wider. Technically, this is possible thanks to a special LED setting that includes a «special saturation parameter», capable of highlighting the objects colours and materials in such a way that they seem more attractive within the visible light spectrum. To achieve this performance, in each case, the appropriate diode and specific phosphor coating are carefully selected.

SURFACE & SUSPENDED



| | |
|-------------|---------------------|
| TRACK 1L 1m | A264-01-00- B N |
| TRACK 1L 2m | A264-02-00- B N |
| TRACK 1L 3m | A264-03-00- B N |



POLARITY GROOVE



| | |
|--|------------------------------------|
| | TRACK 1L Live-End Connector |
| | A264-00-01- B N |
| | A264-00-02- B N |

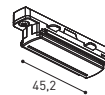

| | |
|--|-------------------------------|
| | TRACK 1L Contact Joint |
| | A264-00-04- B N |

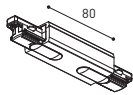

| | |
|--|-----------------------------------|
| | TRACK 1L Central Connector |
| | A264-00-03- B N |



| | |
|--|---------------------|
| | TRACK 1L End |
| | A264-00-13- B N |

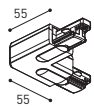

| | |
|--|---------------------------|
| | TRACK 1L 90° Angle |
| | A264-00-06- B N |
| | A264-00-07- B N |

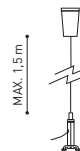

| | |
|--|--------------------------------|
| | TRACK 1L Suspension Kit |
| | A264-00-14- WT NT |
| <small>At least 2 units needed</small> | |

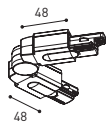

| | |
|--|----------------------------------|
| | TRACK 1L Corner connector |
| | A264-00-15- B N |

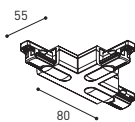

| | |
|--|-------------------------|
| | TRACK 1L T-Joint |
| | A264-00-16- B N |
| | A264-00-17- B N |

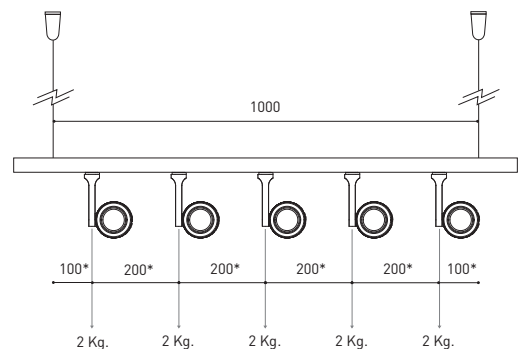

*minimum distance (mm.)

COLOUR | B □ RAL 9016 | N ■ RAL 9005 | WT □ RAL 9016 | NT ■ RAL 9005 |

FLUSH MOUNTING



| | |
|-------------------|---------------------|
| TRACK 1L FLUSH 1m | A264-11-00- B N |
| TRACK 1L FLUSH 2m | A264-12-00- B N |
| TRACK 1L FLUSH 3m | A264-13-00- B N |



POLARITY GROOVE

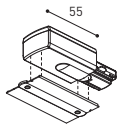

TRACK 1L FLUSH Live-End Connector

| |
|---------------------|
| A264-00-01- B N |
| A264-00-02- B N |

TRACK 1L FLUSH Cover Plate

| |
|---------------------|
| A264-10-19- B N |
|---------------------|

Mandatory for installation



TRACK 1L FLUSH Central Connector

| |
|---------------------|
| A264-00-03- B N |
|---------------------|

TRACK 1L FLUSH Corner Cover Plate

| |
|---------------------|
| A264-10-20- B N |
|---------------------|

Mandatory for installation

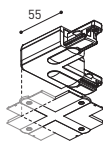

TRACK 1L FLUSH 90° Angle

| |
|---------------------|
| A264-00-06- B N |
| A264-00-07- B N |

TRACK 1L FLUSH Corner Cover Plate

| |
|---------------------|
| A264-10-20- B N |
|---------------------|

Mandatory for installation

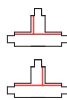
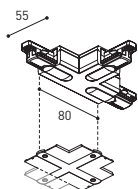

TRACK 1L FLUSH T-Joint

| |
|---------------------|
| A264-00-16- B N |
| A264-00-17- B N |

TRACK 1L FLUSH Corner Cover Plate

| |
|---------------------|
| A264-10-20- B N |
|---------------------|

Mandatory for installation



TRACK 1L Contact Joint

| |
|---------------------|
| A264-00-04- B N |
|---------------------|



TRACK 1L End

| |
|---------------------|
| A264-00-13- B N |
|---------------------|



TRACK 1L FLUSH Suspension Kit

| |
|------------|
| A264-10-15 |
|------------|

For wire 1,5 mm [Not included]

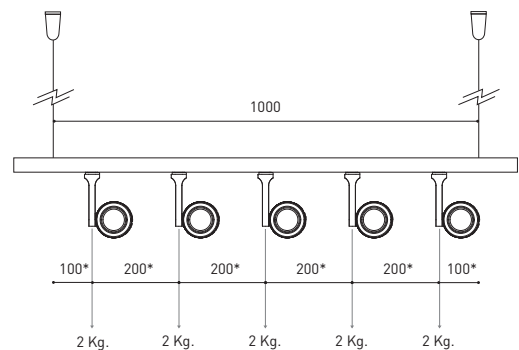

*minimum distance [mm.]

COLOUR | B □ RAL 9016 | N ■ RAL 9005 |



Fuente de luz (LED) reemplazable por un profesional autorizado

Replaceable (LED only) light source by an authorized professional.

Source lumineuse (LED) remplaçable par un professionnel agréé

Sorgente luminosa (LED) sostituibile da parte di un professionista autorizzato

Austauschbare (LED) Lichtquelle durch einen autorisierten Fachmann



Equipo de control reemplazable por un profesional autorizado

Replaceable control gear by an authorized professional

Dispositif de commande remplaçable par un professionnel agréé

Alimentatore sostituibile da parte di un professionista autorizzato

Auswechselbares Betriebsgerät durch autorisierten Fachmann

INSTRUCCIONES PARA EL FINAL DE VIDA Y LA ELIMINACIÓN LOS COMPONENTES
 INSTRUCTIONS ON END-OF-LIFE AND COMPONENT DISPOSAL
 INSTRUCTIONS POUR LA GESTION DES COMPOSANTS EN FIN DE VIE ET LEUR MISE AU REBUT
 ISTRUZIONI PER IL FINE VITA E LO SMALTIMENTO DEI COMPONENTI
 ANWEISUNGEN ZUR ENTSORGUNG DER LEUCHTENKOMPONENTEN



Interrumpir la alimentación del aparato
 Cut the power supply to the luminaire
 Couper l'alimentation du luminaire
 Interrompere l'alimentazione dell'apparecchio
 Stromversorgung der Leuchte unterbrechen



Quitar la(s) fuente(s) de luz para el desecho
 Remove light source(s) for disposal
 Retirer la (les) source(s) lumineuse(s) pour l'élimination
 Rimuovere la/le sorgente/e di luce per lo smaltimento
 Lichtquelle(n) zur Entsorgung entfernen



Quitar la batería para el desecho
 Remove the battery for decommissioning
 Retirer la batterie pour sa mise au rebut
 Rimuovere la batteria per la dismissione
 Die Batterie ordnungsgemäß entsorgen



Quitar el equipo de control para el desecho
 Remove control gear for disposal
 Retirer le dispositif de commande pour l'élimination
 Rimuovere l'alimentatore per lo smaltimento
 Betriebsgerät zur Entsorgung ausbauen



Enviar los materiales a un centro de recogida RAEE
 Send the materials to a WEEE collection centre
 Envoyer les matériaux dans une déchetterie DEEE
 Inviare i materiali ad un centro di raccolta RAEE
 Die Materialien in einem WEEE-Zentrum entsorgen

