

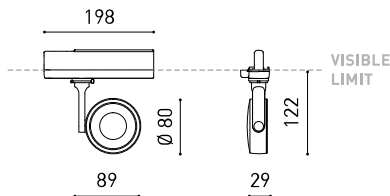

### DIMENSIONI



### ACCESSORI



HIGH CHROMATIC LED



TRACK 3L OPTIONS

### PREMI



### PRODOTTO

Nome	SIX M 2 DIM DALI 19° 2700K NT
Articolo	A3312210NT
Colore	Nero Strutturato
RAL	9005
Categoria	TRACK LIGHTS

### SORGENTE DI LUCE

Tipo	LED
Flusso luminoso lordo	2050 lm
Temperatura di colore	2700 K
Stabilità cromatica	MacAdam Step 2
Indice di Riproduzione Cromatica	CRI > 90
Potenza	17 W
Corrente	500 mA
Efficienza	121 lm/W
Ore di vita del LED	L90B10 > 55.000h

### APPARECCHIO | DATI FOTOMETRICI

Efficienza luminosa	93%
Angolo del fascio di luce	19°

### APPARECCHIO | DATI ELETTRICI

Driver	Incluso
Valori di potenza del sistema	20,07 W
Tensione	220V/240V
Frequenza	50/60 Hz
Regolazione	DALI
Classe di isolamento elettrico	□

### ALTRI DATI

Tenuta stagna	IP20
Wireless control	Consultare
Angolo di oscillazione	310°
Angolo di rotazione	350°
Tipo de carril	Track 3L+N Dimmable
Peso	415 g
Peso compresso l'imballaggio	540 g
Dimensioni dell'imballaggio	309 x 195 x 62 mm
Unità per imballaggio	1
Materiali	Alluminio / Policarbonato



Six è un proiettore per applicazioni a binario o d'incasso che si distingue per la sua leggerezza ed eleganza. Il suo corpo è sagomato a forma di disco, leggermente arrotondato, che racchiude un'innovativa combinazione di riflettore e lente. L'azione congiunta di entrambi permette di dirigere i raggi di luce con la massima uniformità in una distanza minimale che, a sua volta, ha permesso il loro design differenziato - ridotto e minimalista. La famiglia di proiettori di Six si estende dalla taglia XS alla XL, con versioni per binari di bassa e alta tensione, versioni da incasso e versioni doppie.

DIAGRAMMA DI ABBAGLIAMENTO POLARE



DIAGRAMMA CONICO



PER PRESENTAZIONE COMMERCIALE DEL PRODOTTO

Vivid Model Colour Temperature	2700K	3000K	3500K	4000K	Light Pink
📖 Reading			•	•	
🥬 Fruits & Vegetables		•	•		
🍞 Bakery	•				
👤 Retail		•	•		
💄 Cosmetics			•	•	
🍖 Meat					•
🐟 Fish				•	
🐠 Seafood				•	•

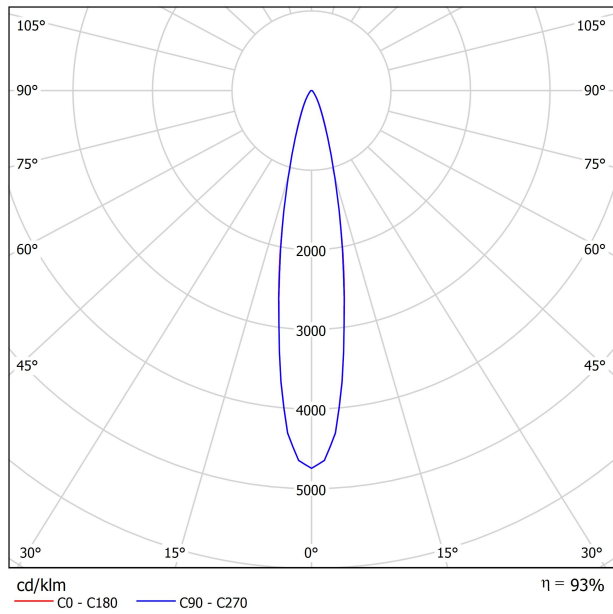
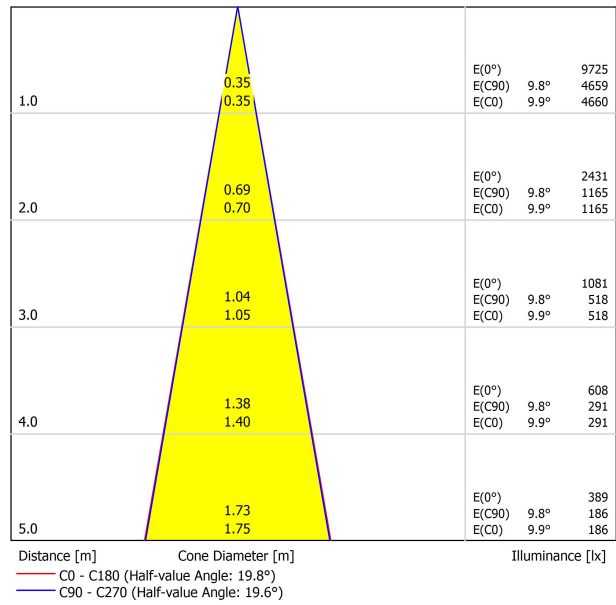

Arkosligh offre su alcuni dei suoi prodotti la possibilità di dotarli di un LED speciale per illuminazione orientata alla promozione visiva di beni e prodotti a scopo commerciale.

Si tratta di un LED ad alta cromaticità che mette in rilievo le tonalità che favoriscono la percezione psicologica positiva dell'oggetto illuminato.

Questa sorgente di luce LED speciale offre una gamma di colori più attraenti e intensi, superiore a quella che può offrire un LED convenzionale. Ciò si ottiene grazie alla configurazione del LED secondo un "parametro speciale di saturazione" che fa in modo che i colori e la texture degli oggetti appaiano più attraenti all'interno dello spettro di luce visibile. A tale scopo si seleziona, in ciascun caso, l'apposito diodo e il suo fosforo di rivestimento specifico.

TRACK 3L+N SURFACE & SUSPENDED



TRACK 3L 1M	A219-21-01-	B	N
TRACK 3L 2M	A219-21-02-	B	N
TRACK 3L 3M	A219-21-03-	B	N



TRACK 3L+N FLUSH MOUNTING

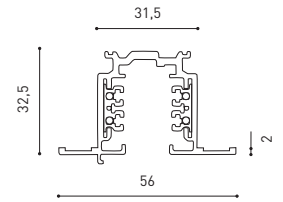
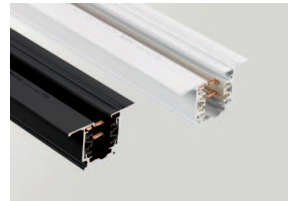

TRACK 3L FLUSH 1M	A219-22-01-	B	N
TRACK 3L FLUSH 2M	A219-22-02-	B	N
TRACK 3L FLUSH 3M	A219-22-03-	B	N

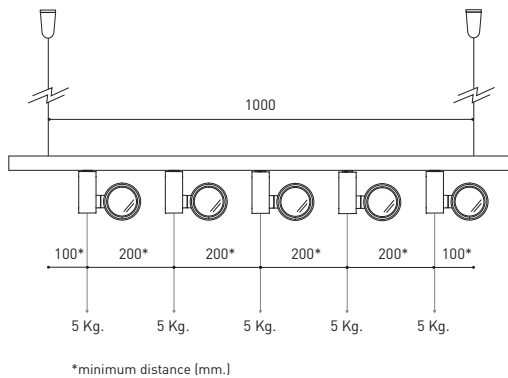

WEIGHT BEAR CAPACITY

Distancia de fijación y capacidad de carga.  
Distancia de fijación recomendada l- 1000mm.

Fastening distance and loading capacity.  
Recommended fastening distance l- 1000mm.

Distance de fixation et capacité de charge.  
Distance de fixation recommandée l- 1000mm.

Distanza di installazione e capacità di carico.  
Distanza consigliata di fissazione l- 1000mm.

Befestigungsabstand und Belastbarkeit.  
Empfohlener Abstand l- 1000mm.

COLOUR | B □ RAL 9016 | N ■ RAL 9005 |

SURFACE & SUSPENDED

FLUSH MOUNTING



POLARITY GROOVE



TRACK 3L Live-End Connector

A219-21-04- | B | N |

A219-21-12- | B | N |



TRACK 3L Central Connector

A219-21-05- | B | N |



TRACK 3L Ceiling Kit

A219-21-06- | B | N |



TRACK 3L Universal Angle

A219-21-07- | B | N |



TRACK 3L 90° Angle

A219-21-08- | B | N |

A219-21-13- | B | N |



TRACK 3L T Joint

A219-21-09- | B | N |

A219-21-14- | B | N |



TRACK 3L Mechanical Joint

A219-21-11- | B | N |



TRACK 3L Suspension Kit

A219-21-10- | B | N |

At least 2 units needed

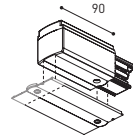

POLARITY GROOVE



TRACK 3L Live-End Connector

A219-21-04- | B | N |

A219-21-12- | B | N |



TRACK 3L FLUSH Cover Plate

A219-22-10- | B | N |

Mandatory for installation

TRACK 3L Central Connector

A219-21-05- | B | N |

TRACK 3L FLUSH Cover Plate

A219-22-10- | B | N |

Mandatory for installation



TRACK 3L FLUSH Ceiling Kit

A219-22-06- | B |



TRACK 3L 90° Angle

A219-21-08- | B | N |

A219-21-13- | B | N |

TRACK 3L FLUSH Corner Cover Plate

A219-22-11- | B | N |

Mandatory for installation



TRACK 3L T Joint

A219-21-09- | B | N |

A219-21-14- | B | N |

TRACK 3L FLUSH Corner Cover Plate

A219-22-11- | B | N |

Mandatory for installation

SURFACE & SUSP. / FLUSH MOUNTING

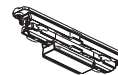

TRACK Contact Joint

A219-20-01- | B | N |



TRACK End

A219-20-02- | B | N |



TRACK Clamp Kit for M6 ROD

A219-21-21- | B |



TRACK Bending Tool

A282-00-00

For tracks its length has been modified

COLOUR | B □ RAL 9016 | N ■ RAL 9005 |



Fuente de luz (LED) reemplazable por un profesional autorizado  
 Replaceable (LED only) light source by an authorized professional.  
 Source lumineuse (LED) remplaçable par un professionnel agréé  
 Sorgente luminosa (LED) sostituibile da parte di un professionista autorizzato  
 Austauschbare (LED) Lichtquelle durch einen autorisierten Fachmann



Equipo de control reemplazable por un profesional autorizado  
 Replaceable control gear by an authorized professional  
 Dispositif de commande remplaçable par un professionnel agréé  
 Alimentatore sostituibile da parte di un professionista autorizzato  
 Auswechselbares Betriebsgerät durch autorisierten Fachmann

INSTRUCCIONES PARA EL FINAL DE VIDA Y LA ELIMINACIÓN LOS COMPONENTES  
 INSTRUCTIONS ON END-OF-LIFE AND COMPONENT DISPOSAL  
 INSTRUCTIONS POUR LA GESTION DES COMPOSANTS EN FIN DE VIE ET LEUR MISE AU REBUT  
 ISTRUZIONI PER IL FINE VITA E LO SMALTIMENTO DEI COMPONENTI  
 ANWEISUNGEN ZUR ENTSORGUNG DER LEUCHTENKOMPONENTEN



Interrumpir la alimentación del aparato  
 Cut the power supply to the luminaire  
 Couper l'alimentation du luminaire  
 Interrompere l'alimentazione dell'apparecchio  
 Stromversorgung der Leuchte unterbrechen



Quitar la(s) fuente(s) de luz para el desecho  
 Remove light source(s) for disposal  
 Retirer la (les) source(s) lumineuse(s) pour l'élimination  
 Rimuovere la/le sorgente/e di luce per lo smaltimento  
 Lichtquelle(n) zur Entsorgung entfernen



Quitar la batería para el desecho  
 Remove the battery for decommissioning  
 Retirer la batterie pour sa mise au rebut  
 Rimuovere la batteria per la dismissione  
 Die Batterie ordnungsgemäß entsorgen



Quitar el equipo de control para el desecho  
 Remove control gear for disposal  
 Retirer le dispositif de commande pour l'élimination  
 Rimuovere l'alimentatore per lo smaltimento  
 Betriebsgerät zur Entsorgung ausbauen

Enviar los materiales a un centro de recogida RAEE  
 Send the materials to a WEEE collection centre  
 Envoyer les matériaux dans une déchetterie DEEE  
 Inviare i materiali ad un centro di raccolta RAEE  
 Die Materialien in einem WEEE-Zentrum entsorgen

