

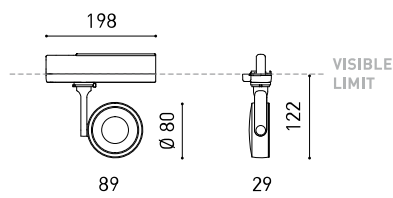

### DIMENSIONS



### ACCESSORIES



HIGH CHROMATIC LED



TRACK 3L OPTIONS

### AWARDS



### PRODUCT

Name	SIX M 2 DIM DALI 28° 2700K WT
Reference	A3312220WT
Color	Textured white
RAL	9016
Category	TRACK LIGHTS

### LIGHT SOURCE

Type	LED
Gross luminous flux	2050 lm
Colour temperature	2700 K
Chromatic stability	MacAdam Step 2
Colour Rendering Index	CRI > 90
Power	17 W
Current	500 mA
Efficacy	121 lm/W
LED lifespan	L90B10 > 55.000h

### LIGHTING FIXTURE | PHOTOMETRIC DATA

Lighting efficiency	91%
Light beam angle	28°

### LIGHTING FIXTURE | ELECTRICAL DATA

Driver	Included
Power values of the system	20,07 W
Frequency	50/60 Hz
Dimming	DALI
Electrical insulation class	□

### OTHER DATA

Sealing	IP20
Wireless control	Please Consult
Swivel angle	310°
Rotation angle	350°
Track type	Track 3L+N Dimmable
Weight	415 g
Packaged weight	540 g
Packaging dimensions	309 x 195 x 62 mm
Units per package	1
Materials	Aluminium / Polycarbonate



Six is a spotlight for either track or single recessed installation, standing out by its optical lightness and elegance. Its body comes in shape of a disk with a slightly convex rim that encloses an innovative combination of reflector and lens. The joint action of both achieves to direct the light beam with maximum uniformity in a minimum distance, which at the same time allowed the differentiated design of Six, compact and minimalist. The Six spotlight range is available from the XS to the XL size, with versions suitable for low and high voltage tracks, recessed versions, and "double" versions, composed of 2 contiguous elements.

POLAR DIAGRAM



CONICAL DIAGRAM

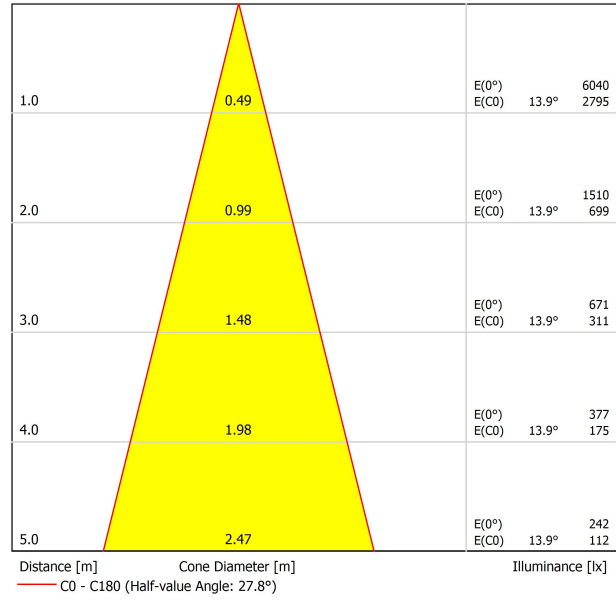

Vivid Model Colour Temperature	2700K	3000K	3500K	4000K	Light Pink
📖 Reading			•	•	
🥬 Fruits & Vegetables		•	•		
🍩 Bakery	•				
👤 Retail		•	•		
💄 Cosmetics			•	•	
🥩 Meat					•
🐟 Fish				•	
🐠 Seafood				•	•



For some of its products, Arkoslight offers the possibility to provide them with a special LED, designed to create an illumination focused on visually promoting goods or products for commercial purposes. It is a high chromaticity LED, capable of identifying the colour shades that produce a positive psychological perception of the illuminated object.

This special LED lighting source offers a much more attractive and intense colour range than a conventional LED, besides being much wider. Technically, this is possible thanks to a special LED setting that includes a «special saturation parameter», capable of highlighting the objects colours and materials in such a way that they seem more attractive within the visible light spectrum. To achieve this performance, in each case, the appropriate diode and specific phosphor coating are carefully selected.

## TRACK 3L+N SURFACE & SUSPENDED

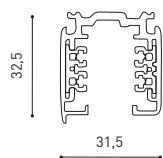

TRACK 3L 1M	A219-21-01-	B	N
TRACK 3L 2M	A219-21-02-	B	N
TRACK 3L 3M	A219-21-03-	B	N



## TRACK 3L+N FLUSH MOUNTING

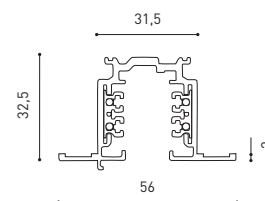
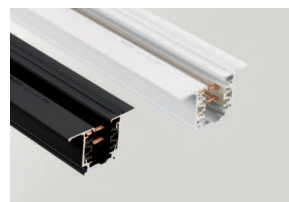

TRACK 3L FLUSH 1M	A219-22-01-	B	N
TRACK 3L FLUSH 2M	A219-22-02-	B	N
TRACK 3L FLUSH 3M	A219-22-03-	B	N

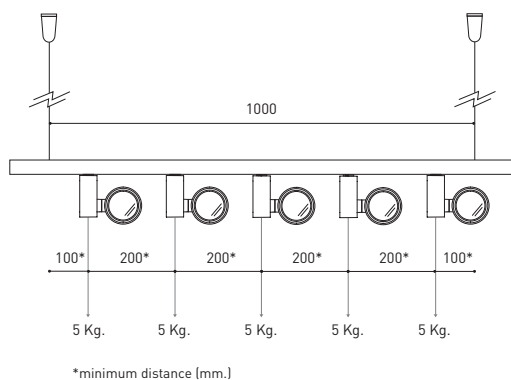

## WEIGHT BEAR CAPACITY

Distancia de fijación y capacidad de carga.  
Distancia de fijación recomendada l- 1000mm.

Fastening distance and loading capacity.  
Recommended fastening distance l- 1000mm.

Distance de fixation et capacité de charge.  
Distance de fixation recommandée l- 1000mm.

Distanza di installazione e capacità di carico.  
Distanza consigliata di fissazione l- 1000mm.

Befestigungsabstand und Belastbarkeit.  
Empfohlener Abstand l- 1000mm.

COLOUR | B □ RAL 9016 | N ■ RAL 9005 |

## SURFACE & SUSPENDED

## FLUSH MOUNTING



POLARITY GROOVE

**TRACK 3L Live-End Connector**

A219-21-04- | B | N |



A219-21-12- | B | N |

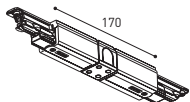

**TRACK 3L Central Connector**

A219-21-05- | B | N |



**TRACK 3L Ceiling Kit**

A219-21-06- | B | N |

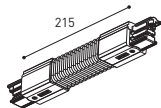

**TRACK 3L Universal Angle**

A219-21-07- | B | N |

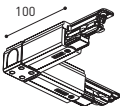

**TRACK 3L 90° Angle**

A219-21-08- | B | N |



A219-21-13- | B | N |

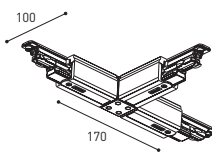

**TRACK 3L T Joint**

A219-21-09- | B | N |



A219-21-14- | B | N |

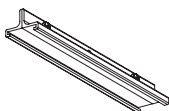

**TRACK 3L Mechanical Joint**

A219-21-11- | B | N |



**TRACK 3L Suspension Kit**

A219-21-10- | B | N |

At least 2 units needed

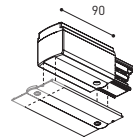

POLARITY GROOVE

**TRACK 3L Live-End Connector**

A219-21-04- | B | N |



A219-21-12- | B | N |

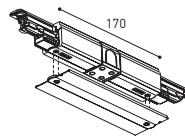

**TRACK 3L Central Connector**

A219-21-05- | B | N |

**TRACK 3L FLUSH Cover Plate**

A219-22-10- | B | N |

Mandatory for installation



**TRACK 3L FLUSH Ceiling Kit**

A219-22-06- | B |

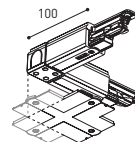

**TRACK 3L 90° Angle**

A219-21-08- | B | N |



A219-21-13- | B | N |

**TRACK 3L FLUSH Corner Cover Plate**

A219-22-11- | B | N |

Mandatory for installation

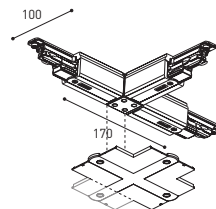

**TRACK 3L T Joint**

A219-21-09- | B | N |



A219-21-14- | B | N |

**TRACK 3L FLUSH Corner Cover Plate**

A219-22-11- | B | N |

Mandatory for installation

## SURFACE & SUSP. / FLUSH MOUNTING

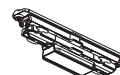

**TRACK Contact Joint**

A219-20-01- | B | N |



**TRACK End**

A219-20-02- | B | N |



**TRACK Clamp Kit for M6 ROD**

A219-21-21- | B |

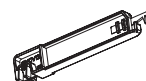

**TRACK Bending Tool**

A282-00-00

For tracks its length has been modified

COLOUR | B □ RAL 9016 | N ■ RAL 9005 |



Fuente de luz (LED) reemplazable por un profesional autorizado

Replaceable (LED only) light source by an authorized professional.

Source lumineuse (LED) remplaçable par un professionnel agréé

Sorgente luminosa (LED) sostituibile da parte di un professionista autorizzato

Austauschbare (LED) Lichtquelle durch einen autorisierten Fachmann



Equipo de control reemplazable por un profesional autorizado

Replaceable control gear by an authorized professional

Dispositif de commande remplaçable par un professionnel agréé

Alimentatore sostituibile da parte di un professionista autorizzato

Auswechselbares Betriebsgerät durch autorisierten Fachmann

INSTRUCCIONES PARA EL FINAL DE VIDA Y LA ELIMINACIÓN LOS COMPONENTES  
 INSTRUCTIONS ON END-OF-LIFE AND COMPONENT DISPOSAL  
 INSTRUCTIONS POUR LA GESTION DES COMPOSANTS EN FIN DE VIE ET LEUR MISE AU REBUT  
 ISTRUZIONI PER IL FINE VITA E LO SMALTIMENTO DEI COMPONENTI  
 ANWEISUNGEN ZUR ENTSORGUNG DER LEUCHTENKOMPONENTEN



Interrumpir la alimentación del aparato  
 Cut the power supply to the luminaire  
 Couper l'alimentation du luminaire  
 Interrompere l'alimentazione dell'apparecchio  
 Stromversorgung der Leuchte unterbrechen



Quitar la(s) fuente(s) de luz para el desecho  
 Remove light source(s) for disposal  
 Retirer la (les) source(s) lumineuse(s) pour l'élimination  
 Rimuovere la/le sorgente/e di luce per lo smaltimento  
 Lichtquelle(n) zur Entsorgung entfernen



Quitar la batería para el desecho  
 Remove the battery for decommissioning  
 Retirer la batterie pour sa mise au rebut  
 Rimuovere la batteria per la dismissione  
 Die Batterie ordnungsgemäß entsorgen



Quitar el equipo de control para el desecho  
 Remove control gear for disposal  
 Retirer le dispositif de commande pour l'élimination  
 Rimuovere l'alimentatore per lo smaltimento  
 Betriebsgerät zur Entsorgung ausbauen



Enviar los materiales a un centro de recogida RAEE  
 Send the materials to a WEEE collection centre  
 Envoyer les matériaux dans une déchetterie DEEE  
 Inviare i materiali ad un centro di raccolta RAEE  
 Die Materialien in einem WEEE-Zentrum entsorgen

