

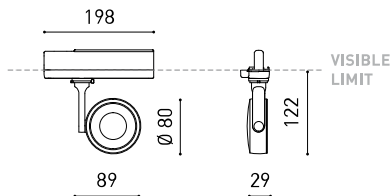

### DIMENSIONS



### ACCESSORIES



HIGH CHROMATIC LED



TRACK 3L OPTIONS

### AWARDS



### PRODUCT

|           |                               |
|-----------|-------------------------------|
| Name      | SIX M 2 DIM DALI 38° 4000K WT |
| Reference | A3312232WT                    |
| Color     | Textured white                |
| RAL       | 9016                          |
| Category  | TRACK LIGHTS                  |

### LIGHT SOURCE

|                        |                  |
|------------------------|------------------|
| Type                   | LED              |
| Gross luminous flux    | 2160 lm          |
| Colour temperature     | 4000 K           |
| Chromatic stability    | MacAdam Step 2   |
| Colour Rendering Index | CRI > 90         |
| Power                  | 17 W             |
| Current                | 500 mA           |
| Efficacy               | 127 lm/W         |
| LED lifespan           | L90B10 > 55.000h |

### LIGHTING FIXTURE | PHOTOMETRIC DATA

|                     |     |
|---------------------|-----|
| Lighting efficiency | 93% |
| Light beam angle    | 38° |

### LIGHTING FIXTURE | ELECTRICAL DATA

|                             |          |
|-----------------------------|----------|
| Driver                      | Included |
| Power values of the system  | 20,07 W  |
| Frequency                   | 50/60 Hz |
| Dimming                     | DALI     |
| Electrical insulation class | □        |

### OTHER DATA

|                      |                           |
|----------------------|---------------------------|
| Sealing              | IP20                      |
| Wireless control     | Please Consult            |
| Swivel angle         | 310°                      |
| Rotation angle       | 350°                      |
| Track type           | Track 3L+N Dimmable       |
| Weight               | 415 g                     |
| Packaged weight      | 540 g                     |
| Packaging dimensions | 309 x 195 x 62 mm         |
| Units per package    | 1                         |
| Materials            | Aluminium / Polycarbonate |



POLAR DIAGRAM



CONICAL DIAGRAM

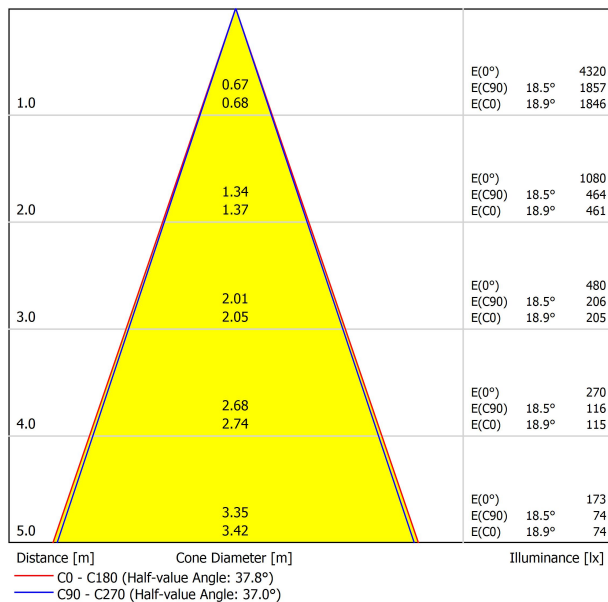

| Vivid Model<br>Colour Temperature | 2700K | 3000K | 3500K | 4000K | Light Pink |
|-----------------------------------|-------|-------|-------|-------|------------|
| 📖 Reading                         |       |       | •     | •     |            |
| 🥬 Fruits & Vegetables             |       | •     | •     |       |            |
| 🍞 Bakery                          | •     |       |       |       |            |
| 👤 Retail                          |       | •     | •     |       |            |
| 💄 Cosmetics                       |       |       | •     | •     |            |
| 🥩 Meat                            |       |       |       |       | •          |
| 🐟 Fish                            |       |       |       | •     |            |
| 🐠 Seafood                         |       |       |       | •     | •          |



For some of its products, Arkoslight offers the possibility to provide them with a special LED, designed to create an illumination focused on visually promoting goods or products for commercial purposes. It is a high chromaticity LED, capable of identifying the colour shades that produce a positive psychological perception of the illuminated object.

This special LED lighting source offers a much more attractive and intense colour range than a conventional LED, besides being much wider. Technically, this is possible thanks to a special LED setting that includes a «special saturation parameter», capable of highlighting the objects colours and materials in such a way that they seem more attractive within the visible light spectrum. To achieve this performance, in each case, the appropriate diode and specific phosphor coating are carefully selected.

## TRACK 3L+N SURFACE & SUSPENDED

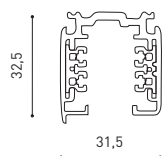

|             |             |   |   |
|-------------|-------------|---|---|
| TRACK 3L 1M | A219-21-01- | B | N |
| TRACK 3L 2M | A219-21-02- | B | N |
| TRACK 3L 3M | A219-21-03- | B | N |



## TRACK 3L+N FLUSH MOUNTING

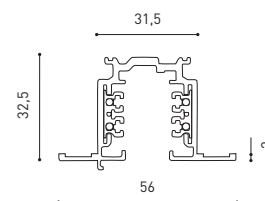
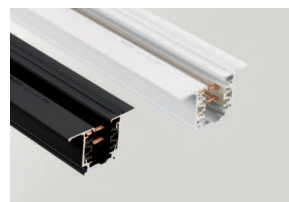

|                   |             |   |   |
|-------------------|-------------|---|---|
| TRACK 3L FLUSH 1M | A219-22-01- | B | N |
| TRACK 3L FLUSH 2M | A219-22-02- | B | N |
| TRACK 3L FLUSH 3M | A219-22-03- | B | N |

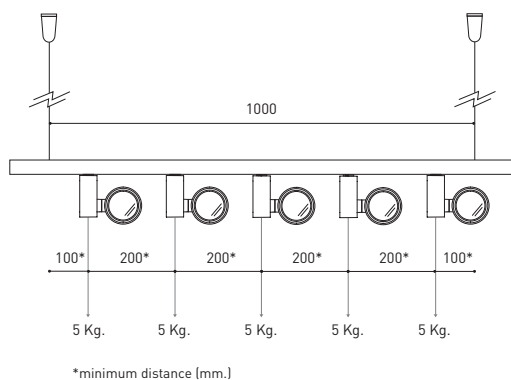

## WEIGHT BEAR CAPACITY

Distancia de fijación y capacidad de carga.  
Distancia de fijación recomendada l- 1000mm.

Fastening distance and loading capacity.  
Recommended fastening distance l- 1000mm.

Distance de fixation et capacité de charge.  
Distance de fixation recommandée l- 1000mm.

Distanza di installazione e capacità di carico.  
Distanza consigliata di fissazione l- 1000mm.

Befestigungsabstand und Belastbarkeit.  
Empfohlener Abstand l- 1000mm.

COLOUR | B □ RAL 9016 | N ■ RAL 9005 |

Calle N · Pol. Ind. EL OLIVERAL  
46394 Ribarroja del Turia · Valencia (Spain)  
Tel. +34 961 667 207 · Fax +34 961 667 054  
info@arkoslight.com · www.arkoslight.com



## SURFACE & SUSPENDED

## FLUSH MOUNTING



POLARITY GROOVE



### TRACK 3L Live-End Connector

A219-21-04- | B | N |

A219-21-12- | B | N |

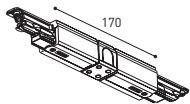

### TRACK 3L Central Connector

A219-21-05- | B | N |



### TRACK 3L Ceiling Kit

A219-21-06- | B | N |

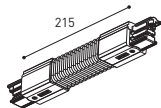

### TRACK 3L Universal Angle

A219-21-07- | B | N |

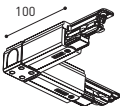

### TRACK 3L 90° Angle

A219-21-08- | B | N |

A219-21-13- | B | N |

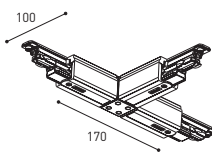

### TRACK 3L T Joint

A219-21-09- | B | N |

A219-21-14- | B | N |

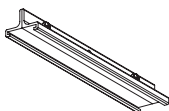

### TRACK 3L Mechanical Joint

A219-21-11- | B | N |



### TRACK 3L Suspension Kit

A219-21-10- | B | N |

At least 2 units needed

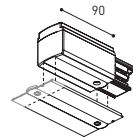

POLARITY GROOVE



### TRACK 3L Live-End Connector

A219-21-04- | B | N |

A219-21-12- | B | N |

### TRACK 3L FLUSH Cover Plate

A219-22-10- | B | N |

Mandatory for installation

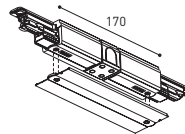

### TRACK 3L Central Connector

A219-21-05- | B | N |

### TRACK 3L FLUSH Cover Plate

A219-22-10- | B | N |

Mandatory for installation



### TRACK 3L FLUSH Ceiling Kit

A219-22-06- | B |

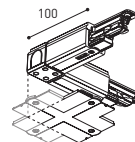

### TRACK 3L 90° Angle

A219-21-08- | B | N |

A219-21-13- | B | N |

### TRACK 3L FLUSH Corner Cover Plate

A219-22-11- | B | N |

Mandatory for installation

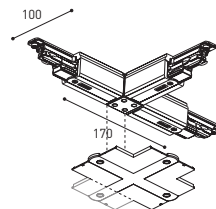

### TRACK 3L T Joint

A219-21-09- | B | N |

A219-21-14- | B | N |

### TRACK 3L FLUSH Corner Cover Plate

A219-22-11- | B | N |

Mandatory for installation

## SURFACE & SUSP. / FLUSH MOUNTING

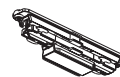

### TRACK Contact Joint

A219-20-01- | B | N |



### TRACK End

A219-20-02- | B | N |



### TRACK Clamp Kit for M6 ROD

A219-21-21- | B |

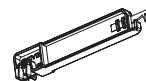

### TRACK Bending Tool

A282-00-00

For tracks its length has been modified

COLOUR | B □ RAL 9016 | N ■ RAL 9005 |



Fuente de luz (LED) reemplazable por un profesional autorizado  
 Replaceable (LED only) light source by an authorized professional.  
 Source lumineuse (LED) remplaçable par un professionnel agréé  
 Sorgente luminosa (LED) sostituibile da parte di un professionista autorizzato  
 Austauschbare (LED) Lichtquelle durch einen autorisierten Fachmann



Equipo de control reemplazable por un profesional autorizado  
 Replaceable control gear by an authorized professional  
 Dispositif de commande remplaçable par un professionnel agréé  
 Alimentatore sostituibile da parte di un professionista autorizzato  
 Auswechselbares Betriebsgerät durch autorisierten Fachmann

INSTRUCCIONES PARA EL FINAL DE VIDA Y LA ELIMINACIÓN LOS COMPONENTES  
 INSTRUCTIONS ON END-OF-LIFE AND COMPONENT DISPOSAL  
 INSTRUCTIONS POUR LA GESTION DES COMPOSANTS EN FIN DE VIE ET LEUR MISE AU REBUT  
 ISTRUZIONI PER IL FINE VITA E LO SMALTIMENTO DEI COMPONENTI  
 ANWEISUNGEN ZUR ENTSORGUNG DER LEUCHTENKOMPONENTEN



Interrumpir la alimentación del aparato  
 Cut the power supply to the luminaire  
 Couper l'alimentation du luminaire  
 Interrompere l'alimentazione dell'apparecchio  
 Stromversorgung der Leuchte unterbrechen



Quitar la(s) fuente(s) de luz para el desecho  
 Remove light source(s) for disposal  
 Retirer la (les) source(s) lumineuse(s) pour l'élimination  
 Rimuovere la/le sorgente/e di luce per lo smaltimento  
 Lichtquelle(n) zur Entsorgung entfernen



Quitar la batería para el desecho  
 Remove the battery for decommissioning  
 Retirer la batterie pour sa mise au rebut  
 Rimuovere la batteria per la dismissione  
 Die Batterie ordnungsgemäß entsorgen



Quitar el equipo de control para el desecho  
 Remove control gear for disposal  
 Retirer le dispositif de commande pour l'élimination  
 Rimuovere l'alimentatore per lo smaltimento  
 Betriebsgerät zur Entsorgung ausbauen

Enviar los materiales a un centro de recogida RAEE  
 Send the materials to a WEEE collection centre  
 Envoyer les matériaux dans une déchetterie DEEE  
 Inviare i materiali ad un centro di raccolta RAEE  
 Die Materialien in einem WEEE-Zentrum entsorgen

