

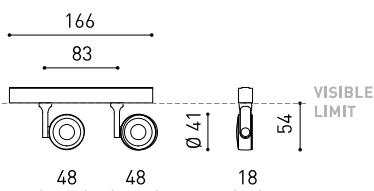

### Dimensions



### Accessoires



HIGH CHROMATIC LED



TRACK 48V OPTIONS

### Prix



### PRODUIT

Nom	SIX XS 48V SHORT DOUBLE DIM DALI 23° 2700K WT
Référence	A3351220WT-S
Couleur	Blanc Texturé
RAL	9016
Catégorie	TRACK LIGHTS

### SOURCE DE LUMIÈRE

Type	LED
Flux lumineux brut	2 x 470 lm
Température de couleur	2700 K
Stabilité chromatique	MacAdam Step 2
Indice de reproduction chromatique	CRI > 90
Puissance	9 W
Efficacité	104 lm/W
Durée de vie de la LED	L90B10 > 55.000h
Classe d'efficacité énergétique	F

### LUMINAIRE | DONNÉES PHOTOMÉTRIQUES

Efficacité lumineuse	86%
Angle du faisceau lumineux	23°

### LUMINAIRE | DONNÉES ÉLECTRIQUES

Valeurs de puissance du système	10,20 W
Tension	48Vdc
Variation d'intensité	DALI
Classe d'isolation électrique	◆

### D'AUTRES DONNÉES

Étanchéité	IP20
Contrôle sans fil	Veillez consulter
Angle d'inclinaison	310°
Angle de rotation	360°
Type de rail	Track 48V
Poids	168 g
Poids avec emballage	215 g
Dimensions de l'emballage	190 x 145 x 24 mm
Unités par emballage	1
Matériaux	Aluminium / Polycarbonate



Six 48V est une gamme de projecteurs pour applications de rail à basse tension qui se distingue par sa légèreté et son élégance. Disponible en tailles L, M, S, XS et XS Double, son corps présente une forme de disque légèrement arrondi, qui renferme une combinaison innovante de réflecteur et de lentille. L'action conjointe des deux parvient à diriger les rayons de lumière avec la plus grande uniformité sur une distance minimale qui, à son tour, a permis à leur conception différenciée - réduite et minimaliste -. De plus, son bras articulé offre une grande mobilité pour guider la pièce dans toutes les directions.

Diagramme polaire









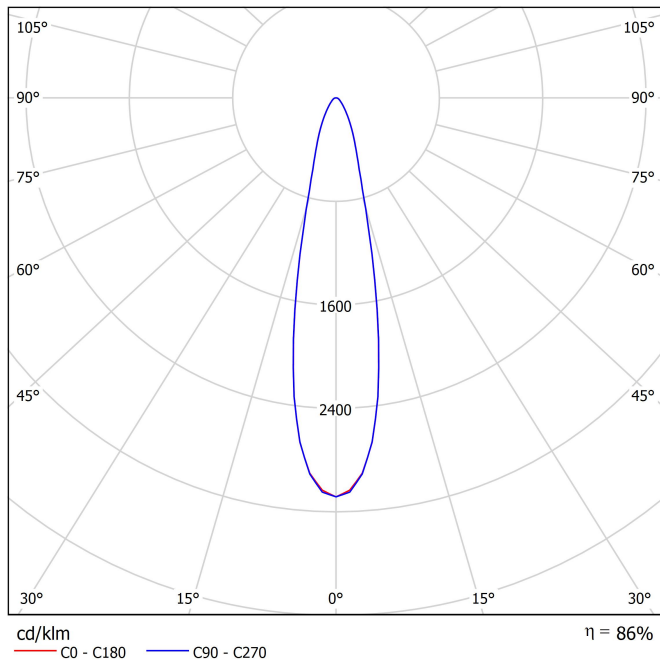
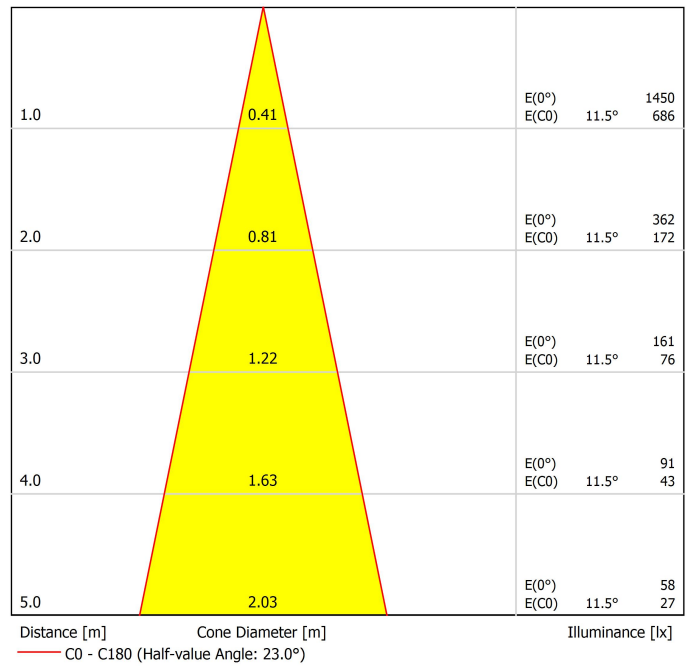

Diagramme conique



Vivid Model Colour Temperature	2700K	3000K	3500K	4000K	Light Pink
 Reading			•	•	
 Fruits & Vegetables		•	•		
 Bakery	•				
 Retail		•	•		
 Cosmetics			•	•	
 Meat					•
 Fish				•	
 Seafood				•	•

## High Chromatic LED

### Pour présentation commerciale du produit.

Arkoslight vous offre sur certains de ses produits la possibilité de les équiper d'un LED spécial, qui a été conçu pour une illumination orientée à la promotion visuelle de biens ou produits à des fins commerciales.

Il s'agit d'un LED de haute chromaticité permettant de mettre en évidence les tons qui favorisent une perception psychologique positive de l'objet illuminé.

Cette source de lumière LED spéciale vous offre une palette de couleurs plus attractive et intense, et plus vaste que celle d'un LED conventionnel. Ceci est possible grâce à la configuration du LED qui inclue un "paramètre spécial de saturation", lequel réussit à ce que les couleurs et la texture des objets apparaissent de manière plus attractive dans le spectre de lumière visible. Pour ce faire, le diode correspondant est sélectionné en fonction de chaque cas, et il en est de même pour son revêtement spécifique en phosphore.

# Track 48V Surface Short

# ARKOSLIGHT

48V track lighting systems are low-voltage lighting solutions based on electrified tracks. The track serves both as a physical structure and as a power carrier, allowing light modules to be placed and repositioned as needed, offering flexibility, safety, and energy efficiency. Ideal for projects that demand minimalist design, high performance, and adaptability. To configure your 48V system, you'll need to combine the following components:

1. Tracks - Available in surface, trimless, surface short, suspended (using suspension accessories with the surface track), and indirect light versions. They form the structural and electrical base of the system.
2. Connectors & Power Supply - Ensure electrical continuity between track sections and provide the 48V power input.
3. Accessories - Including end caps, joiners, mounting elements, and optional installation accessories to complete and secure the setup.



## Track Options

Choose the track version required for your project configuration.

TRACK 48V SURFACE SHORT 1m	A338-21-00-   NT   WT
TRACK 48V SURFACE SHORT 2m	A338-22-00-   NT   WT
TRACK 48V SURFACE SHORT 3m	A338-23-00-   NT   WT

TRACK 48V SURFACE SHORT Corner 90° One Plane	A338-24-00-   NT   WT
TRACK 48V SURFACE SHORT T-Joint	A338-25-00-   NT
TRACK 48V SURFACE SHORT X-Joint	A338-26-00-   NT

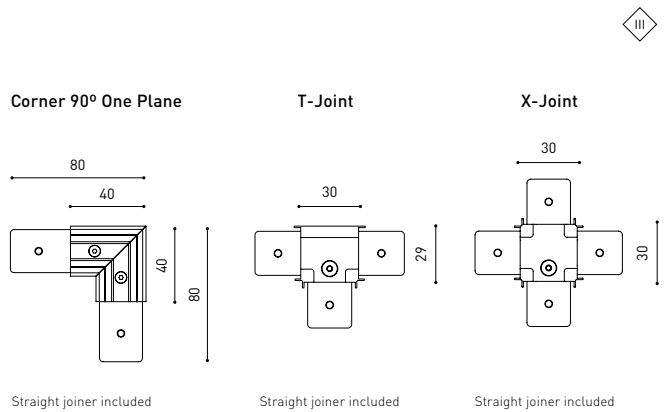
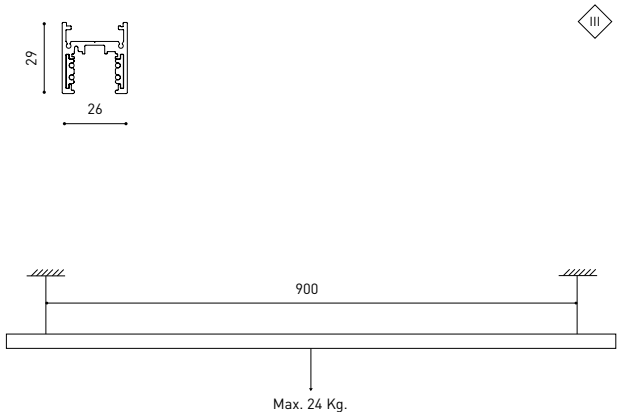

## Complementary track accessories

Use end caps, joiners, and gap covers to connect, close, and cleanly finish your track setup.

Short End 48V	
A338-00-18-   NT   WT	

Surface Straight Joiner 48V	
A338-00-11	

Short End Feed 48V	
A338-00-19-   NT   WT	

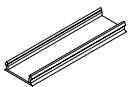
Cover Gap 1m 48V	
A338-00-30-   N   W	

COLOUR | NT ■ RAL 9005 | WT □ RAL 9016 | N ■ RAL 9005 |

## Connector options

Connectors are required to provide electrical continuity between tracks, ensuring an uninterrupted 48V flow.

### Live-End Connector 48V

A338-00-01- | N |

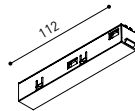

### Central Connector 48V

A338-00-02- | N |

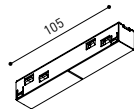

### T-Joint Connector 48V

A450-00-07- | N |

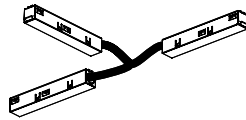

### Wireless Control 48V

0434-01-31- | N | W |

Casambi

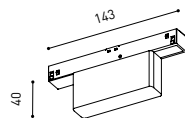

### Corner 90° Connector One Plane 48V

A338-00-24- | N | W |

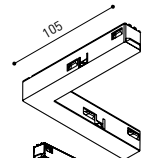

### L-Joint Connector 48V

A338-00-12- | N |

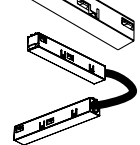

### X-Joint Connector 48V

A450-00-08- | N |

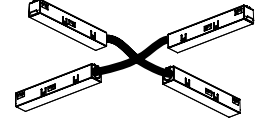

## Power Supply Options

Select the appropriate power feed to deliver 48V to the system based on your track layout and installation type.

### For all tracks

#### Constant Voltage LED POWER SUPPLY

	P	V	D (A x B x C)
0434-01-61*   N   W	100W	48V	298 x 19 x 16mm
0434-01-62	150W	48V	350 x 30 x 18mm
0434-01-80	250W	48V	400 x 40 x 22mm

220 V~ / 240 V~ | \*To be installed inside the track.

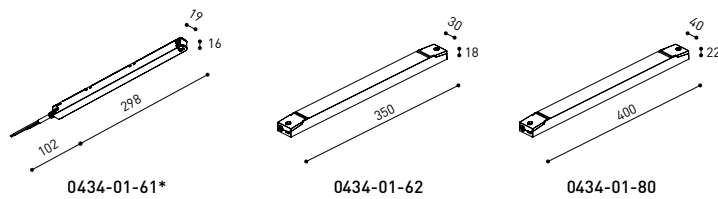

#### DROP VOLTAGE TABLE

POWER (W)	CABLE SECTION (mm <sup>2</sup> )	CABLE LENGTH (m)			
		5	10	20	30
100	0,75	50	50	X	X
	1,5	50	50	40	25
150	0,75	40	15	X	X
	1,5	50	40	20	X
250	0,75	20	X	X	X
	1,5	35	20	X	X

## Connection diagrams:

### Surface

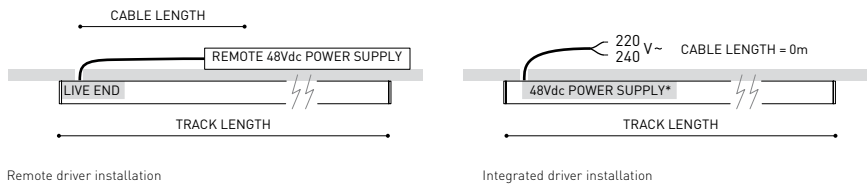

### Suspension

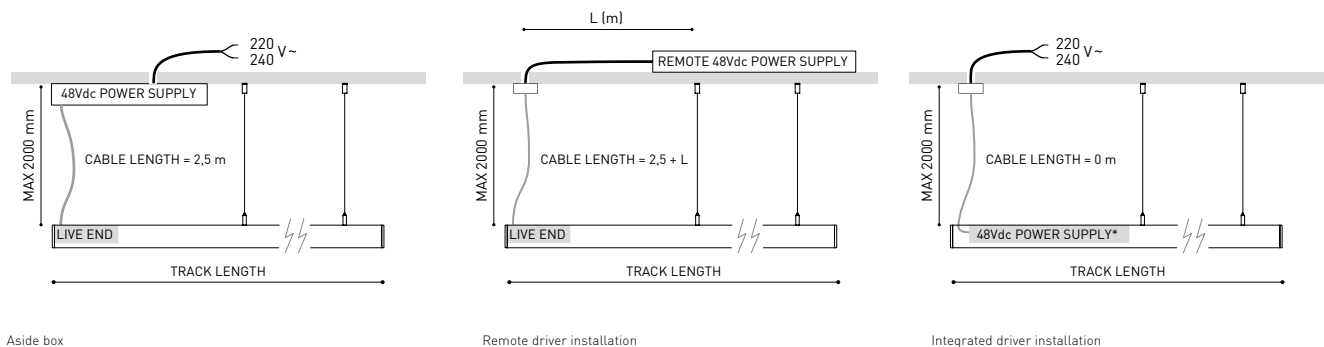

COLOUR | N ■ RAL 9005 |

## Other accessories

### Suspension components

For a suspended configuration, use surface components together with the following accessories:

<b>SURFACE Suspension Kit (2 units) 48V</b>			
A338-00-15-	NT   WT		



For suspension aside box installation replace the power supply:

<b>Wired Power Supply Case 48V</b>			
A338-00-25-	NT   WT	150W	NO DIM
A338-00-26-	NT   WT	150W	DIM

220  
240 V~ INCL

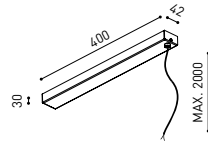

Required for remote or integrated driver installation:

<b>Suspension Feed Kit 48V</b>			
A338-00-16-	N   W		NO DIM
A338-00-17-	N   W		DIM

For remote power supply

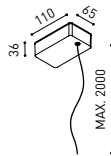

A338-00-27-	N   W		NO DIM
A338-00-28-	N   W		DIM

For power supply inside the track

### Wire trimless accessories

For installing the suspension system cleanly and discreetly – with no visible ceiling boxes or mounting elements.

#### FEED

<b>Mains Trimless*</b>			
A023-00-01-	W   N		NO DIM

<b>Mains Thick Trimless*</b>			
A023-00-02-	W   N		DIM

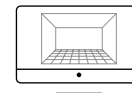
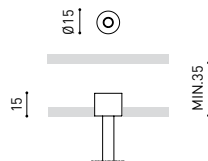

#### PRODUCT CONFIGURATOR

Use our online configurator to design your own custom product layout. The tool will guide you through the process and automatically calculate the required drivers and accessories.

[Start your configuration ->](#)

#### FASTENING

<b>Steel Cable Trimless*</b>			
A023-00-05-	W   N		

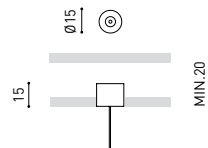

\* As many pieces as needed according to your product

COLOUR | NT ■ RAL 9005 | WT □ RAL 9016 | N ■ RAL 9005 | W □ RAL 9016 |

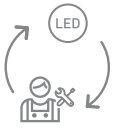

Fuente de luz (LED) reemplazable por un profesional autorizado

Replaceable (LED only) light source by an authorized professional.

Source lumineuse (LED) remplaçable par un professionnel agréé

Sorgente luminosa (LED) sostituibile da parte di un professionista autorizzato

Austauschbare (LED) Lichtquelle durch einen autorisierten Fachmann



Equipo de control reemplazable por un profesional autorizado

Replaceable control gear by an authorized professional

Dispositif de commande remplaçable par un professionnel agréé

Alimentatore sostituibile da parte di un professionista autorizzato

Auswechselbares Betriebsgerät durch autorisierten Fachmann

## Instrucciones para el final de vida y la eliminación de los componentes:

### Instructions on end-of-life and component disposal:

### Instructions pour la gestion des composants en fin de vie et leur mise au rebut :

### Istruzioni per il fine vita e lo smaltimento dei componenti:

### Anweisungen zur entsorgung der Leuchtenkomponenten:



Interrumpir la alimentación del aparato  
Cut the power supply to the luminaire  
Couper l'alimentation du luminaire  
Interrompere l'alimentazione dell'apparecchio  
Stromversorgung der Leuchte unterbrechen



Quitar la(s) fuente(s) de luz para el desecho  
Remove light source(s) for disposal  
Retirer la (les) source(s) lumineuse(s) pour l'élimination  
Rimuovere la/le sorgente/e di luce per lo smaltimento  
Lichtquelle(n) zur Entsorgung entfernen

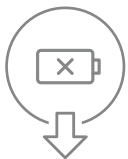

Quitar la batería para el desecho  
Remove the battery for decommissioning  
Retirer la batterie pour sa mise au rebut  
Rimuovere la batteria per la dismissione  
Die Batterie ordnungsgemäß entsorgen



Quitar el equipo de control para el desecho  
Remove control gear for disposal  
Retirer le dispositif de commande pour l'élimination  
Rimuovere l'alimentatore per lo smaltimento  
Betriebsgerät zur Entsorgung ausbauen



Enviar los materiales a un centro de recogida RAEE  
Send the materials to a WEEE collection centre  
Envoyer les matériaux dans une déchetterie DEEE  
Inviare i materiali ad un centro di raccolta RAEE  
Die Materialien in einem WEEE-Zentrum entsorgen

