

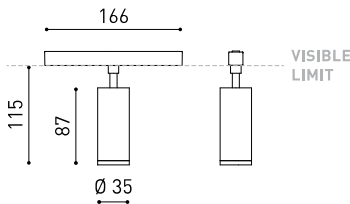

Dimensiones



Accesorios



ANTI-GLARE HONEYCOMB LOUVER



TRACK 48V OPTIONS

PRODUCTO

Nombre	FIT 35 48V SHORT FLOOD 4000K NT
Referencia	A3450132NT-S
Color	Negro Texturado
RAL	9005
Categoría	TRACK LIGHTS

FUENTE DE LUZ

Tipo	LED
Flujo luminoso	710 lm
Temperatura de color	4000 K
Estabilidad cromática	MacAdam Step 2
Índice de reproducción cromática	CRI > 90
Potencia	5,5 W
Corriente	500 mA
Eficacia	127 lm/W
Horas de vida del LED	L90B10 > 108.000h
Eficiencia energética	E

LUMINARIA | DATOS FOTOMÉTRICOS

Eficiencia lumínica	85%
Ángulo del haz de luz	36°

LUMINARIA | DATOS ELÉCTRICOS

Potencia del sistema	6,32 W
Tensión	48Vdc
Regulación	No Dim
Clase de seguridad eléctrica	⚡

OTROS DATOS

Estanqueidad	IP20
Control inalámbrico	Consultar
Ángulo de basculación	90°
Ángulo de giro	360°
Tipo de carril	Track 48V
Peso	180 g
Peso con embalaje	250 g
Dimensiones embalaje	188 x 165 x 53 mm
Unidades por embalaje	1
Materiales	Aluminio / Policarbonato



Fit es un proyector para aplicaciones de carril de bajo voltaje disponible en diferentes modelos (50, 35, 35 Double, 27, 27 Double, 20 y 20 Double). De geometría cilíndrica y formas esenciales, destaca por su minimalismo estético y su funcionalidad, ya que puede orientarse en todas las direcciones. El perímetro de su boca en negro y su accesorio de lamas tipo panel de abeja acentúan su vocación antideslumbramiento.

Diagrama polar



Diagrama cónico



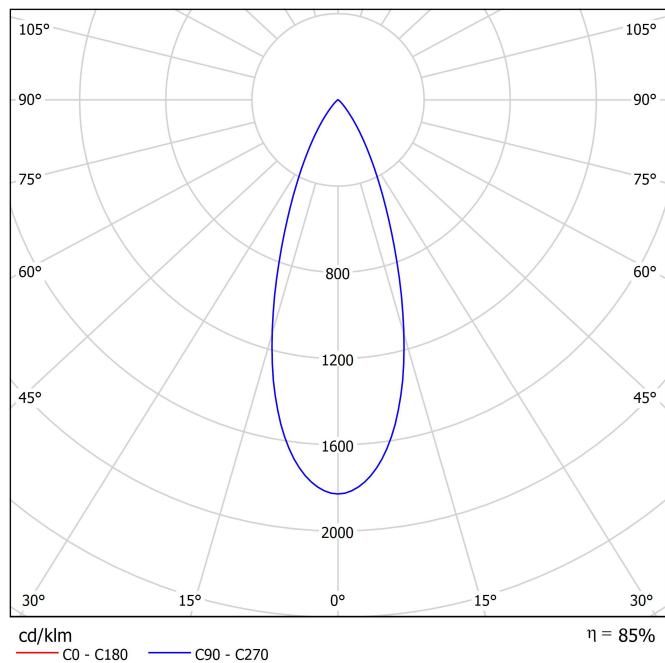
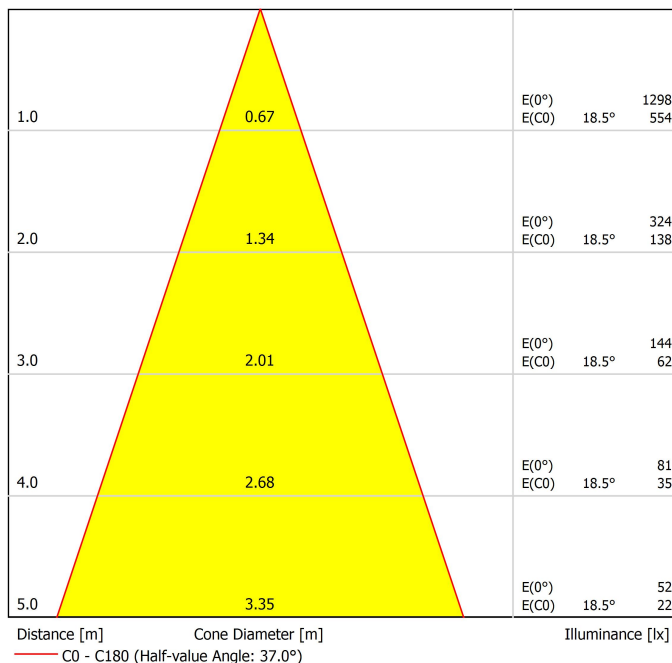

	PRODUCT
Model	Anti-glare Honeycomb Louver
Reference	A3450000
Category	Accessories

NO SE VENDE POR SEPARADO 

Rejilla tipo panal antideslumbrante

Accesorio compuesto por una rejilla en forma de panal que controla el haz de luz, reduce el deslumbramiento y protege la visión directa de la fuente luminosa.

Track 48V Surface Short

ARKOSLIGHT

48V track lighting systems are low-voltage lighting solutions based on electrified tracks. The track serves both as a physical structure and as a power carrier, allowing light modules to be placed and repositioned as needed, offering flexibility, safety, and energy efficiency. Ideal for projects that demand minimalist design, high performance, and adaptability. To configure your 48V system, you'll need to combine the following components:

1. Tracks - Available in surface, trimless, surface short, suspended (using suspension accessories with the surface track), and indirect light versions. They form the structural and electrical base of the system.
2. Connectors & Power Supply - Ensure electrical continuity between track sections and provide the 48V power input.
3. Accessories - Including end caps, joiners, mounting elements, and optional installation accessories to complete and secure the setup.



Track Options

Choose the track version required for your project configuration.

TRACK 48V SURFACE SHORT 1m	A338-21-00- NT WT
TRACK 48V SURFACE SHORT 2m	A338-22-00- NT WT
TRACK 48V SURFACE SHORT 3m	A338-23-00- NT WT

TRACK 48V SURFACE SHORT Corner 90° One Plane	A338-24-00- NT WT
TRACK 48V SURFACE SHORT T-Joint	A338-25-00- NT
TRACK 48V SURFACE SHORT X-Joint	A338-26-00- NT

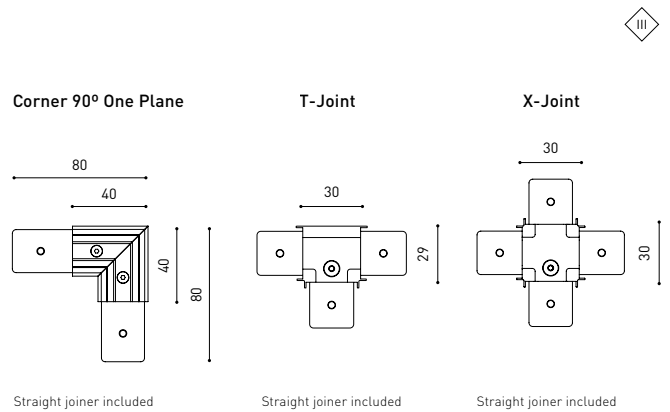
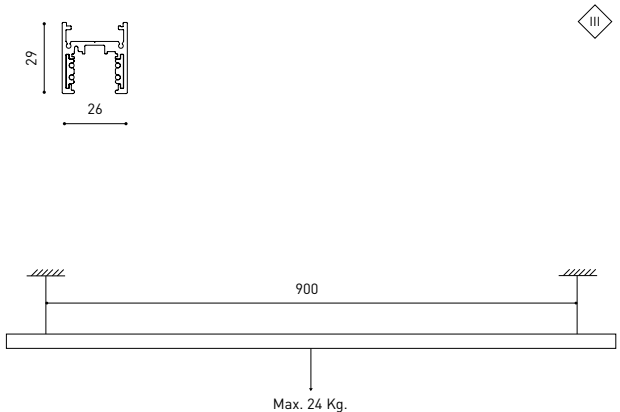

Complementary track accessories

Use end caps, joiners, and gap covers to connect, close, and cleanly finish your track setup.

Short End 48V	
A338-00-18- NT WT	

Surface Straight Joiner 48V	
A338-00-11	

Short End Feed 48V	
A338-00-19- NT WT	

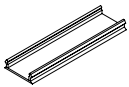
Cover Gap 1m 48V	
A338-00-30- N W	

COLOUR | NT ■ RAL 9005 | WT □ RAL 9016 | N ■ RAL 9005 |

Connector options

Connectors are required to provide electrical continuity between tracks, ensuring an uninterrupted 48V flow.

Live-End Connector 48V

A338-00-01- | N |

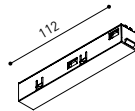

Central Connector 48V

A338-00-02- | N |

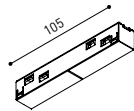

T-Joint Connector 48V

A450-00-07- | N |

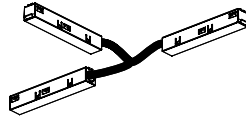

Wireless Control 48V

0434-01-31- | N | W |

Casambi

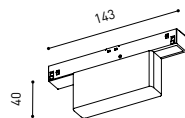

Corner 90° Connector One Plane 48V

A338-00-24- | N | W |

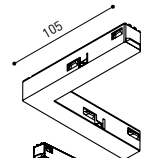

L-Joint Connector 48V

A338-00-12- | N |

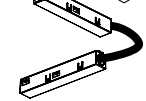

X-Joint Connector 48V

A450-00-08- | N |

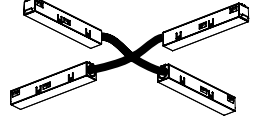

Power Supply Options

Select the appropriate power feed to deliver 48V to the system based on your track layout and installation type.

For all tracks

Constant Voltage LED POWER SUPPLY

	P	V	D (A x B x C)
0434-01-61* N W	100W	48V	298 x 19 x 16mm
0434-01-62	150W	48V	350 x 30 x 18mm
0434-01-80	250W	48V	400 x 40 x 22mm

220 V~ / 240 V~ | *To be installed inside the track.

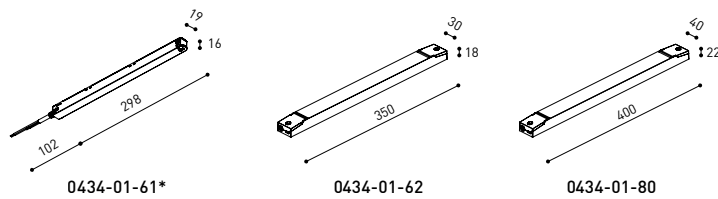

DROP VOLTAGE TABLE

POWER (W)	CABLE SECTION (mm ²)	CABLE LENGTH (m)			
		5	10	20	30
100	0,75	50	50	X	X
	1,5	50	50	40	25
150	0,75	40	15	X	X
	1,5	50	40	20	X
250	0,75	20	X	X	X
	1,5	35	20	X	X

Connection diagrams:

Surface

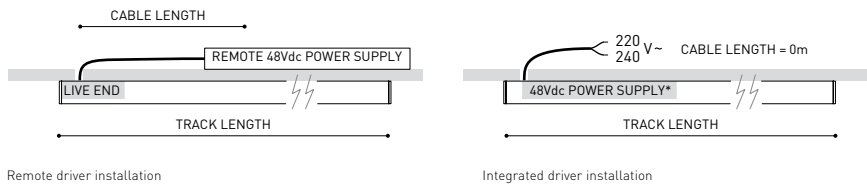

Suspension

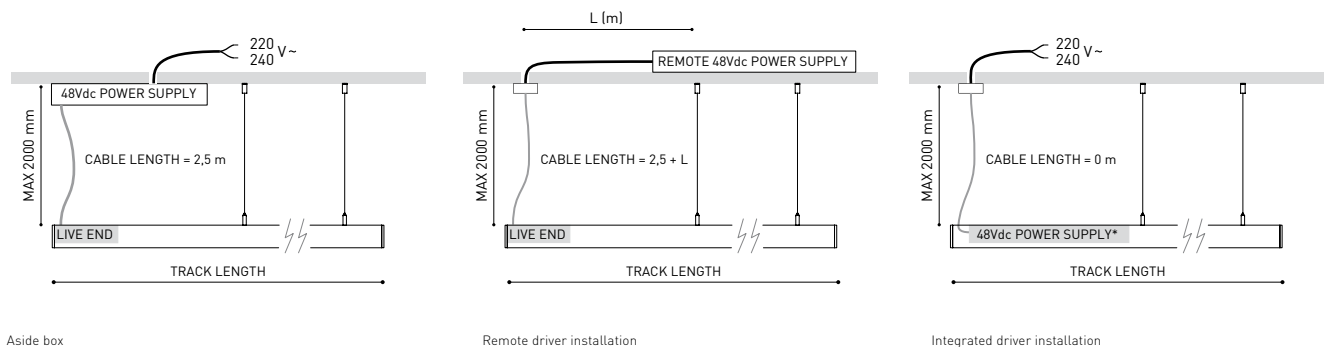

COLOUR | N ■ RAL 9005 |

Other accessories

Suspension components

For a suspended configuration, use surface components together with the following accessories:

SURFACE Suspension Kit (2 units) 48V			
A338-00-15-	NT WT		

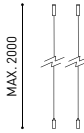

For suspension aside box installation replace the power supply:

Wired Power Supply Case 48V

A338-00-25-	NT WT	150W	NO DIM
A338-00-26-	NT WT	150W	DIM

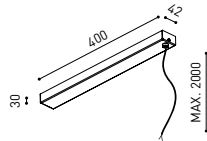
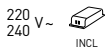

Required for remote or integrated driver installation:

Suspension Feed Kit 48V

A338-00-16-	N W	NO DIM
A338-00-17-	N W	DIM

For remote power supply

A338-00-27-	N W	NO DIM
A338-00-28-	N W	DIM

For power supply inside the track

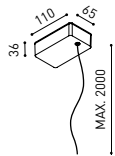

Alternative surface installation

For aside box installation replace the power supply:

Power Supply Case 48V

A338-00-29-	NT WT	150W
-------------	---------	------

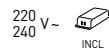

*To be installed aside 48V Surface Tracks

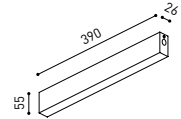

Wire trimless accessories

For installing the suspension system cleanly and discreetly — with no visible ceiling boxes or mounting elements.

FEED

Mains Trimless*

A023-00-01-	W N	NO DIM
-------------	-------	--------

Mains Thick Trimless*

A023-00-02-	W N	DIM
-------------	-------	-----

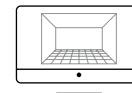
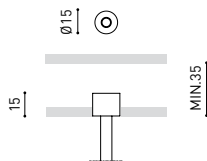

PRODUCT CONFIGURATOR

Use our online configurator to design your own custom product layout. The tool will guide you through the process and automatically calculate the required drivers and accessories.

[Start your configuration ->](#)

FASTENING

Steel Cable Trimless*

A023-00-05-	W N
-------------	-------

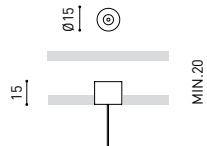

* As many pieces as needed according to your product

COLOUR | NT ■ RAL 9005 | WT □ RAL 9016 | N ■ RAL 9005 | W □ RAL 9016 |

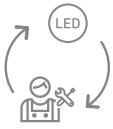

Fuente de luz (LED) reemplazable por un profesional autorizado

Replaceable (LED only) light source by an authorized professional.

Source lumineuse (LED) remplaçable par un professionnel agréé

Sorgente luminosa (LED) sostituibile da parte di un professionista autorizzato

Austauschbare (LED) Lichtquelle durch einen autorisierten Fachmann



Equipo de control reemplazable por un profesional autorizado

Replaceable control gear by an authorized professional

Dispositif de commande remplaçable par un professionnel agréé

Alimentatore sostituibile da parte di un professionista autorizzato

Auswechselbares Betriebsgerät durch autorisierten Fachmann

Instrucciones para el final de vida y la eliminación de los componentes:

Instructions on end-of-life and component disposal:

Instructions pour la gestion des composants en fin de vie et leur mise au rebut :

Istruzioni per il fine vita e lo smaltimento dei componenti:

Anweisungen zur entsorgung der Leuchtenkomponenten:



Interrumpir la alimentación del aparato
Cut the power supply to the luminaire
Couper l'alimentation du luminaire
Interrompere l'alimentazione dell'apparecchio
Stromversorgung der Leuchte unterbrechen



Quitar la(s) fuente(s) de luz para el desecho
Remove light source(s) for disposal
Retirer la (les) source(s) lumineuse(s) pour l'élimination
Rimuovere la/le sorgente/e di luce per lo smaltimento
Lichtquelle(n) zur Entsorgung entfernen

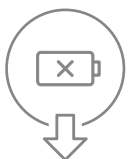

Quitar la batería para el desecho
Remove the battery for decommissioning
Retirer la batterie pour sa mise au rebut
Rimuovere la batteria per la dismissione
Die Batterie ordnungsgemäß entsorgen



Quitar el equipo de control para el desecho
Remove control gear for disposal
Retirer le dispositif de commande pour l'élimination
Rimuovere l'alimentatore per lo smaltimento
Betriebsgerät zur Entsorgung ausbauen



Enviar los materiales a un centro de recogida RAEE
Send the materials to a WEEE collection centre
Envoyer les matériaux dans une déchetterie DEEE
Inviare i materiali ad un centro di raccolta RAEE
Die Materialien in einem WEEE-Zentrum entsorgen

