

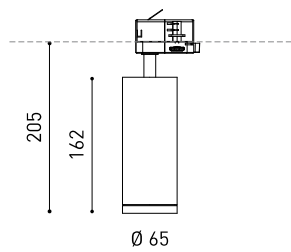

Größe



Zubehör



ANTI-GLARE HONEYCOMB
LOUVER



TRACK 3L OPTIONS

PRODUKT

Name	FIT 65 SPOT 4000K WT
Artikelnummer	A3560112WT
Farbe	Weiß strukturiert
RAL	9016
Kategorie	TRACK LIGHTS

LICHTQUELLE

Typ	LED
Bruttolichtstrom	1320 lm
Farbtemperatur	4000 K
Farbstabilität	MacAdam Step 2
Farbwiedergabeindex	CRI>90
Leistung	10,3 W
Stromstärke	300 mA
Lichtausbeute	128 lm/W
Nutzlebensdauer der LED in Betriebsstunden	L90B10 >55.000h
Energieeffizienzklasse	E

LEUCHTE | PHOTOMETRISCHE DATEN

Leuchtenwirkungsgrad (LOR)	90%
Abstrahlwinkel	18°

LEUCHTE | ELEKTRISCHE DATEN

Driver	Inklusiv
Leistungswerte des Systems	12,25 W
Spannung	220V/240V
Frequenz	50/60 Hz
Helligkeitssteuerung	No Dim
Schutzklasse	⊕

ANDERE DATEN

Dichtigkeit	IP20
Wireless control	Bitte anfragen
Schwenkwinkel	90°
Drehwinkel	360°
Schientyp	Track 3L+N
Gewicht	610 g
Gewicht inkl. Verpackung	740 g
Abmessungen der Verpackung	325 x 135 x 96 mm
Stück pro Verpackung	1
Materialien	Aluminium / Polycarbonat



Fit ist ein Strahler für individuelle Einbauanwendungen, der in zwei Größen (Ø80 und Ø65) erhältlich ist. Die zylindrische Geometrie und die wesentlichen Formen zeichnen sich durch ästhetischen Minimalismus und Funktionalität aus, da sie in alle Richtungen ausgerichtet werden können. Durch die nach innen versetzte Optik und das in schwarz lackierte Innere des Tubus, erhöht sich die Blendungsbegrenzung exorbitant und kann durch die als Zubehör zu erhaltenen Lamellenklappen noch mehr eingegrenzt werden.

Polar-koordinaten diagramm

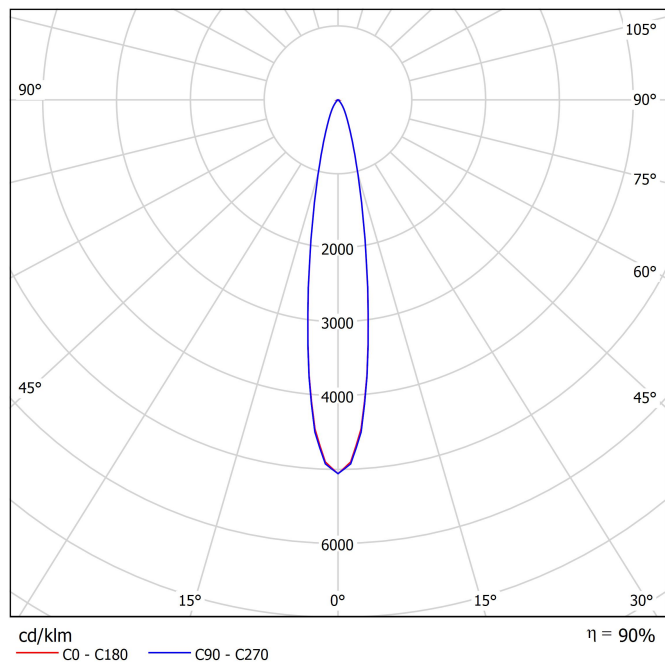

Kegeldiagramm

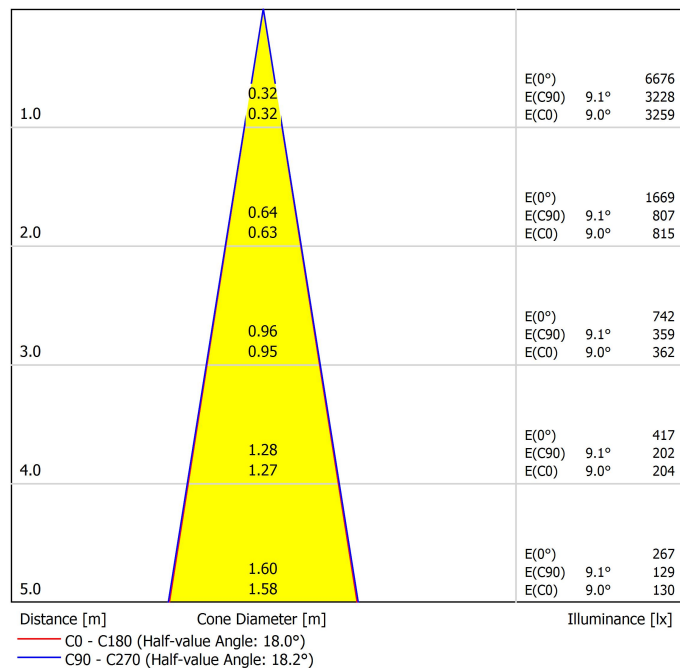



	PRODUCT
Model	Anti-glare Honeycomb Louver
Reference	A3560000
Category	Accessories

WIRD NICHT SEPARAT VERKAUFT. 

Blendschutz-Wabenraster

Zubehörteil mit einem wabenförmigen Raster, das den Lichtstrahl lenkt, Blendung reduziert und die direkte Sicht auf die Lichtquelle verhindert.

Track Options

Choose the track version required for your project configuration.

Surface & suspension

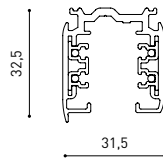

TRACK 3L 1m	A282-01-00- B N
TRACK 3L 2m	A282-02-00- B N
TRACK 3L 3m	A282-03-00- B N



Flush mounting*

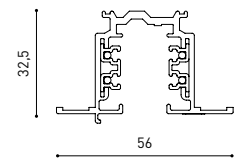

TRACK 3L FLUSH 1M	A282-11-00- B N
TRACK 3L FLUSH 2M	A282-12-00- B N
TRACK 3L FLUSH 3M	A282-13-00- B N

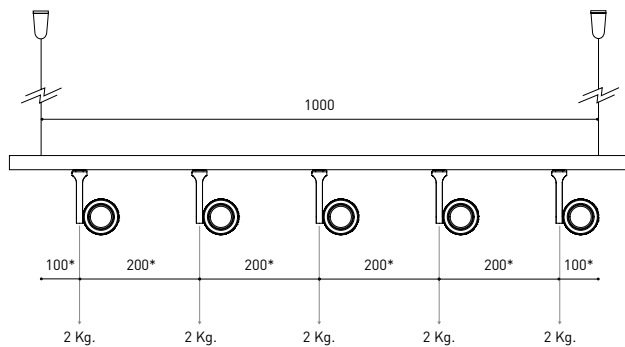

*minimum distance (mm.)

WEIGHT BEAR CAPACITY

Distancia de fijación y capacidad de carga.
Distancia de fijación recomendada l- 1000mm.

Fastening distance and loading capacity.
Recommended fastening distance l- 1000mm.

Distance de fixation et capacité de charge.
Distance de fixation recommandée l- 1000mm.

Distanza di installazione e capacità di carico.
Distanza consigliata di fissazione l- 1000mm.

Befestigungsabstand und Belastbarkeit.
Empfohlener Abstand l- 1000mm.

Alternative installation accessories

Fit Model: accessory only available in black finish

Six Model: accessories not available

TRACKLIGHT Recessed Adapter

0000-55-44- | W |

0000-55-40- | N |

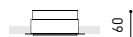

Ø130

TRACKLIGHT Surface Adapter

0000-55-43- | W |

0000-55-39- | N |









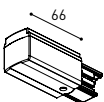

Ø100

COLOUR | B □ RAL 9016 | N ■ RAL 9005 |

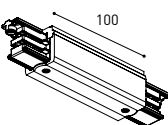

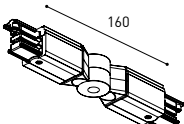
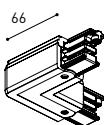

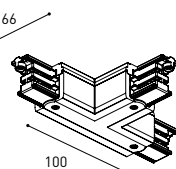

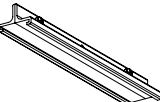
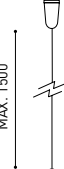

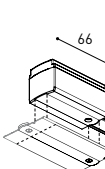

Complementary track accessories

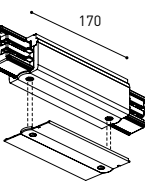
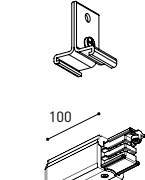
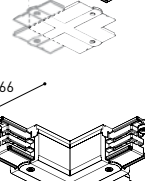
Use end caps and joiners to connect, close, and finish your track setup.

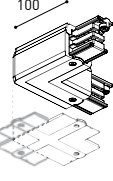

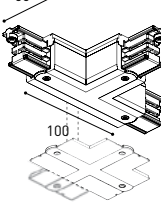
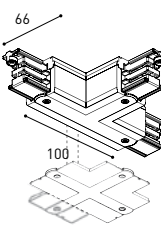
Surface & suspension

	POLARITY GROOVE	TRACK 3L Live-End Connector
		A282-00-01- B N
		A282-00-02- B N
		TRACK 3L Central Connector
		A282-00-03- B N
		TRACK 3L Ceiling Kit
		A219-21-06- B N
		TRACK 3L Universal Angle
		A282-00-15- B N
		TRACK 3L 90° Angle
		A282-00-06- B N
		A282-00-07- B N
		TRACK 3L T Joint
		A282-00-16- B N
		A282-00-17- B N
		TRACK 3L Mechanical Joint
		A219-21-11- B N
		TRACK 3L Suspension Kit
		A219-21-10- B N
		At least 2 units needed

Flush mounting

	POLARITY GROOVE	TRACK 3L Live-End Connector
		A282-00-01- B N
		A282-00-02- B N
		TRACK 3L FLUSH Cover Plate
		A282-10-19- B N
		Mandatory for installation
		TRACK 3L Central Connector
		A282-00-03- B N
		TRACK 3L FLUSH Cover Plate
		A282-10-19- B N
		Mandatory for installation
		TRACK 3L FLUSH Ceiling Kit
		A219-22-06- B
		TRACK 3L 90° Angle
		A282-00-06- B N
		A282-00-07- B N
		TRACK 3L FLUSH Corner Cover Plate
		A282-10-20- B N
		Mandatory for installation
		TRACK 3L T Joint
		A282-00-16- B N
		A282-00-17- B N
		TRACK 3L FLUSH Corner Cover Plate
		A282-10-20- B N
		Mandatory for installation

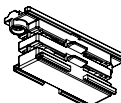
Surface, suspension & flush mounting

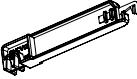
	TRACK Contact Joint
	A282-00-04- B N
	TRACK End
	A219-20-02- B N
	TRACK Clamp Kit for M6 ROD
	A219-21-21- B
	TRACK Bending Tool
	A282-00-00
	For tracks its length has been modified

COLOUR | B RAL 9016 | N RAL 9005 |



Fuente de luz (LED) reemplazable por un profesional autorizado

Replaceable (LED only) light source by an authorized professional.

Source lumineuse (LED) remplaçable par un professionnel agréé

Sorgente luminosa (LED) sostituibile da parte di un professionista autorizzato

Austauschbare (LED) Lichtquelle durch einen autorisierten Fachmann



Equipo de control reemplazable por un profesional autorizado

Replaceable control gear by an authorized professional

Dispositif de commande remplaçable par un professionnel agréé

Alimentatore sostituibile da parte di un professionista autorizzato

Auswechselbares Betriebsgerät durch autorisierten Fachmann

Instrucciones para el final de vida y la eliminación de los componentes:

Instructions on end-of-life and component disposal:

Instructions pour la gestion des composants en fin de vie et leur mise au rebut :

Istruzioni per il fine vita e lo smaltimento dei componenti:

Anweisungen zur entsorgung der Leuchtenkomponenten:



Interrumpir la alimentación del aparato
Cut the power supply to the luminaire
Couper l'alimentation du luminaire
Interrompere l'alimentazione dell'apparecchio
Stromversorgung der Leuchte unterbrechen



Quitar la(s) fuente(s) de luz para el desecho
Remove light source(s) for disposal
Retirer la (les) source(s) lumineuse(s) pour l'élimination
Rimuovere la/le sorgente/e di luce per lo smaltimento
Lichtquelle(n) zur Entsorgung entfernen



Quitar la batería para el desecho
Remove the battery for decommissioning
Retirer la batterie pour sa mise au rebut
Rimuovere la batteria per la dismissione
Die Batterie ordnungsgemäß entsorgen



Quitar el equipo de control para el desecho
Remove control gear for disposal
Retirer le dispositif de commande pour l'élimination
Rimuovere l'alimentatore per lo smaltimento
Betriebsgerät zur Entsorgung ausbauen



Enviar los materiales a un centro de recogida RAEE
Send the materials to a WEEE collection centre
Envoyer les matériaux dans une déchetterie DEEE
Inviare i materiali ad un centro di raccolta RAEE
Die Materialien in einem WEEE-Zentrum entsorgen

