

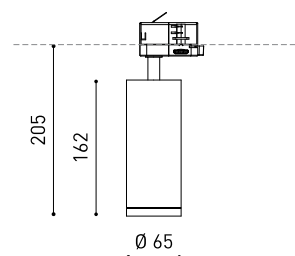

DIMENSIONS



ACCESSORIES



ANTI-GLARE HONEYCOMB
LOUVER



TRACK 3L OPTIONS

PRODUCT

| | |
|-----------|-------------------------------|
| Name | FIT 65 SPOT DIM DALI 3000K WT |
| Reference | A3560211WT |
| Color | Textured white |
| RAL | 9016 |
| Category | TRACK LIGHTS |

LIGHT SOURCE

| | |
|------------------------|------------------|
| Type | LED |
| Gross luminous flux | 1300 lm |
| Colour temperature | 3000 K |
| Chromatic stability | MacAdam Step 2 |
| Colour Rendering Index | CRI > 90 |
| Power | 10,3 W |
| Current | 300 mA |
| Efficacy | 126 lm/W |
| LED lifespan | L90B10 > 55.000h |

LIGHTING FIXTURE | PHOTOMETRIC DATA

| | |
|---------------------|-----|
| Lighting efficiency | 90% |
| Light beam angle | 18° |

LIGHTING FIXTURE | ELECTRICAL DATA

| | |
|-----------------------------|----------|
| Driver | Included |
| Power values of the system | 12,42 W |
| Frequency | 50/60 Hz |
| Dimming | DALI |
| Electrical insulation class | □ |

OTHER DATA

| | |
|----------------------|---------------------------|
| Sealing | IP20 |
| Wireless control | Please Consult |
| Swivel angle | 90° |
| Rotation angle | 360° |
| Track type | Track 3L+N Dimmable |
| Weight | 730 g |
| Packaged weight | 860 g |
| Packaging dimensions | 325 x 135 x 96 mm |
| Units per package | 1 |
| Materials | Aluminium / Polycarbonate |



Fit, is a spotlight for triphasic track applicatios available in two versions (Ø80 and Ø65). Cylindrical geometry and essential forms, it stands out for its minimalistic looking and its functionality as it can be orientated in any direction. The black perimeter around its mouth and its honeycomb accessory, highlights its anti-glare vocation.

POLAR DIAGRAM

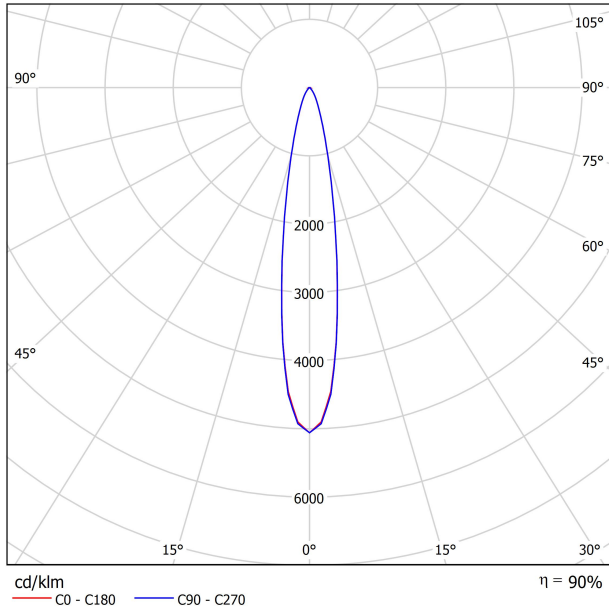

CONICAL DIAGRAM

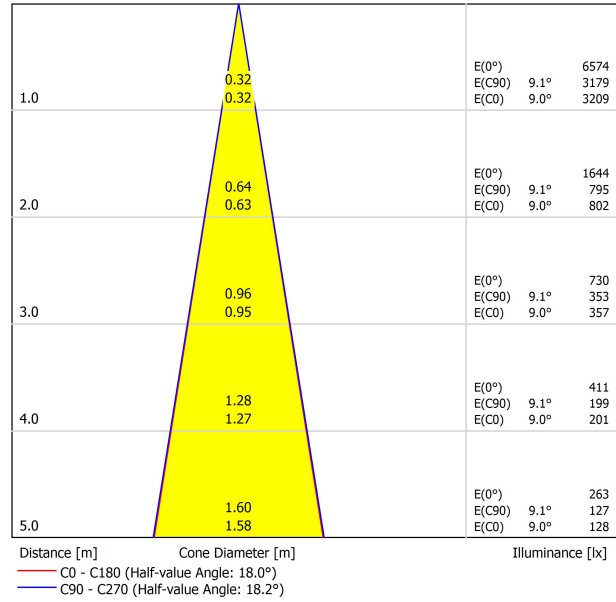



| | PRODUCT |
|-----------|-----------------------------|
| Model | Anti-glare Honeycomb Louver |
| Reference | A356-00-00 |
| Category | Accessories |

NOT SOLD SEPARATELY.



Accessory made up of louvers in the shape of a honeycomb panel to reduce glare and the effects of direct rays of vision.

TRACK 3L+N SURFACE & SUSPENDED

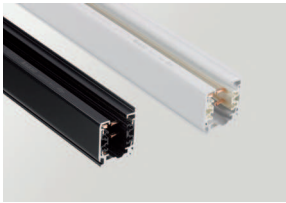

| | | | |
|-------------|-------------|---|---|
| TRACK 3L 1M | A219-21-01- | B | N |
| TRACK 3L 2M | A219-21-02- | B | N |
| TRACK 3L 3M | A219-21-03- | B | N |



TRACK 3L+N FLUSH MOUNTING

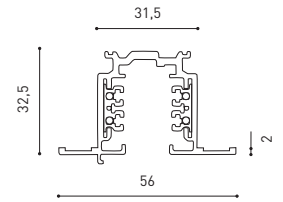
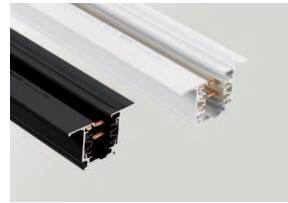

| | | | |
|-------------------|-------------|---|---|
| TRACK 3L FLUSH 1M | A219-22-01- | B | N |
| TRACK 3L FLUSH 2M | A219-22-02- | B | N |
| TRACK 3L FLUSH 3M | A219-22-03- | B | N |

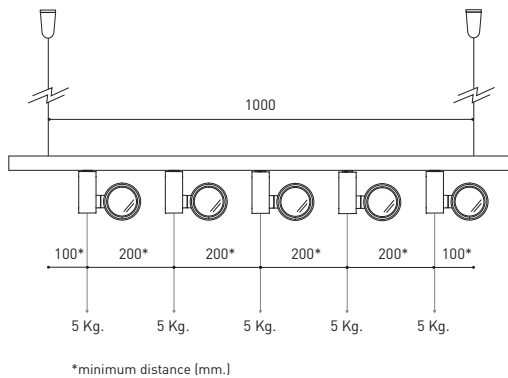

WEIGHT BEAR CAPACITY

Distancia de fijación y capacidad de carga.
Distancia de fijación recomendada l- 1000mm.

Fastening distance and loading capacity.
Recommended fastening distance l- 1000mm.

Distance de fixation et capacité de charge.
Distance de fixation recommandée l- 1000mm.

Distanza di installazione e capacità di carico.
Distanza consigliata di fissazione l- 1000mm.

Befestigungsabstand und Belastbarkeit.
Empfohlener Abstand l- 1000mm.

COLOUR | B □ RAL 9016 | N ■ RAL 9005 |

SURFACE & SUSPENDED

FLUSH MOUNTING



POLARITY GROOVE



TRACK 3L Live-End Connector

A219-21-04- | B | N |

A219-21-12- | B | N |



TRACK 3L Central Connector

A219-21-05- | B | N |



TRACK 3L Ceiling Kit

A219-21-06- | B | N |



TRACK 3L Universal Angle

A219-21-07- | B | N |



TRACK 3L 90° Angle

A219-21-08- | B | N |

A219-21-13- | B | N |

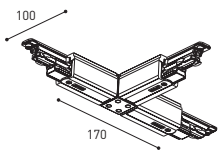

TRACK 3L T Joint

A219-21-09- | B | N |

A219-21-14- | B | N |



TRACK 3L Mechanical Joint

A219-21-11- | B | N |



TRACK 3L Suspension Kit

A219-21-10- | B | N |

At least 2 units needed

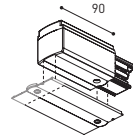

POLARITY GROOVE



TRACK 3L Live-End Connector

A219-21-04- | B | N |

A219-21-12- | B | N |



TRACK 3L FLUSH Cover Plate

A219-22-10- | B | N |

Mandatory for installation

TRACK 3L Central Connector

A219-21-05- | B | N |

TRACK 3L FLUSH Cover Plate

A219-22-10- | B | N |

Mandatory for installation



TRACK 3L FLUSH Ceiling Kit

A219-22-06- | B |

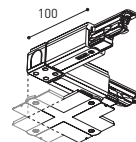

TRACK 3L 90° Angle

A219-21-08- | B | N |

A219-21-13- | B | N |

TRACK 3L FLUSH Corner Cover Plate

A219-22-11- | B | N |

Mandatory for installation



TRACK 3L T Joint

A219-21-09- | B | N |

A219-21-14- | B | N |

TRACK 3L FLUSH Corner Cover Plate

A219-22-11- | B | N |

Mandatory for installation

SURFACE & SUSP. / FLUSH MOUNTING

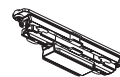

TRACK Contact Joint

A219-20-01- | B | N |



TRACK End

A219-20-02- | B | N |



TRACK Clamp Kit for M6 ROD

A219-21-21- | B |



TRACK Bending Tool

A282-00-00

For tracks its length has been modified

COLOUR | B □ RAL 9016 | N ■ RAL 9005 |



Fuente de luz (LED) reemplazable por un profesional autorizado

Replaceable (LED only) light source by an authorized professional.

Source lumineuse (LED) remplaçable par un professionnel agréé

Sorgente luminosa (LED) sostituibile da parte di un professionista autorizzato

Austauschbare (LED) Lichtquelle durch einen autorisierten Fachmann



Equipo de control reemplazable por un profesional autorizado

Replaceable control gear by an authorized professional

Dispositif de commande remplaçable par un professionnel agréé

Alimentatore sostituibile da parte di un professionista autorizzato

Auswechselbares Betriebsgerät durch autorisierten Fachmann

INSTRUCCIONES PARA EL FINAL DE VIDA Y LA ELIMINACIÓN LOS COMPONENTES
 INSTRUCTIONS ON END-OF-LIFE AND COMPONENT DISPOSAL
 INSTRUCTIONS POUR LA GESTION DES COMPOSANTS EN FIN DE VIE ET LEUR MISE AU REBUT
 ISTRUZIONI PER IL FINE VITA E LO SMALTIMENTO DEI COMPONENTI
 ANWEISUNGEN ZUR ENTSORGUNG DER LEUCHTENKOMPONENTEN



Interrumpir la alimentación del aparato
 Cut the power supply to the luminaire
 Couper l'alimentation du luminaire
 Interrompere l'alimentazione dell'apparecchio
 Stromversorgung der Leuchte unterbrechen



Quitar la(s) fuente(s) de luz para el desecho
 Remove light source(s) for disposal
 Retirer la (les) source(s) lumineuse(s) pour l'élimination
 Rimuovere la/le sorgente/e di luce per lo smaltimento
 Lichtquelle(n) zur Entsorgung entfernen



Quitar la batería para el desecho
 Remove the battery for decommissioning
 Retirer la batterie pour sa mise au rebut
 Rimuovere la batteria per la dismissione
 Die Batterie ordnungsgemäß entsorgen



Quitar el equipo de control para el desecho
 Remove control gear for disposal
 Retirer le dispositif de commande pour l'élimination
 Rimuovere l'alimentatore per lo smaltimento
 Betriebsgerät zur Entsorgung ausbauen



Enviar los materiales a un centro de recogida RAEE
 Send the materials to a WEEE collection centre
 Envoyer les matériaux dans une déchetterie DEEE
 Inviare i materiali ad un centro di raccolta RAEE
 Die Materialien in einem WEEE-Zentrum entsorgen

