

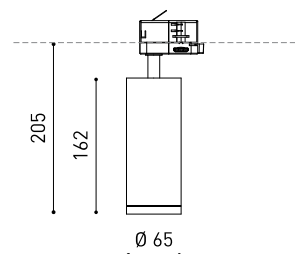

GRÖÖE



ZUBEHÖR

ANTI-GLÄRE HONEYCOMB
LOUVER

TRACK 3L OPTIONS

Name	FIT 65 MEDIUM DIM DALI 4000K WT
Artikelnummer	A3560222WT
Farbe	Weiß strukturiert
RAL	9016
Kategorie	TRACK LIGHTS

PRODUKT

Typ	LED
Bruttolichtstrom	1320 lm
Farbtemperatur	4000 K
Farbstabilität	MacAdam Step 2
Farbwiedergabeindex	CRI > 90
Leistung	10,3 W
Stromstärke	300 mA
Lichtausbeute	128 lm/W
Nutzlebensdauer der LED in Betriebsstunden	L90B10 > 55.000h

LICHTQUELLE

Leuchtenwirkungsgrad (LOR)	88%
Abstrahlwinkel	26°

LEUCHTE | PHOTOMETRISCHE DATEN

Driver	Inklusiv
Leistungswerte des Systems	12,42 W
Spannung	220V/240V
Frequenz	50/60 Hz
Helligkeitssteuerung	DALI
Schutzklasse	□

LEUCHTE | ELEKTRISCHE DATEN

Dichtigkeit	IP20
Wireless control	Bitte anfragen
Schwenkwinkel	90°
Drehwinkel	360°
Schienentyp	Track 3L+N Dimmable
Gewicht	730 g
Gewicht inkl. Verpackung	860 g
Abmessungen der Verpackung	325 x 135 x 96 mm
Stück pro Verpackung	1
Materialien	Aluminium / Polycarbonat

ANDERE DATEN



Fit ist ein Strahler für individuelle Einbauanwendungen, der in zwei Größen (Ø80 und Ø65) erhältlich ist. Die zylindrische Geometrie und die wesentlichen Formen zeichnen sich durch ästhetischen Minimalismus und Funktionalität aus, da sie in alle Richtungen ausgerichtet werden können. Durch die nach innen versetzte Optik und das in schwarz lackierte Innere des Tubus, erhöht sich die Blendungsbegrenzung exorbitant und kann durch die als Zubehör zu erhaltenen Lamellenklappen noch mehr eingegrenzt werden.

POLAR-KOORDINATEN DIAGRAMM

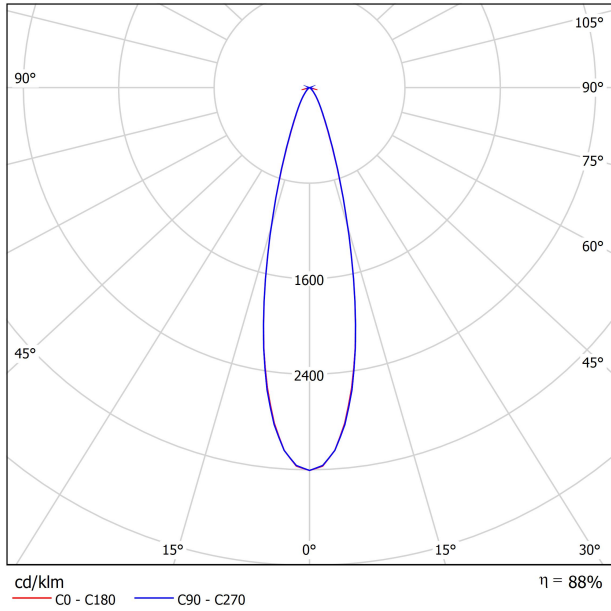

KEGELDIAGRAMM

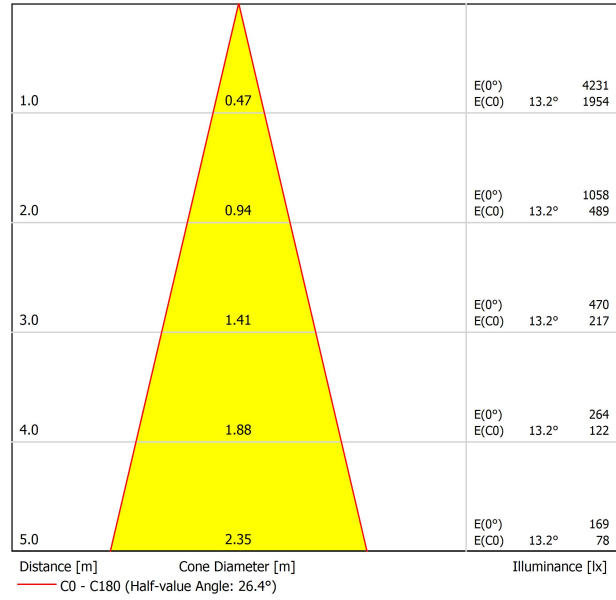



	PRODUCT
Model	Anti-glare Honeycomb Louver
Reference	A356-00-00
Category	Accessories

WIRD NICHT SEPARAT VERKAUFT.



Zubehör in Form eines Wabengitters, um die Blendung und den direkten Einfall der Strahlen in die Augen zu reduzieren.

TRACK 3L+N SURFACE & SUSPENDED

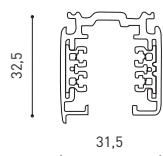

TRACK 3L 1M	A219-21-01-	B	N
TRACK 3L 2M	A219-21-02-	B	N
TRACK 3L 3M	A219-21-03-	B	N



TRACK 3L+N FLUSH MOUNTING

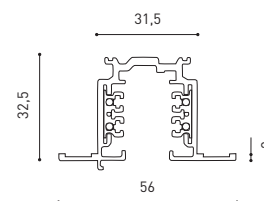
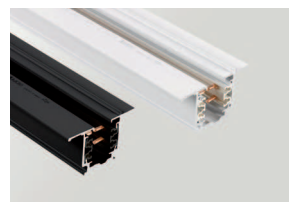

TRACK 3L FLUSH 1M	A219-22-01-	B	N
TRACK 3L FLUSH 2M	A219-22-02-	B	N
TRACK 3L FLUSH 3M	A219-22-03-	B	N

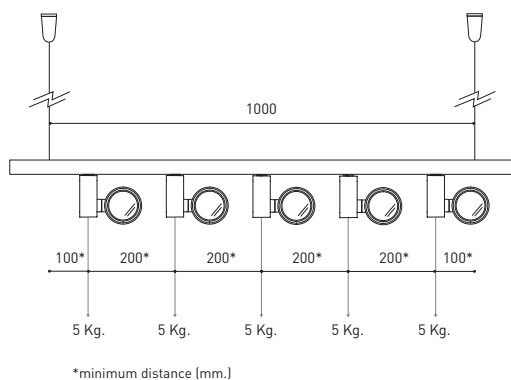

WEIGHT BEAR CAPACITY

Distancia de fijación y capacidad de carga.
Distancia de fijación recomendada l- 1000mm.

Fastening distance and loading capacity.
Recommended fastening distance l- 1000mm.

Distance de fixation et capacité de charge.
Distance de fixation recommandée l- 1000mm.

Distanza di installazione e capacità di carico.
Distanza consigliata di fissazione l- 1000mm.

Befestigungsabstand und Belastbarkeit.
Empfohlener Abstand l- 1000mm.

COLOUR | B □ RAL 9016 | N ■ RAL 9005 |

SURFACE & SUSPENDED

FLUSH MOUNTING

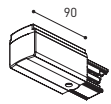

POLARITY GROOVE



TRACK 3L Live-End Connector

A219-21-04- | B | N |

A219-21-12- | B | N |

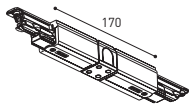

TRACK 3L Central Connector

A219-21-05- | B | N |



TRACK 3L Ceiling Kit

A219-21-06- | B | N |

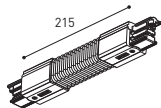

TRACK 3L Universal Angle

A219-21-07- | B | N |

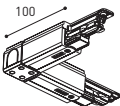

TRACK 3L 90° Angle

A219-21-08- | B | N |

A219-21-13- | B | N |

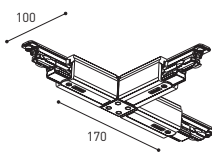

TRACK 3L T Joint

A219-21-09- | B | N |

A219-21-14- | B | N |

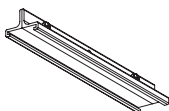

TRACK 3L Mechanical Joint

A219-21-11- | B | N |



TRACK 3L Suspension Kit

A219-21-10- | B | N |

At least 2 units needed

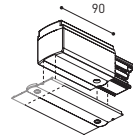

POLARITY GROOVE



TRACK 3L Live-End Connector

A219-21-04- | B | N |

A219-21-12- | B | N |

TRACK 3L FLUSH Cover Plate

A219-22-10- | B | N |

Mandatory for installation

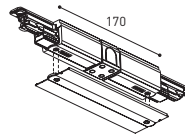

TRACK 3L Central Connector

A219-21-05- | B | N |

TRACK 3L FLUSH Cover Plate

A219-22-10- | B | N |

Mandatory for installation



TRACK 3L FLUSH Ceiling Kit

A219-22-06- | B |

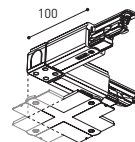

TRACK 3L 90° Angle

A219-21-08- | B | N |

A219-21-13- | B | N |

TRACK 3L FLUSH Corner Cover Plate

A219-22-11- | B | N |

Mandatory for installation

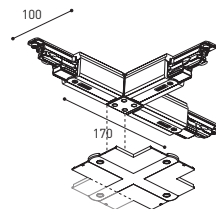

TRACK 3L T Joint

A219-21-09- | B | N |

A219-21-14- | B | N |

TRACK 3L FLUSH Corner Cover Plate

A219-22-11- | B | N |

Mandatory for installation

SURFACE & SUSP. / FLUSH MOUNTING

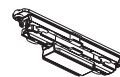

TRACK Contact Joint

A219-20-01- | B | N |



TRACK End

A219-20-02- | B | N |



TRACK Clamp Kit for M6 ROD

A219-21-21- | B |

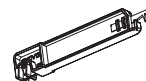

TRACK Bending Tool

A282-00-00

For tracks its length has been modified

COLOUR | B □ RAL 9016 | N ■ RAL 9005 |



Fuente de luz (LED) reemplazable por un profesional autorizado
 Replaceable (LED only) light source by an authorized professional.
 Source lumineuse (LED) remplaçable par un professionnel agréé
 Sorgente luminosa (LED) sostituibile da parte di un professionista autorizzato
 Austauschbare (LED) Lichtquelle durch einen autorisierten Fachmann



Equipo de control reemplazable por un profesional autorizado
 Replaceable control gear by an authorized professional
 Dispositif de commande remplaçable par un professionnel agréé
 Alimentatore sostituibile da parte di un professionista autorizzato
 Auswechselbares Betriebsgerät durch autorisierten Fachmann

INSTRUCCIONES PARA EL FINAL DE VIDA Y LA ELIMINACIÓN LOS COMPONENTES
 INSTRUCTIONS ON END-OF-LIFE AND COMPONENT DISPOSAL
 INSTRUCTIONS POUR LA GESTION DES COMPOSANTS EN FIN DE VIE ET LEUR MISE AU REBUT
 ISTRUZIONI PER IL FINE VITA E LO SMALTIMENTO DEI COMPONENTI
 ANWEISUNGEN ZUR ENTSORGUNG DER LEUCHTENKOMPONENTEN



Interrumpir la alimentación del aparato
 Cut the power supply to the luminaire
 Couper l'alimentation du luminaire
 Interrompere l'alimentazione dell'apparecchio
 Stromversorgung der Leuchte unterbrechen



Quitar la(s) fuente(s) de luz para el desecho
 Remove light source(s) for disposal
 Retirer la (les) source(s) lumineuse(s) pour l'élimination
 Rimuovere la/le sorgente/e di luce per lo smaltimento
 Lichtquelle(n) zur Entsorgung entfernen



Quitar la batería para el desecho
 Remove the battery for decommissioning
 Retirer la batterie pour sa mise au rebut
 Rimuovere la batteria per la dismissione
 Die Batterie ordnungsgemäß entsorgen



Quitar el equipo de control para el desecho
 Remove control gear for disposal
 Retirer le dispositif de commande pour l'élimination
 Rimuovere l'alimentatore per lo smaltimento
 Betriebsgerät zur Entsorgung ausbauen

Enviar los materiales a un centro de recogida RAEE
 Send the materials to a WEEE collection centre
 Envoyer les matériaux dans une déchetterie DEEE
 Inviare i materiali ad un centro di raccolta RAEE
 Die Materialien in einem WEEE-Zentrum entsorgen

