

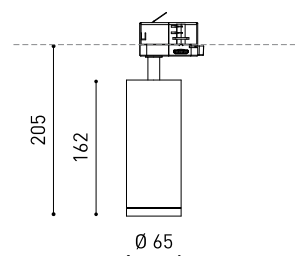

## DIMENSIONS



## ACCESSOIRES

ANTI-GLARE HONEYCOMB  
LOUVER

TRACK 3L OPTIONS

Nom	FIT 65 FLOOD DIM DALI 4000K WT
Référence	A3560232WT
Couleur	Blanc Texturé
RAL	9016
Catégorie	TRACK LIGHTS

Type	LED
Flux lumineux brut	1320 lm
Température de couleur	4000 K
Stabilité chromatique	MacAdam Step 2
Indice de reproduction chromatique	CRI > 90
Puissance	10,3 W
Courant	300 mA
Efficacité	128 lm/W
Durée de vie de la LED	L90B10 > 55.000h

Efficacité lumineuse	84%
Angle du faisceau lumineux	36°

Driver	Inclus
Valeurs de puissance du système	12,42 W
Tension	220V/240V
Fréquence	50/60 Hz
Variation d'intensité	DALI
Classe d'isolation électrique	<input type="checkbox"/>

Étanchéité	IP20
Contrôle sans fil	Veillez consulter
Angle d'inclinaison	90°
Angle de rotation	360°
Type de rail	Track 3L+N Dimmable
Poids	730 g
Poids avec emballage	860 g
Dimensions de l'emballage	325 x 135 x 96 mm
Unités par emballage	1
Matériaux	Aluminium / Polycarbonate



Fit est un projecteur pour applications de rails triphasées disponible en deux modèles Ø80 et Ø65). De géométrie cylindrique et de formes essentielles, il se distingue par son minimalisme esthétique et sa fonctionnalité, car il peut être orienté dans toutes les directions. Le périmètre de sa bouche en noir et son accessoire à grilles type panneau d'abeille qui accentuent sa vocation anti-éblouissante.

DIAGRAMME POLAIRE



DIAGRAMME CONIQUE



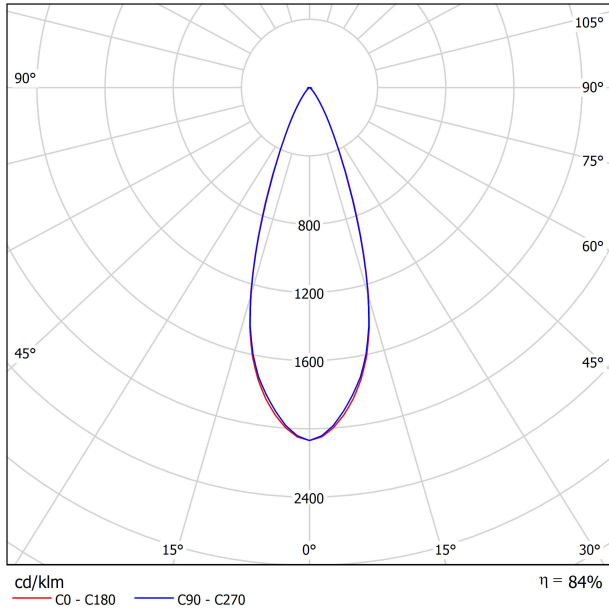
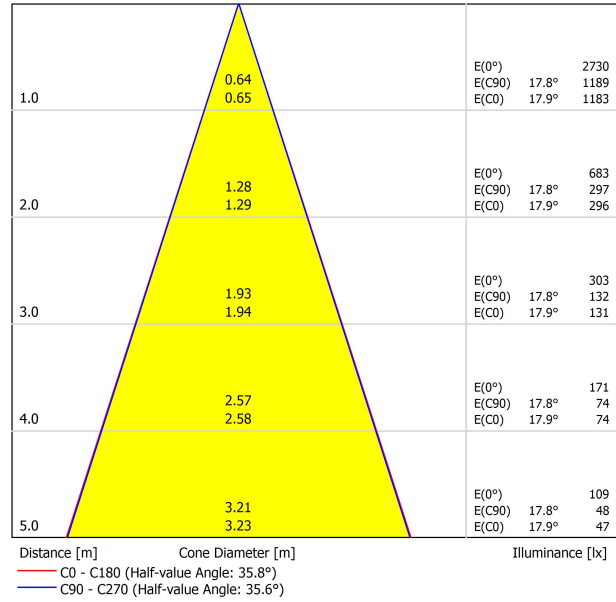

	PRODUCT
Model	Anti-glare Honeycomb Louver
Reference	A356-00-00
Category	Accessories

N'EST PAS VENDU SÉPARÉMENT.



Accessoire composé d'une grille en nid d'abeille pour réduire l'éblouissement et l'incidence directe des rayons dans la vision.

TRACK 3L+N SURFACE & SUSPENDED

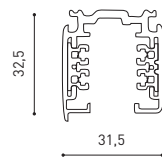

TRACK 3L 1M	A219-21-01-	B	N
TRACK 3L 2M	A219-21-02-	B	N
TRACK 3L 3M	A219-21-03-	B	N



TRACK 3L+N FLUSH MOUNTING

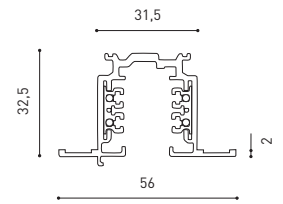

TRACK 3L FLUSH 1M	A219-22-01-	B	N
TRACK 3L FLUSH 2M	A219-22-02-	B	N
TRACK 3L FLUSH 3M	A219-22-03-	B	N

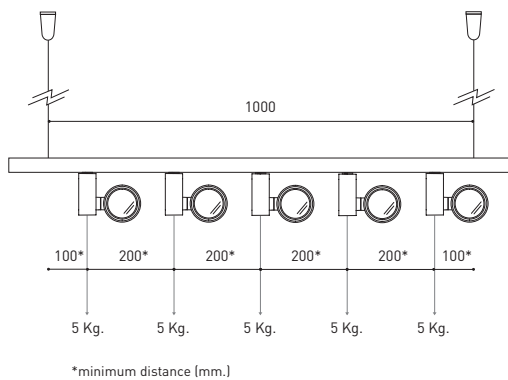

WEIGHT BEAR CAPACITY

Distancia de fijación y capacidad de carga.  
Distancia de fijación recomendada l- 1000mm.

Fastening distance and loading capacity.  
Recommended fastening distance l- 1000mm.

Distance de fixation et capacité de charge.  
Distance de fixation recommandée l- 1000mm.

Distanza di installazione e capacità di carico.  
Distanza consigliata di fissazione l- 1000mm.

Befestigungsabstand und Belastbarkeit.  
Empfohlener Abstand l- 1000mm.

COLOUR | B □ RAL 9016 | N ■ RAL 9005 |

## SURFACE & SUSPENDED

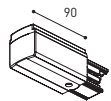

POLARITY GROOVE



**TRACK 3L Live-End Connector**

A219-21-04- | B | N |

A219-21-12- | B | N |

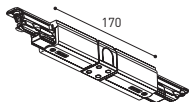

**TRACK 3L Central Connector**

A219-21-05- | B | N |



**TRACK 3L Ceiling Kit**

A219-21-06- | B | N |

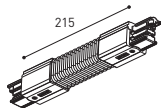

**TRACK 3L Universal Angle**

A219-21-07- | B | N |

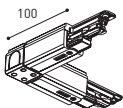

**TRACK 3L 90° Angle**

A219-21-08- | B | N |

A219-21-13- | B | N |

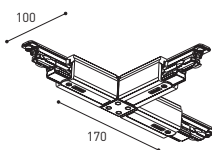

**TRACK 3L T Joint**

A219-21-09- | B | N |

A219-21-14- | B | N |

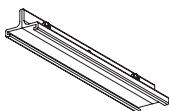

**TRACK 3L Mechanical Joint**

A219-21-11- | B | N |



**TRACK 3L Suspension Kit**

A219-21-10- | B | N |

At least 2 units needed

## FLUSH MOUNTING

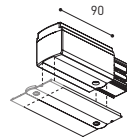

POLARITY GROOVE



**TRACK 3L Live-End Connector**

A219-21-04- | B | N |

A219-21-12- | B | N |

**TRACK 3L FLUSH Cover Plate**

A219-22-10- | B | N |

Mandatory for installation

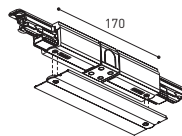

**TRACK 3L Central Connector**

A219-21-05- | B | N |

**TRACK 3L FLUSH Cover Plate**

A219-22-10- | B | N |

Mandatory for installation



**TRACK 3L FLUSH Ceiling Kit**

A219-22-06- | B |

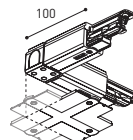

**TRACK 3L 90° Angle**

A219-21-08- | B | N |

A219-21-13- | B | N |

**TRACK 3L FLUSH Corner Cover Plate**

A219-22-11- | B | N |

Mandatory for installation

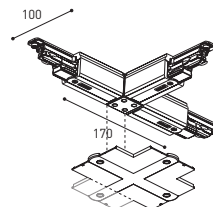

**TRACK 3L T Joint**

A219-21-09- | B | N |

A219-21-14- | B | N |

**TRACK 3L FLUSH Corner Cover Plate**

A219-22-11- | B | N |

Mandatory for installation

## SURFACE & SUSP. / FLUSH MOUNTING

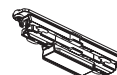

**TRACK Contact Joint**

A219-20-01- | B | N |



**TRACK End**

A219-20-02- | B | N |



**TRACK Clamp Kit for M6 ROD**

A219-21-21- | B |

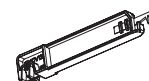

**TRACK Bending Tool**

A282-00-00

For tracks its length has been modified

COLOUR | B □ RAL 9016 | N ■ RAL 9005 |



Fuente de luz (LED) reemplazable por un profesional autorizado

Replaceable (LED only) light source by an authorized professional.

Source lumineuse (LED) remplaçable par un professionnel agréé

Sorgente luminosa (LED) sostituibile da parte di un professionista autorizzato

Austauschbare (LED) Lichtquelle durch einen autorisierten Fachmann



Equipo de control reemplazable por un profesional autorizado

Replaceable control gear by an authorized professional

Dispositif de commande remplaçable par un professionnel agréé

Alimentatore sostituibile da parte di un professionista autorizzato

Auswechselbares Betriebsgerät durch autorisierten Fachmann

INSTRUCCIONES PARA EL FINAL DE VIDA Y LA ELIMINACIÓN LOS COMPONENTES  
 INSTRUCTIONS ON END-OF-LIFE AND COMPONENT DISPOSAL  
 INSTRUCTIONS POUR LA GESTION DES COMPOSANTS EN FIN DE VIE ET LEUR MISE AU REBUT  
 ISTRUZIONI PER IL FINE VITA E LO SMALTIMENTO DEI COMPONENTI  
 ANWEISUNGEN ZUR ENTSORGUNG DER LEUCHTENKOMPONENTEN



Interrumpir la alimentación del aparato  
 Cut the power supply to the luminaire  
 Couper l'alimentation du luminaire  
 Interrompere l'alimentazione dell'apparecchio  
 Stromversorgung der Leuchte unterbrechen



Quitar la(s) fuente(s) de luz para el desecho  
 Remove light source(s) for disposal  
 Retirer la (les) source(s) lumineuse(s) pour l'élimination  
 Rimuovere la/le sorgente/e di luce per lo smaltimento  
 Lichtquelle(n) zur Entsorgung entfernen



Quitar la batería para el desecho  
 Remove the battery for decommissioning  
 Retirer la batterie pour sa mise au rebut  
 Rimuovere la batteria per la dismissione  
 Die Batterie ordnungsgemäß entsorgen



Quitar el equipo de control para el desecho  
 Remove control gear for disposal  
 Retirer le dispositif de commande pour l'élimination  
 Rimuovere l'alimentatore per lo smaltimento  
 Betriebsgerät zur Entsorgung ausbauen



Enviar los materiales a un centro de recogida RAEE  
 Send the materials to a WEEE collection centre  
 Envoyer les matériaux dans une déchetterie DEEE  
 Inviare i materiali ad un centro di raccolta RAEE  
 Die Materialien in einem WEEE-Zentrum entsorgen

