

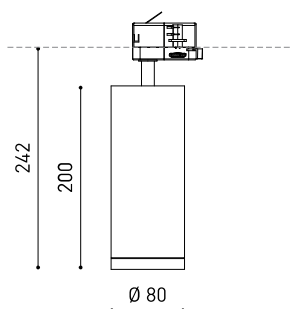

DIMENSIONS



ACCESSOIRES

ANTI-GLARE HONEYCOMB
LOUVER

TRACK 3L OPTIONS

Nom	FIT 80 SPOT DIM DALI 4000K WT
Référence	A3570212WT
Couleur	Blanc Texturé
RAL	9016
Catégorie	TRACK LIGHTS

PRODUIT

FIT 80 SPOT DIM DALI 4000K WT

A3570212WT

Blanc Texturé

9016

TRACK LIGHTS

SOURCE DE LUMIÈRE

LED

2540 lm

4000 K

MacAdam Step 2

CRI > 90

19 W

550 mA

134 lm/W

L90B10 > 55.000h

LUMINAIRE | DONNÉS PHOTOMÉTRIQUES

90%

19°

LUMINAIRE | DONNÉS ÉLECTRIQUES

Inclus

21,97 W

220V/240V

50/60 Hz

DALI



D'AUTRES DONNÉES

IP20

Veuillez consulter

90°

360°

Track 3L+N Dimmable

1030 g

1160 g

325 x 135 x 96 mm

1

Aluminium / Polycarbonate



Type	LED
Flux lumineux brut	2540 lm
Température de couleur	4000 K
Stabilité chromatique	MacAdam Step 2
Indice de reproduction chromatique	CRI > 90
Puissance	19 W
Courant	550 mA
Efficacité	134 lm/W
Durée de vie de la LED	L90B10 > 55.000h

Efficacité lumineuse	90%
Angle du faisceau lumineux	19°

Driver	Inclus
Valeurs de puissance du système	21,97 W
Tension	220V/240V
Fréquence	50/60 Hz
Variation d'intensité	DALI
Classe d'isolation électrique	⊕

Étanchéité	IP20
Contrôle sans fil	Veuillez consulter
Angle d'inclinaison	90°
Angle de rotation	360°
Type de rail	Track 3L+N Dimmable
Poids	1030 g
Poids avec emballage	1160 g
Dimensions de l'emballage	325 x 135 x 96 mm
Unités par emballage	1
Matériaux	Aluminium / Polycarbonate

Fit est un projecteur pour applications de rails triphasées disponible en deux modèles Ø80 et Ø65). De géométrie cylindrique et de formes essentielles, il se distingue par son minimalisme esthétique et sa fonctionnalité, car il peut être orienté dans toutes les directions. Le périmètre de sa bouche en noir et son accessoire à grilles type panneau d'abeille qui accentuent sa vocation anti-éblouissante.

DIAGRAMME POLAIRE



DIAGRAMME CONIQUE



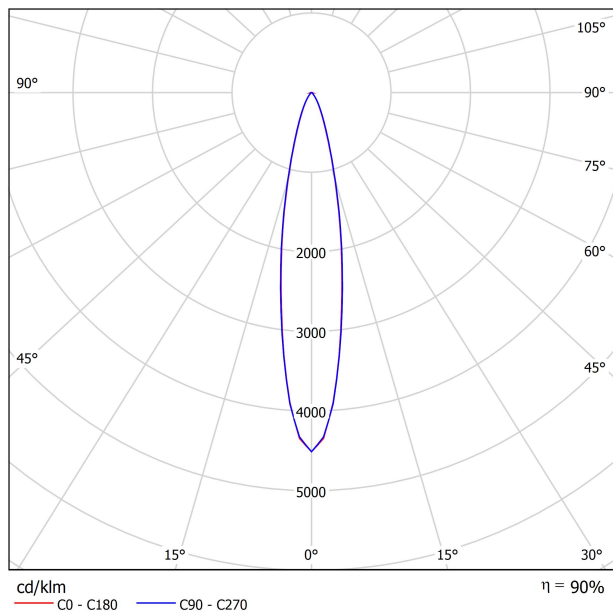
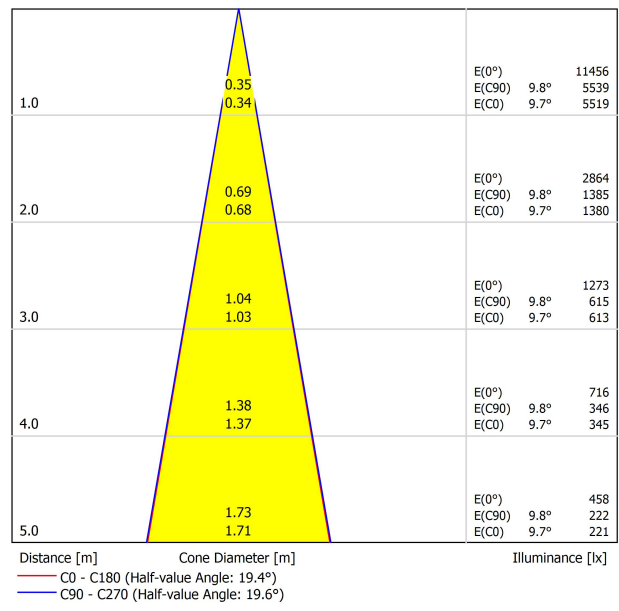

	PRODUCT
Model	Anti-glare Honeycomb Louver
Reference	A357-00-00
Category	Accessories

N'EST PAS VENDU SÉPARÉMENT.



Accessoire composé d'une grille en nid d'abeille pour réduire l'éblouissement et l'incidence directe des rayons dans la vision.

TRACK 3L+N SURFACE & SUSPENDED

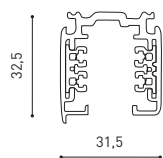

TRACK 3L 1M	A219-21-01-	B	N
TRACK 3L 2M	A219-21-02-	B	N
TRACK 3L 3M	A219-21-03-	B	N



TRACK 3L+N FLUSH MOUNTING

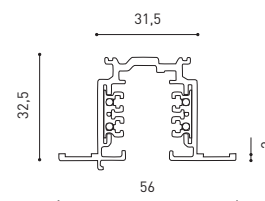
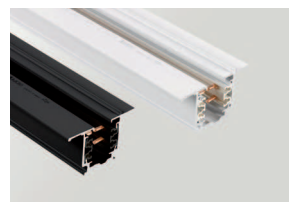

TRACK 3L FLUSH 1M	A219-22-01-	B	N
TRACK 3L FLUSH 2M	A219-22-02-	B	N
TRACK 3L FLUSH 3M	A219-22-03-	B	N

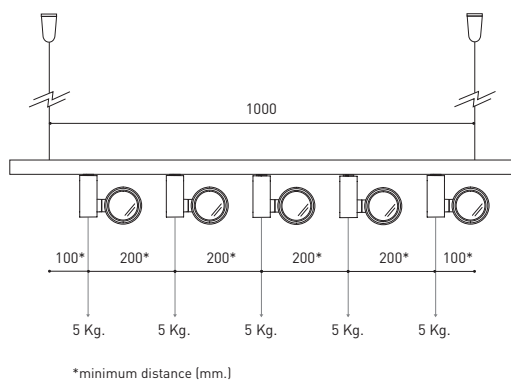

WEIGHT BEAR CAPACITY

Distancia de fijación y capacidad de carga.
Distancia de fijación recomendada l- 1000mm.

Fastening distance and loading capacity.
Recommended fastening distance l- 1000mm.

Distance de fixation et capacité de charge.
Distance de fixation recommandée l- 1000mm.

Distanza di installazione e capacità di carico.
Distanza consigliata di fissazione l- 1000mm.

Befestigungsabstand und Belastbarkeit.
Empfohlener Abstand l- 1000mm.

COLOUR | B □ RAL 9016 | N ■ RAL 9005 |

Calle N · Pol. Ind. EL OLIVERAL
46394 Ribarroja del Turia · Valencia (Spain)
Tel. +34 961 667 207 · Fax +34 961 667 054
info@arkoslight.com · www.arkoslight.com



SURFACE & SUSPENDED

FLUSH MOUNTING



POLARITY GROOVE



TRACK 3L Live-End Connector

A219-21-04- | B | N |

A219-21-12- | B | N |

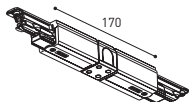

TRACK 3L Central Connector

A219-21-05- | B | N |



TRACK 3L Ceiling Kit

A219-21-06- | B | N |



TRACK 3L Universal Angle

A219-21-07- | B | N |



TRACK 3L 90° Angle

A219-21-08- | B | N |

A219-21-13- | B | N |

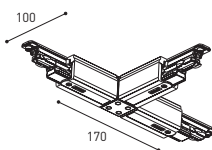

TRACK 3L T Joint

A219-21-09- | B | N |

A219-21-14- | B | N |

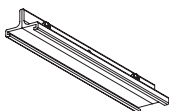

TRACK 3L Mechanical Joint

A219-21-11- | B | N |



TRACK 3L Suspension Kit

A219-21-10- | B | N |

At least 2 units needed

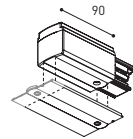

POLARITY GROOVE



TRACK 3L Live-End Connector

A219-21-04- | B | N |

A219-21-12- | B | N |

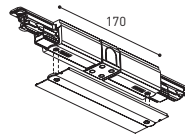

TRACK 3L FLUSH Cover Plate

A219-22-10- | B | N |

Mandatory for installation

TRACK 3L Central Connector

A219-21-05- | B | N |

TRACK 3L FLUSH Cover Plate

A219-22-10- | B | N |

Mandatory for installation



TRACK 3L FLUSH Ceiling Kit

A219-22-06- | B |

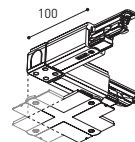

TRACK 3L 90° Angle

A219-21-08- | B | N |

A219-21-13- | B | N |

TRACK 3L FLUSH Corner Cover Plate

A219-22-11- | B | N |

Mandatory for installation

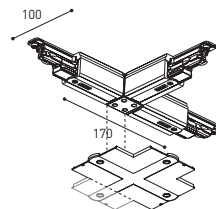

TRACK 3L T Joint

A219-21-09- | B | N |

A219-21-14- | B | N |

TRACK 3L FLUSH Corner Cover Plate

A219-22-11- | B | N |

Mandatory for installation

SURFACE & SUSP. / FLUSH MOUNTING

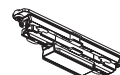

TRACK Contact Joint

A219-20-01- | B | N |



TRACK End

A219-20-02- | B | N |



TRACK Clamp Kit for M6 ROD

A219-21-21- | B |

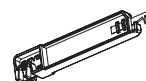

TRACK Bending Tool

A282-00-00

For tracks its length has been modified

COLOUR | B □ RAL 9016 | N ■ RAL 9005 |



Fuente de luz (LED) reemplazable por un profesional autorizado
 Replaceable (LED only) light source by an authorized professional.
 Source lumineuse (LED) remplaçable par un professionnel agréé
 Sorgente luminosa (LED) sostituibile da parte di un professionista autorizzato
 Austauschbare (LED) Lichtquelle durch einen autorisierten Fachmann



Equipo de control reemplazable por un profesional autorizado
 Replaceable control gear by an authorized professional
 Dispositif de commande remplaçable par un professionnel agréé
 Alimentatore sostituibile da parte di un professionista autorizzato
 Auswechselbares Betriebsgerät durch autorisierten Fachmann

INSTRUCCIONES PARA EL FINAL DE VIDA Y LA ELIMINACIÓN LOS COMPONENTES
 INSTRUCTIONS ON END-OF-LIFE AND COMPONENT DISPOSAL
 INSTRUCTIONS POUR LA GESTION DES COMPOSANTS EN FIN DE VIE ET LEUR MISE AU REBUT
 ISTRUZIONI PER IL FINE VITA E LO SMALTIMENTO DEI COMPONENTI
 ANWEISUNGEN ZUR ENTSORGUNG DER LEUCHTENKOMPONENTEN



Interrumpir la alimentación del aparato
 Cut the power supply to the luminaire
 Couper l'alimentation du luminaire
 Interrompere l'alimentazione dell'apparecchio
 Stromversorgung der Leuchte unterbrechen



Quitar la(s) fuente(s) de luz para el desecho
 Remove light source(s) for disposal
 Retirer la (les) source(s) lumineuse(s) pour l'élimination
 Rimuovere la/le sorgente/e di luce per lo smaltimento
 Lichtquelle(n) zur Entsorgung entfernen



Quitar la batería para el desecho
 Remove the battery for decommissioning
 Retirer la batterie pour sa mise au rebut
 Rimuovere la batteria per la dismissione
 Die Batterie ordnungsgemäß entsorgen



Quitar el equipo de control para el desecho
 Remove control gear for disposal
 Retirer le dispositif de commande pour l'élimination
 Rimuovere l'alimentatore per lo smaltimento
 Betriebsgerät zur Entsorgung ausbauen

Enviar los materiales a un centro de recogida RAEE
 Send the materials to a WEEE collection centre
 Envoyer les matériaux dans une déchetterie DEEE
 Inviare i materiali ad un centro di raccolta RAEE
 Die Materialien in einem WEEE-Zentrum entsorgen

