

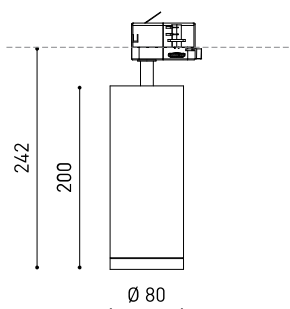

DIMENSIONES



ACCESORIOS



ANTI-GLARE HONEYCOMB
LOUVER



TRACK 3L OPTIONS

PRODUCTO

Nombre	FIT 80 MEDIUM DIM DALI 4000K NT
Referencia	A3570222NT
Color	Textured black
RAL	9005
Categoría	TRACKLIGHTS

FUENTE DE LUZ

Tipo	LED
Flujo Luminoso	2540 lm
Temperatura de color	4000 K
Estabilidad cromática	MacAdam Step 2
Índice de reproducción cromática	CRI > 90
Potencia	19 W
Corriente	550 mA
Eficacia	134 lm/W
Horas de Vida del LED	L90B10 > 55.000h

LUMINARIA | DATOS FOTOMÉTRICOS

Eficiencia Lumínica	84%
Ángulo del haz de luz	28°

LUMINARIA | DATOS ELÉCTRICOS

Driver	Included
Potencia del sistema	21,97 W
Tensión	220V/240V
Frecuencia	50/60 Hz
Regulación	DALI
Clase de seguridad eléctrica	⊕

OTROS DATOS

Estanqueidad	IP20
Control inalámbrico	Please Consult
Ángulo de basculación	90°
Ángulo de giro	360°
Tipo de carril	Track 3L+N Dimmable
Peso	1030 g
Peso con embalaje	1160 g
Dimensiones embalaje	325 x 135 x 96 mm
Unidades por embalaje	1
Materiales	Aluminium / Polycarbonate



Fit, is a spotlight for triphasic track applicatios available in two versions (Ø80 and Ø65). Cylindrical geometry and essential forms, it stands out for its minimalistic looking and its functionality as it can be orientated in any direction. The black perimeter around its mouth and its honeycomb accessory, highlights its anti-glare vocation.

DIAGRAMA POLAR



DIAGRAMA CÓNICO



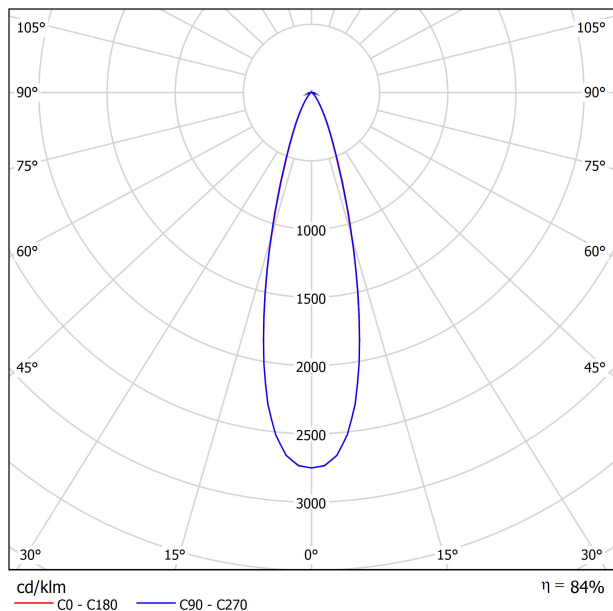
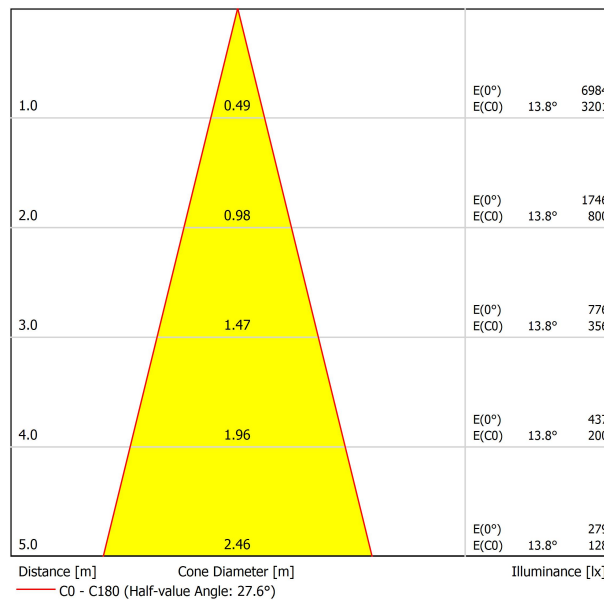

	PRODUCT
Model	Anti-glare Honeycomb Louver
Reference	A357-00-00
Category	Accessories

NOT SOLD SEPARATELY.



Accessory made up of louvre in the shape of a honeycomb panel to reduce glare and the effects of direct rays of vision.

TRACK 3L+N SURFACE & SUSPENDED

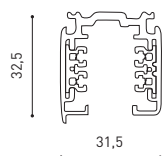

TRACK 3L 1M	A219-21-01-	B	N
TRACK 3L 2M	A219-21-02-	B	N
TRACK 3L 3M	A219-21-03-	B	N



TRACK 3L+N FLUSH MOUNTING

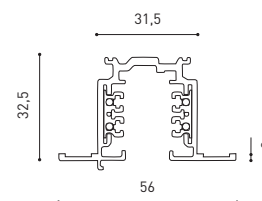
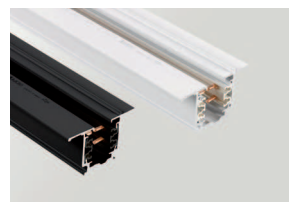

TRACK 3L FLUSH 1M	A219-22-01-	B	N
TRACK 3L FLUSH 2M	A219-22-02-	B	N
TRACK 3L FLUSH 3M	A219-22-03-	B	N

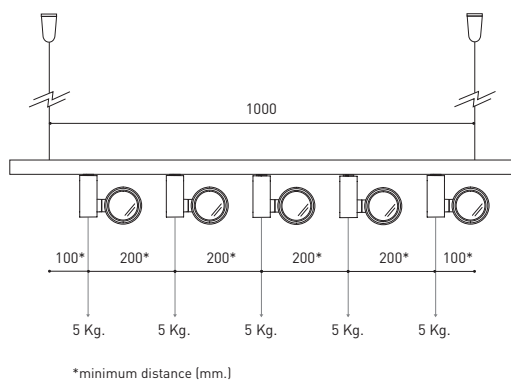

WEIGHT BEAR CAPACITY

Distancia de fijación y capacidad de carga.
Distancia de fijación recomendada l- 1000mm.

Fastening distance and loading capacity.
Recommended fastening distance l- 1000mm.

Distance de fixation et capacité de charge.
Distance de fixation recommandée l- 1000mm.

Distanza di installazione e capacità di carico.
Distanza consigliata di fissazione l- 1000mm.

Befestigungsabstand und Belastbarkeit.
Empfohlener Abstand l- 1000mm.

COLOUR | B □ RAL 9016 | N ■ RAL 9005 |

SURFACE & SUSPENDED

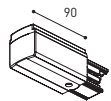

POLARITY GROOVE



TRACK 3L Live-End Connector

A219-21-04- | B | N |

A219-21-12- | B | N |

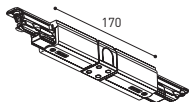

TRACK 3L Central Connector

A219-21-05- | B | N |



TRACK 3L Ceiling Kit

A219-21-06- | B | N |

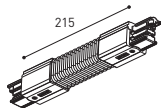

TRACK 3L Universal Angle

A219-21-07- | B | N |

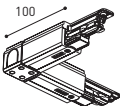

TRACK 3L 90° Angle

A219-21-08- | B | N |

A219-21-13- | B | N |

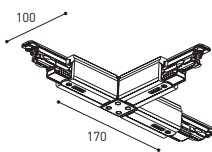

TRACK 3L T Joint

A219-21-09- | B | N |

A219-21-14- | B | N |

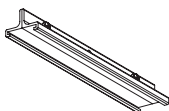

TRACK 3L Mechanical Joint

A219-21-11- | B | N |



TRACK 3L Suspension Kit

A219-21-10- | B | N |

At least 2 units needed

FLUSH MOUNTING

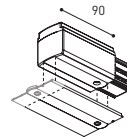

POLARITY GROOVE



TRACK 3L Live-End Connector

A219-21-04- | B | N |

A219-21-12- | B | N |

TRACK 3L FLUSH Cover Plate

A219-22-10- | B | N |

Mandatory for installation

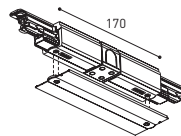

TRACK 3L Central Connector

A219-21-05- | B | N |

TRACK 3L FLUSH Cover Plate

A219-22-10- | B | N |

Mandatory for installation



TRACK 3L FLUSH Ceiling Kit

A219-22-06- | B |

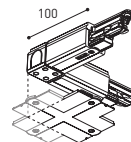

TRACK 3L 90° Angle

A219-21-08- | B | N |

A219-21-13- | B | N |



TRACK 3L FLUSH Corner Cover Plate

A219-22-11- | B | N |

Mandatory for installation

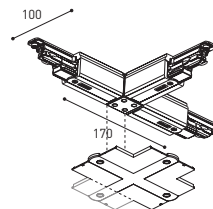

TRACK 3L T Joint

A219-21-09- | B | N |

A219-21-14- | B | N |



TRACK 3L FLUSH Corner Cover Plate

A219-22-11- | B | N |

Mandatory for installation

SURFACE & SUSP. / FLUSH MOUNTING

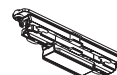

TRACK Contact Joint

A219-20-01- | B | N |



TRACK End

A219-20-02- | B | N |



TRACK Clamp Kit for M6 ROD

A219-21-21- | B |

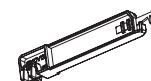

TRACK Bending Tool

A282-00-00

For tracks its length has been modified

COLOUR | B □ RAL 9016 | N ■ RAL 9005 |



Fuente de luz (LED) reemplazable por un profesional autorizado
 Replaceable (LED only) light source by an authorized professional.
 Source lumineuse (LED) remplaçable par un professionnel agréé
 Sorgente luminosa (LED) sostituibile da parte di un professionista autorizzato
 Austauschbare (LED) Lichtquelle durch einen autorisierten Fachmann



Equipo de control reemplazable por un profesional autorizado
 Replaceable control gear by an authorized professional
 Dispositif de commande remplaçable par un professionnel agréé
 Alimentatore sostituibile da parte di un professionista autorizzato
 Auswechselbares Betriebsgerät durch autorisierten Fachmann

INSTRUCCIONES PARA EL FINAL DE VIDA Y LA ELIMINACIÓN LOS COMPONENTES
 INSTRUCTIONS ON END-OF-LIFE AND COMPONENT DISPOSAL
 INSTRUCTIONS POUR LA GESTION DES COMPOSANTS EN FIN DE VIE ET LEUR MISE AU REBUT
 ISTRUZIONI PER IL FINE VITA E LO SMALTIMENTO DEI COMPONENTI
 ANWEISUNGEN ZUR ENTSORGUNG DER LEUCHTENKOMPONENTEN



Interrumpir la alimentación del aparato
 Cut the power supply to the luminaire
 Couper l'alimentation du luminaire
 Interrompere l'alimentazione dell'apparecchio
 Stromversorgung der Leuchte unterbrechen



Quitar la(s) fuente(s) de luz para el desecho
 Remove light source(s) for disposal
 Retirer la (les) source(s) lumineuse(s) pour l'élimination
 Rimuovere la/le sorgente/e di luce per lo smaltimento
 Lichtquelle(n) zur Entsorgung entfernen



Quitar la batería para el desecho
 Remove the battery for decommissioning
 Retirer la batterie pour sa mise au rebut
 Rimuovere la batteria per la dismissione
 Die Batterie ordnungsgemäß entsorgen



Quitar el equipo de control para el desecho
 Remove control gear for disposal
 Retirer le dispositif de commande pour l'élimination
 Rimuovere l'alimentatore per lo smaltimento
 Betriebsgerät zur Entsorgung ausbauen

Enviar los materiales a un centro de recogida RAEE
 Send the materials to a WEEE collection centre
 Envoyer les matériaux dans une déchetterie DEEE
 Inviare i materiali ad un centro di raccolta RAEE
 Die Materialien in einem WEEE-Zentrum entsorgen

