

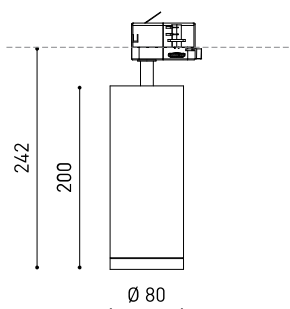

## DIMENSIONES



## ACCESORIOS

ANTI-GLARE HONEYCOMB  
LOUVER

TRACK 3L OPTIONS

|            |                                |
|------------|--------------------------------|
| Nombre     | FIT 80 FLOOD DIM DALI 3000K NT |
| Referencia | A3570231NT                     |
| Color      | Textured black                 |
| RAL        | 9005                           |
| Categoría  | TRACKLIGHTS                    |

## PRODUCTO

|                                  |                  |
|----------------------------------|------------------|
| Tipo                             | LED              |
| Flujo Luminoso                   | 2500 lm          |
| Temperatura de color             | 3000 K           |
| Estabilidad cromática            | MacAdam Step 2   |
| Índice de reproducción cromática | CRI > 90         |
| Potencia                         | 19 W             |
| Corriente                        | 550 mA           |
| Eficacia                         | 132 lm/W         |
| Horas de Vida del LED            | L90B10 > 55.000h |

## FUENTE DE LUZ

|                       |     |
|-----------------------|-----|
| Eficiencia Lumínica   | 85% |
| Ángulo del haz de luz | 37° |

## LUMINARIA | DATOS FOTOMÉTRICOS

|                              |           |
|------------------------------|-----------|
| Driver                       | Included  |
| Potencia del sistema         | 21,97 W   |
| Tensión                      | 220V/240V |
| Frecuencia                   | 50/60 Hz  |
| Regulación                   | DALI      |
| Clase de seguridad eléctrica | ⊕         |

## LUMINARIA | DATOS ELÉCTRICOS

|                       |                           |
|-----------------------|---------------------------|
| Estanqueidad          | IP20                      |
| Control inalámbrico   | Please Consult            |
| Ángulo de basculación | 90°                       |
| Ángulo de giro        | 360°                      |
| Tipo de carril        | Track 3L+N Dimmable       |
| Peso                  | 1030 g                    |
| Peso con embalaje     | 1160 g                    |
| Dimensiones embalaje  | 325 x 135 x 96 mm         |
| Unidades por embalaje | 1                         |
| Materiales            | Aluminium / Polycarbonate |

## OTROS DATOS



Fit, is a spotlight for triphasic track applicatios available in two versions (Ø80 and Ø65). Cylindrical geometry and essential forms, it stands out for its minimalistic looking and its functionality as it can be orientated in any direction. The black perimeter around its mouth and its honeycomb accessory, highlights its anti-glare vocation.

DIAGRAMA POLAR



DIAGRAMA CÓNICO



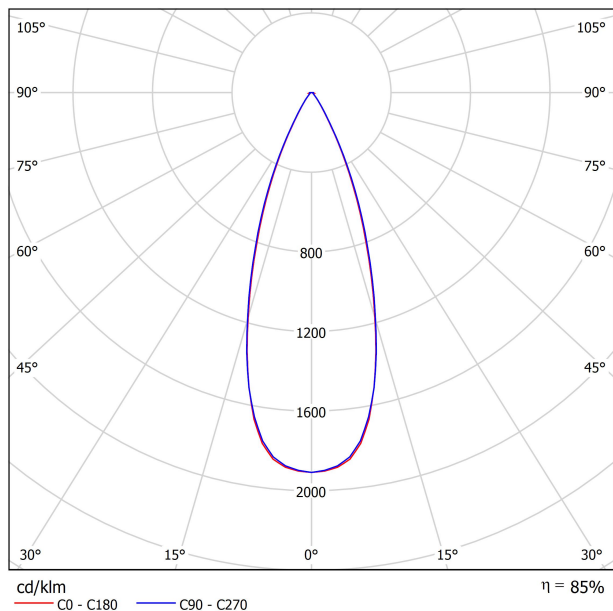
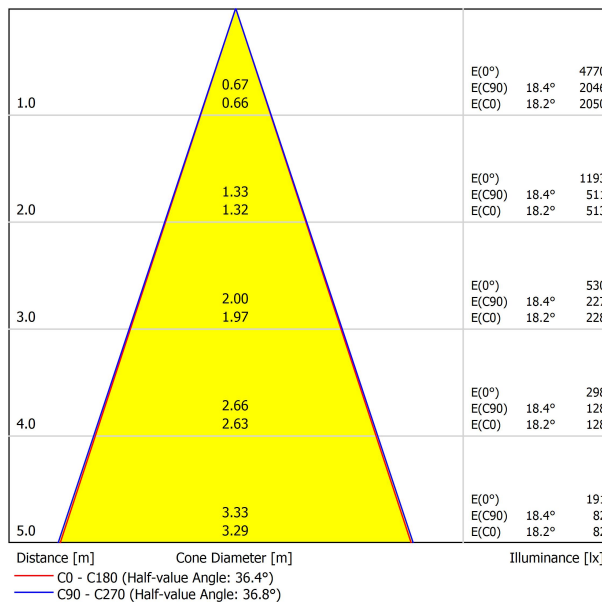

|           | PRODUCT                     |
|-----------|-----------------------------|
| Model     | Anti-glare Honeycomb Louver |
| Reference | A357-00-00                  |
| Category  | Accessories                 |

NOT SOLD SEPARATELY.



Accessory made up of louvre in the shape of a honeycomb panel to reduce glare and the effects of direct rays of vision.

TRACK 3L+N SURFACE & SUSPENDED

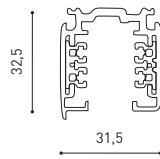

|             |             |   |   |
|-------------|-------------|---|---|
| TRACK 3L 1M | A219-21-01- | B | N |
| TRACK 3L 2M | A219-21-02- | B | N |
| TRACK 3L 3M | A219-21-03- | B | N |



TRACK 3L+N FLUSH MOUNTING

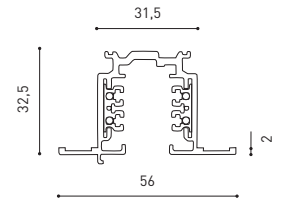
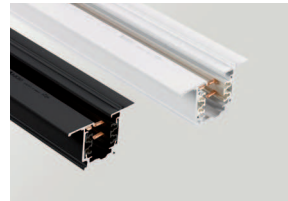

|                   |             |   |   |
|-------------------|-------------|---|---|
| TRACK 3L FLUSH 1M | A219-22-01- | B | N |
| TRACK 3L FLUSH 2M | A219-22-02- | B | N |
| TRACK 3L FLUSH 3M | A219-22-03- | B | N |

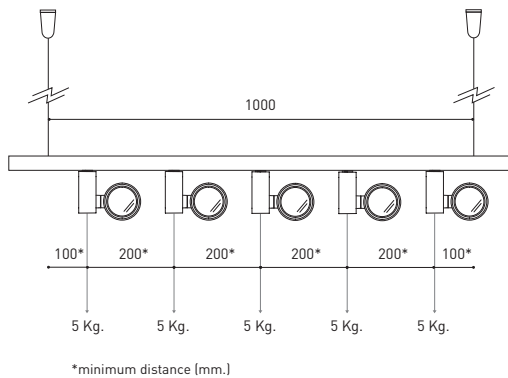

WEIGHT BEAR CAPACITY

Distancia de fijación y capacidad de carga.  
Distancia de fijación recomendada l- 1000mm.

Fastening distance and loading capacity.  
Recommended fastening distance l- 1000mm.

Distance de fixation et capacité de charge.  
Distance de fixation recommandée l- 1000mm.

Distanza di installazione e capacità di carico.  
Distanza consigliata di fissazione l- 1000mm.

Befestigungsabstand und Belastbarkeit.  
Empfohlener Abstand l- 1000mm.

COLOUR | B □ RAL 9016 | N ■ RAL 9005 |

Calle N · Pol. Ind. EL OLIVERAL  
46394 Ribarroja del Turia · Valencia (Spain)  
Tel. +34 961 667 207 · Fax +34 961 667 054  
info@arkoslight.com · www.arkoslight.com



## SURFACE & SUSPENDED

## FLUSH MOUNTING



POLARITY GROOVE



### TRACK 3L Live-End Connector

A219-21-04- | B | N |

A219-21-12- | B | N |

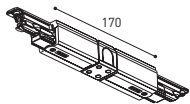

### TRACK 3L Central Connector

A219-21-05- | B | N |



### TRACK 3L Ceiling Kit

A219-21-06- | B | N |



### TRACK 3L Universal Angle

A219-21-07- | B | N |



### TRACK 3L 90° Angle

A219-21-08- | B | N |

A219-21-13- | B | N |

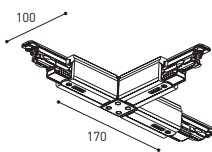

### TRACK 3L T Joint

A219-21-09- | B | N |

A219-21-14- | B | N |

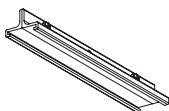

### TRACK 3L Mechanical Joint

A219-21-11- | B | N |



### TRACK 3L Suspension Kit

A219-21-10- | B | N |

At least 2 units needed

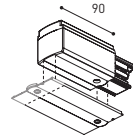

POLARITY GROOVE



### TRACK 3L Live-End Connector

A219-21-04- | B | N |

A219-21-12- | B | N |

### TRACK 3L FLUSH Cover Plate

A219-22-10- | B | N |

Mandatory for installation

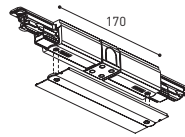

### TRACK 3L Central Connector

A219-21-05- | B | N |

### TRACK 3L FLUSH Cover Plate

A219-22-10- | B | N |

Mandatory for installation



### TRACK 3L FLUSH Ceiling Kit

A219-22-06- | B |

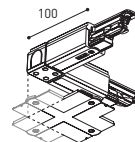

### TRACK 3L 90° Angle

A219-21-08- | B | N |

A219-21-13- | B | N |

### TRACK 3L FLUSH Corner Cover Plate

A219-22-11- | B | N |

Mandatory for installation

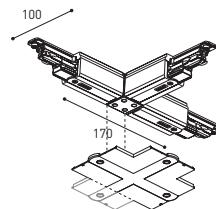

### TRACK 3L T Joint

A219-21-09- | B | N |

A219-21-14- | B | N |

### TRACK 3L FLUSH Corner Cover Plate

A219-22-11- | B | N |

Mandatory for installation

## SURFACE & SUSP. / FLUSH MOUNTING

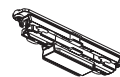

### TRACK Contact Joint

A219-20-01- | B | N |



### TRACK End

A219-20-02- | B | N |



### TRACK Clamp Kit for M6 ROD

A219-21-21- | B |

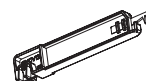

### TRACK Bending Tool

A282-00-00

For tracks its length has been modified

COLOUR | B □ RAL 9016 | N ■ RAL 9005 |



Fuente de luz (LED) reemplazable por un profesional autorizado

Replaceable (LED only) light source by an authorized professional.

Source lumineuse (LED) remplaçable par un professionnel agréé

Sorgente luminosa (LED) sostituibile da parte di un professionista autorizzato

Austauschbare (LED) Lichtquelle durch einen autorisierten Fachmann



Equipo de control reemplazable por un profesional autorizado

Replaceable control gear by an authorized professional

Dispositif de commande remplaçable par un professionnel agréé

Alimentatore sostituibile da parte di un professionista autorizzato

Auswechselbares Betriebsgerät durch autorisierten Fachmann

INSTRUCCIONES PARA EL FINAL DE VIDA Y LA ELIMINACIÓN LOS COMPONENTES  
 INSTRUCTIONS ON END-OF-LIFE AND COMPONENT DISPOSAL  
 INSTRUCTIONS POUR LA GESTION DES COMPOSANTS EN FIN DE VIE ET LEUR MISE AU REBUT  
 ISTRUZIONI PER IL FINE VITA E LO SMALTIMENTO DEI COMPONENTI  
 ANWEISUNGEN ZUR ENTSORGUNG DER LEUCHTENKOMPONENTEN



Interrumpir la alimentación del aparato  
 Cut the power supply to the luminaire  
 Couper l'alimentation du luminaire  
 Interrompere l'alimentazione dell'apparecchio  
 Stromversorgung der Leuchte unterbrechen



Quitar la(s) fuente(s) de luz para el desecho  
 Remove light source(s) for disposal  
 Retirer la (les) source(s) lumineuse(s) pour l'élimination  
 Rimuovere la/le sorgente/e di luce per lo smaltimento  
 Lichtquelle(n) zur Entsorgung entfernen



Quitar la batería para el desecho  
 Remove the battery for decommissioning  
 Retirer la batterie pour sa mise au rebut  
 Rimuovere la batteria per la dismissione  
 Die Batterie ordnungsgemäß entsorgen



Quitar el equipo de control para el desecho  
 Remove control gear for disposal  
 Retirer le dispositif de commande pour l'élimination  
 Rimuovere l'alimentatore per lo smaltimento  
 Betriebsgerät zur Entsorgung ausbauen



Enviar los materiales a un centro de recogida RAEE  
 Send the materials to a WEEE collection centre  
 Envoyer les matériaux dans une déchetterie DEEE  
 Inviare i materiali ad un centro di raccolta RAEE  
 Die Materialien in einem WEEE-Zentrum entsorgen

