



DIMENSIONS



ACCESSOIRES

ANTI-GLARE HONEYCOMB
LOUVER

TRACK 1L OPTIONS

Nom	FIT 65 1L FLOOD 4000K NT
Référence	A3660132NT
Couleur	Noir Texturé
RAL	9005
Catégorie	TRACK LIGHTS

PRODUIT

Type	LED
Flux lumineux brut	1320 lm
Température de couleur	4000 K
Stabilité chromatique	MacAdam Step 2
Indice de reproduction chromatique	CRI > 90
Puissance	10,3 W
Courant	300 mA
Efficacité	128 lm/W
Durée de vie de la LED	L80B10 > 60.000h

SOURCE DE LUMIÈRE

Efficacité lumineuse	84%
Angle du faisceau lumineux	36°

LUMINAIRE | DONNÉS PHOTOMÉTRIQUES

Driver	Inclus
Valeurs de puissance du système	12,25 W
Tension	220V/240V
Fréquence	50/60 Hz
Variation d'intensité	Non Dim
Classe d'isolation électrique	⊕

LUMINAIRE | DONNÉS ÉLECTRIQUES

Étanchéité	IP20
Angle d'inclinaison	90°
Angle de rotation	355°
Type de rail	Track 1L
Poids	575 g
Poids avec emballage	710 g
Dimensions de l'emballage	325 x 135 x 96 mm
Unités par emballage	1
Matériaux	Aluminium / Polycarbonate

D'AUTRES DONNÉES



Fit 65 1L est un projecteur destiné à un rail monophasé. De géométrie cylindrique et de formes essentielles, il se distingue par son minimalisme esthétique et sa fonctionnalité, car il peut être orienté dans toutes les directions. Le périmètre de sa bouche en noir et son accessoire à grilles type panneau d'abeille qui accentuent sa vocation anti-éblouissante.

DIAGRAMME POLAIRE



DIAGRAMME CONIQUE



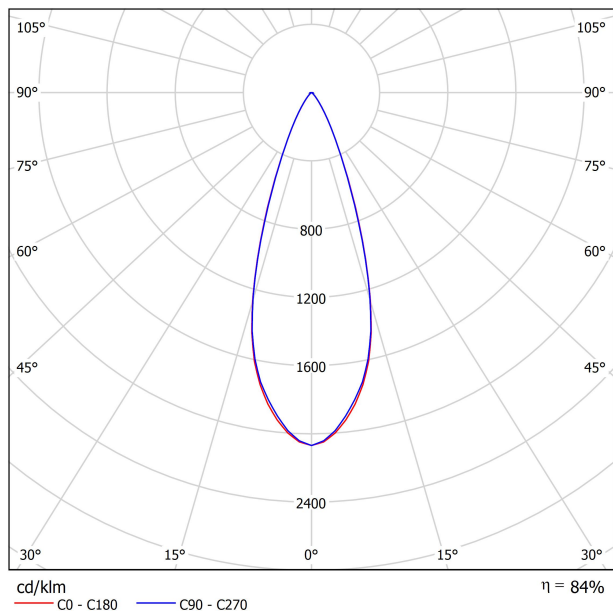
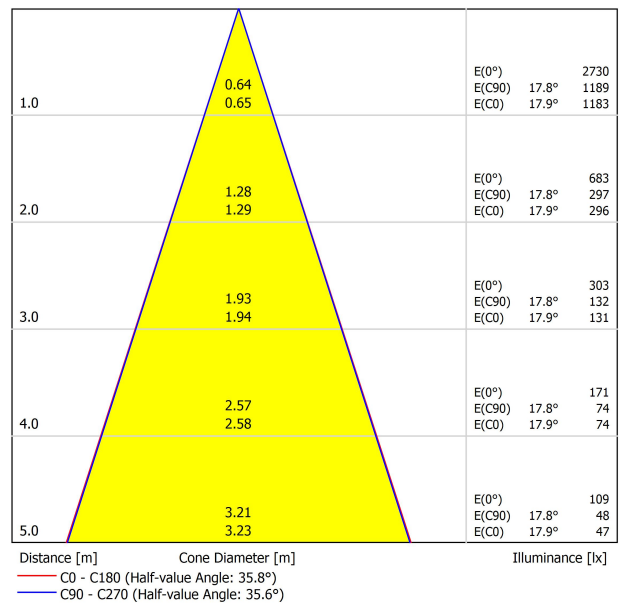

	PRODUCT
Model	Anti-glare Honeycomb Louver
Reference	A356-00-00
Category	Accessories

N'EST PAS VENDU SÉPARÉMENT. 

Accessoire composé d'une grille en nid d'abeille pour réduire l'éblouissement et l'incidence directe des rayons dans la vision.

SURFACE & SUSPENDED



TRACK 1L 1m	A264-01-00- B N
TRACK 1L 2m	A264-02-00- B N
TRACK 1L 3m	A264-03-00- B N



POLARITY GROOVE



	TRACK 1L Live-End Connector
	A264-00-01- B N
	A264-00-02- B N



	TRACK 1L Contact Joint
	A264-00-04- B N



	TRACK 1L Central Connector
	A264-00-03- B N



	TRACK 1L End
	A264-00-13- B N



	TRACK 1L 90° Angle
	A264-00-06- B N
	A264-00-07- B N

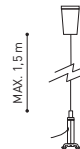

	TRACK 1L Suspension Kit
	A264-00-14- WT NT
	At least 2 units needed

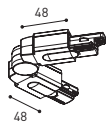

	TRACK 1L Corner connector
	A264-00-15- B N

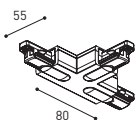

	TRACK 1L T-Joint
	A264-00-16- B N
	A264-00-17- B N

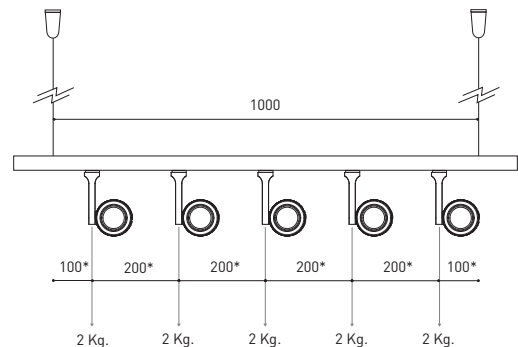

*minimum distance (mm.)

COLOUR | B □ RAL 9016 | N ■ RAL 9005 | WT □ RAL 9016 | NT ■ RAL 9005 |

FLUSH MOUNTING



TRACK 1L FLUSH 1m	A264-11-00- B N
TRACK 1L FLUSH 2m	A264-12-00- B N
TRACK 1L FLUSH 3m	A264-13-00- B N



POLARITY GROOVE



TRACK 1L FLUSH Live-End Connector

A264-00-01- B N
A264-00-02- B N

TRACK 1L FLUSH Cover Plate

A264-10-19- B N

Mandatory for installation



TRACK 1L FLUSH Central Connector

A264-00-03- B N

TRACK 1L FLUSH Corner Cover Plate

A264-10-20- B N

Mandatory for installation



TRACK 1L FLUSH 90° Angle

A264-00-06- B N
A264-00-07- B N

TRACK 1L FLUSH Corner Cover Plate

A264-10-20- B N

Mandatory for installation

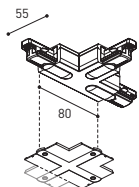

TRACK 1L FLUSH T-Joint

A264-00-16- B N
A264-00-17- B N

TRACK 1L FLUSH Corner Cover Plate

A264-10-20- B N

Mandatory for installation



TRACK 1L Contact Joint

A264-00-04- B N



TRACK 1L End

A264-00-13- B N



TRACK 1L FLUSH Suspension Kit

A264-10-15

For wire 1,5 mm [Not included]



*minimum distance [mm.]

COLOUR | B □ RAL 9016 | N ■ RAL 9005 |



Fuente de luz (LED) reemplazable por un profesional autorizado
 Replaceable (LED only) light source by an authorized professional.
 Source lumineuse (LED) remplaçable par un professionnel agréé
 Sorgente luminosa (LED) sostituibile da parte di un professionista autorizzato
 Austauschbare (LED) Lichtquelle durch einen autorisierten Fachmann



Equipo de control reemplazable por un profesional autorizado
 Replaceable control gear by an authorized professional
 Dispositif de commande remplaçable par un professionnel agréé
 Alimentatore sostituibile da parte di un professionista autorizzato
 Auswechselbares Betriebsgerät durch autorisierten Fachmann

INSTRUCCIONES PARA EL FINAL DE VIDA Y LA ELIMINACIÓN LOS COMPONENTES
 INSTRUCTIONS ON END-OF-LIFE AND COMPONENT DISPOSAL
 INSTRUCTIONS POUR LA GESTION DES COMPOSANTS EN FIN DE VIE ET LEUR MISE AU REBUT
 ISTRUZIONI PER IL FINE VITA E LO SMALTIMENTO DEI COMPONENTI
 ANWEISUNGEN ZUR ENTSORGUNG DER LEUCHTENKOMPONENTEN



Interrumpir la alimentación del aparato
 Cut the power supply to the luminaire
 Couper l'alimentation du luminaire
 Interrompere l'alimentazione dell'apparecchio
 Stromversorgung der Leuchte unterbrechen



Quitar la(s) fuente(s) de luz para el desecho
 Remove light source(s) for disposal
 Retirer la (les) source(s) lumineuse(s) pour l'élimination
 Rimuovere la/le sorgente/e di luce per lo smaltimento
 Lichtquelle(n) zur Entsorgung entfernen



Quitar la batería para el desecho
 Remove the battery for decommissioning
 Retirer la batterie pour sa mise au rebut
 Rimuovere la batteria per la dismissione
 Die Batterie ordnungsgemäß entsorgen



Quitar el equipo de control para el desecho
 Remove control gear for disposal
 Retirer le dispositif de commande pour l'élimination
 Rimuovere l'alimentatore per lo smaltimento
 Betriebsgerät zur Entsorgung ausbauen

Enviar los materiales a un centro de recogida RAEE
 Send the materials to a WEEE collection centre
 Envoyer les matériaux dans une déchetterie DEEE
 Inviare i materiali ad un centro di raccolta RAEE
 Die Materialien in einem WEEE-Zentrum entsorgen

