



GRÖÖE



ZUBEHÖR

ANTI-GLARE HONEYCOMB
LOUVER

TRACK 1L OPTIONS

Name	FIT 65 1L FLOOD 4000K WT
Artikelnummer	A3660132WT
Farbe	Weiß strukturiert
RAL	9016
Kategorie	TRACK LIGHTS

Typ	LED
Bruttolichtstrom	1320 lm
Farbtemperatur	4000 K
Farbstabilität	MacAdam Step 2
Farbwiedergabeindex	CRI > 90
Leistung	10,3 W
Stromstärke	300 mA
Lichtausbeute	128 lm/W
Nutzlebensdauer der LED in Betriebsstunden	L80B10 > 60.000h

Leuchtenwirkungsgrad (LOR)	84%
Abstrahlwinkel	36°

Driver	Inklusiv
Leistungswerte des Systems	12,25 W
Spannung	220V/240V
Frequenz	50/60 Hz
Helligkeitssteuerung	No Dim
Schutzklasse	⚡

Dichtigkeit	IP20
Schwenkwinkel	90°
Drehwinkel	355°
Schiennentyp	Track 1L
Gewicht	575 g
Gewicht inkl. Verpackung	710 g
Abmessungen der Verpackung	325 x 135 x 96 mm
Stück pro Verpackung	1
Materialien	Aluminium / Polycarbonat

PRODUKT

LICHTQUELLE

LEUCHTE | PHOTOMETRISCHE DATEN

LEUCHTE | ELEKTRISCHE DATEN

ANDERE DATEN



Fit 65 1L ist ein Strahler, der für eine einphasige Schiene gedacht ist. Die zylindrische Geometrie und die wesentlichen Formen zeichnen sich durch ästhetischen Minimalismus und Funktionalität aus, da sie in alle Richtungen ausgerichtet werden können. Durch die nach innen versetzte Optik und das in schwarz lackierte Innere des Tubus, erhöht sich die Blendungsbegrenzung exorbitant und kann durch die als Zubehör zu erhaltenen Lamellenklappen noch mehr eingegrenzt werden.

POLAR-KOORDINATEN DIAGRAMM

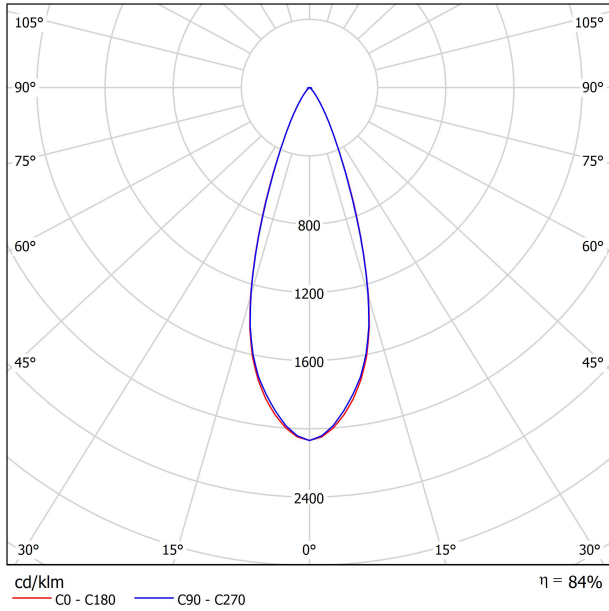

KEGELDIAGRAMM

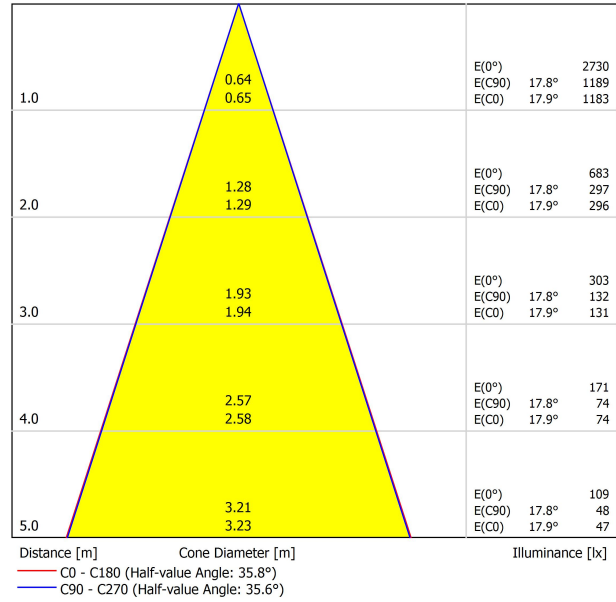



	PRODUCT
Model	Anti-glare Honeycomb Louver
Reference	A356-00-00
Category	Accessories

WIRD NICHT SEPARAT VERKAUFT.



Zubehör in Form eines Wabengitters, um die Blendung und den direkten Einfall der Strahlen in die Augen zu reduzieren.

SURFACE & SUSPENDED

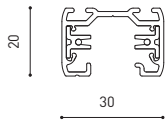
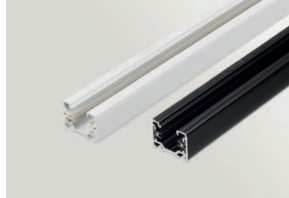

TRACK 1L 1m	A264-01-00- B N
TRACK 1L 2m	A264-02-00- B N
TRACK 1L 3m	A264-03-00- B N



POLARITY GROOVE



	TRACK 1L Live-End Connector
A264-00-01- B N	
	A264-00-02- B N



TRACK 1L Contact Joint
A264-00-04- B N



TRACK 1L Central Connector
A264-00-03- B N



TRACK 1L End
A264-00-13- B N

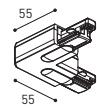

	TRACK 1L 90° Angle
A264-00-06- B N	
	A264-00-07- B N

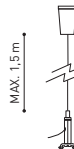

TRACK 1L Suspension Kit
A264-00-14- WT NT
At least 2 units needed

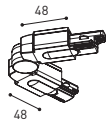

TRACK 1L Corner connector
A264-00-15- B N

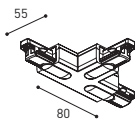

	TRACK 1L T-Joint
A264-00-16- B N	
	A264-00-17- B N

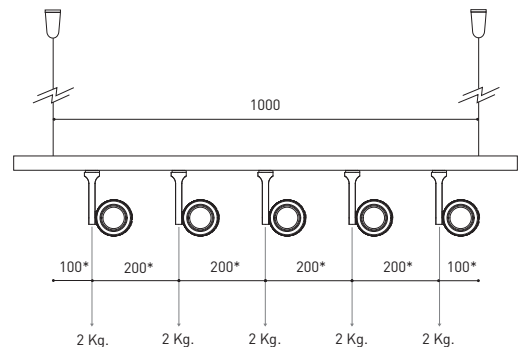

*minimum distance (mm.)

COLOUR | B □ RAL 9016 | N ■ RAL 9005 | WT □ RAL 9016 | NT ■ RAL 9005 |

FLUSH MOUNTING



TRACK 1L FLUSH 1m	A264-11-00- B N
TRACK 1L FLUSH 2m	A264-12-00- B N
TRACK 1L FLUSH 3m	A264-13-00- B N



POLARITY GROOVE



TRACK 1L FLUSH Live-End Connector

A264-00-01- B N
A264-00-02- B N

TRACK 1L FLUSH Cover Plate

A264-10-19- B N

Mandatory for installation



TRACK 1L FLUSH Central Connector

A264-00-03- B N

TRACK 1L FLUSH Corner Cover Plate

A264-10-20- B N

Mandatory for installation



TRACK 1L FLUSH 90° Angle

A264-00-06- B N
A264-00-07- B N

TRACK 1L FLUSH Corner Cover Plate

A264-10-20- B N

Mandatory for installation

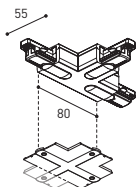

TRACK 1L FLUSH T-Joint

A264-00-16- B N
A264-00-17- B N

TRACK 1L FLUSH Corner Cover Plate

A264-10-20- B N

Mandatory for installation



TRACK 1L Contact Joint

A264-00-04- B N



TRACK 1L End

A264-00-13- B N



TRACK 1L FLUSH Suspension Kit

A264-10-15

For wire 1,5 mm [Not included]



*minimum distance [mm.]

COLOUR | B □ RAL 9016 | N ■ RAL 9005 |



Fuente de luz (LED) reemplazable por un profesional autorizado

Replaceable (LED only) light source by an authorized professional.

Source lumineuse (LED) remplaçable par un professionnel agréé

Sorgente luminosa (LED) sostituibile da parte di un professionista autorizzato

Austauschbare (LED) Lichtquelle durch einen autorisierten Fachmann



Equipo de control reemplazable por un profesional autorizado

Replaceable control gear by an authorized professional

Dispositif de commande remplaçable par un professionnel agréé

Alimentatore sostituibile da parte di un professionista autorizzato

Auswechselbares Betriebsgerät durch autorisierten Fachmann

INSTRUCCIONES PARA EL FINAL DE VIDA Y LA ELIMINACIÓN LOS COMPONENTES
 INSTRUCTIONS ON END-OF-LIFE AND COMPONENT DISPOSAL
 INSTRUCTIONS POUR LA GESTION DES COMPOSANTS EN FIN DE VIE ET LEUR MISE AU REBUT
 ISTRUZIONI PER IL FINE VITA E LO SMALTIMENTO DEI COMPONENTI
 ANWEISUNGEN ZUR ENTSORGUNG DER LEUCHTENKOMPONENTEN



Interrumpir la alimentación del aparato
 Cut the power supply to the luminaire
 Couper l'alimentation du luminaire
 Interrompere l'alimentazione dell'apparecchio
 Stromversorgung der Leuchte unterbrechen



Quitar la(s) fuente(s) de luz para el desecho
 Remove light source(s) for disposal
 Retirer la (les) source(s) lumineuse(s) pour l'élimination
 Rimuovere la/le sorgente/e di luce per lo smaltimento
 Lichtquelle(n) zur Entsorgung entfernen



Quitar la batería para el desecho
 Remove the battery for decommissioning
 Retirer la batterie pour sa mise au rebut
 Rimuovere la batteria per la dismissione
 Die Batterie ordnungsgemäß entsorgen



Quitar el equipo de control para el desecho
 Remove control gear for disposal
 Retirer le dispositif de commande pour l'élimination
 Rimuovere l'alimentatore per lo smaltimento
 Betriebsgerät zur Entsorgung ausbauen



Enviar los materiales a un centro de recogida RAEE
 Send the materials to a WEEE collection centre
 Envoyer les matériaux dans une déchetterie DEEE
 Inviare i materiali ad un centro di raccolta RAEE
 Die Materialien in einem WEEE-Zentrum entsorgen

