

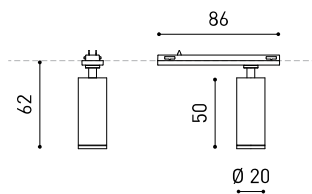

Dimensions



Accessories



MINIMAL TRACK OPTIONS

Awards



reddot winner 2020
innovative product
& lighting design



Bronze Delta
ADI Awards 2020



Name	FIT 20 24V FLOOD 3500K WT
Reference	A3860033WT
Colour	Textured white
RAL	9016
Category	TRACK LIGHTS

Type	LED
Gross luminous flux	160 lm
Colour temperature	3500 K
Chromatic stability	MacAdam Step 3
Colour Rendering Index	CRI>90
Power	2,1 W
Current	700 mA
Efficacy	76 lm/W
LED lifespan	L80B10 >50.000h
Energy efficiency class	G

Lighting efficiency	81%
Light beam angle	54°

Power values of the system	2,87 W
Dimming	DIM options
Electrical insulation class	⚡

Sealing	IP20
Wireless control	Please Consult
Swivel angle	90°
Rotation angle	355°
Track type	Minimal Track
Weight	45 g
Packaged weight	75 g
Packaging dimensions	112 x 90 x 26 mm
Units per package	1
Materials	Aluminium / Polycarbonate



Fit 20 24V is a projector for the Minimal Track system. Cylindrical geometry and essential forms, it stands out for its minimalistic looking and its functionality as it can be orientated in any direction. The black perimeter around its mouth highlights its anti-glare vocation.

Polar diagram

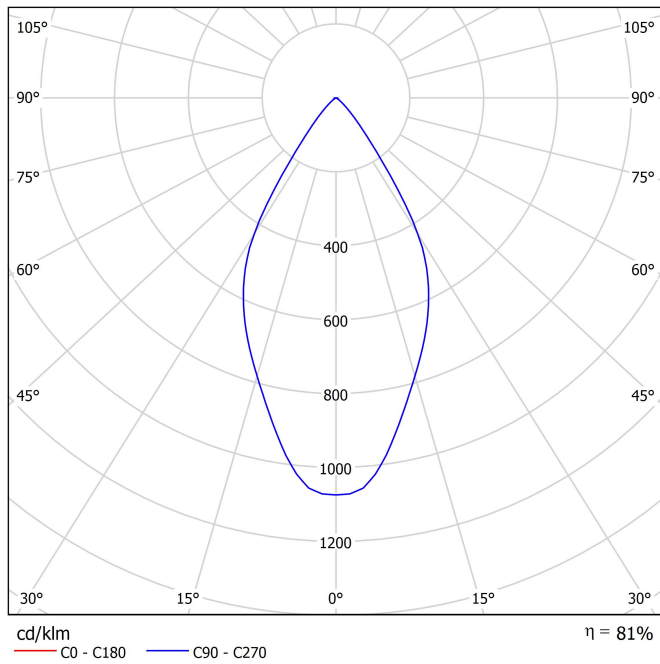

Conical diagram

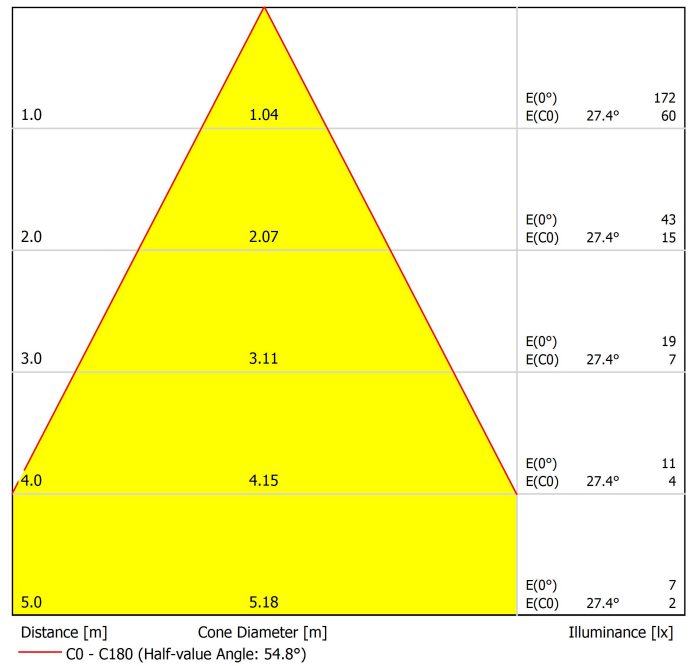

Installation guide



<https://youtu.be/KnedJbKp7oo>

Minimal Track

ARKOSLIGHT

Minimal Track is a 24V low-voltage lighting system designed to create minimalist and highly configurable installations. On this page, you'll find the necessary components to configure your surface-mounted system.



Or use our online configurator to design your own custom product layout. The tool will guide you through the process and automatically calculate the required drivers and accessories. [Start your configuration](#) →



Track & accessories - Surface mounting

Configure the shape of your track, add end caps and the required accessories, and finish the setup with the conductive strip (rubber cable).

MINIMAL TRACK 24V

Profile 2m

A384-02-00- | N | WT |

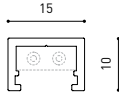

Corner 90° 1 Plane

A384-00-02- | N | WT |

Cable length = 35mm.

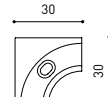

End Cap

A384-00-05- | N | WT |



Rubber Cable n x 1m

A384-00-01- | N |

n = Total length of System

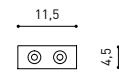

Corner 90° 1 Plane Rounded

A384-00-03- | N | WT |

Cable length = 35mm.

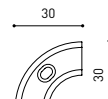

Connection Box

A384-00-06- | N | WT |

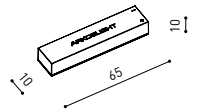

24V | Max. 4A |

Corner 90° 2 Planes

A384-00-04- | N | WT |

Cable length = 100mm.

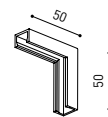

Power Supply

Select your power supply, include a dimmer if needed, and explore the installation diagrams provided.

		P	V	D (A x B x C)
MINIMAL TRACK 24V Power Supply Box	A384-00-07- NT WT	40W	24V	280 x 30 x 24mm
	A384-00-08- NT WT	100W	24V	280 x 30 x 24mm
MINIMAL TRACK 24V Remote Power Supply	0434-01-37	60W	24V	180 x 52 x 30mm
	0433-10-22	100W	24V	295 x 43 x 30mm
220 V ~ 240 V ~				
MINIMAL TRACK 24V Remote Constant Voltage Dimmer	0433-01-32	DALI / Push	24V	181 x 42 x 20mm
	0433-01-35	CASAMBI	24V	72,6 x 30 x 18mm
24V	other DIM options please consult			

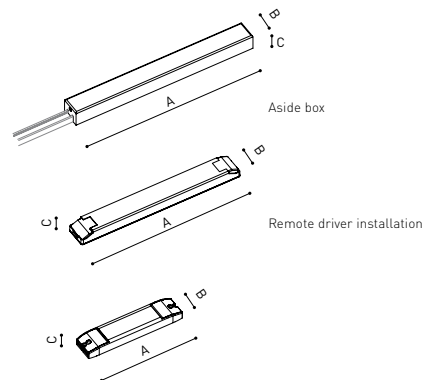

Connection diagram:

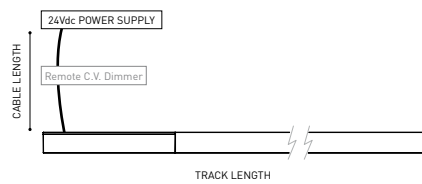

DROP VOLTAGE TABLE

POWER (W)	CABLE SECTION (mm ²)	CABLE LENGTH (m)			
		<5	<10	<20	<30
40	0,75	30	30	30	30
	1,5	30	30	30	30
60	0,75	30	30	20	10
	1,5	30	30	30	20
100	0,75	20	10	X	X
	1,5	20	20	10	X

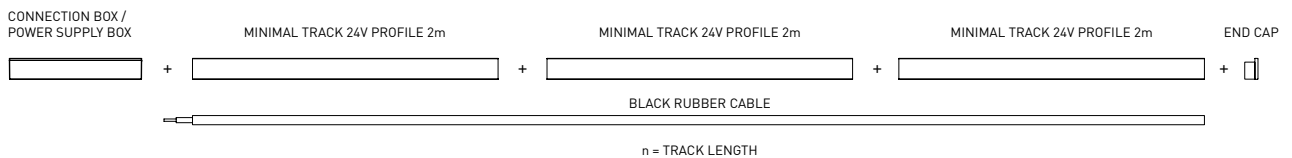

COLOUR | NT ■ RAL 9005 | WT □ RAL 9016 | N ■ RAL 9005 |

INSTALLATION GUIDE
<https://youtu.be/KnedJbKp7oo>



Minimal Track

ARKOSLIGHT

Minimal Track is a 24V low-voltage lighting system designed to create minimalist and highly configurable installations. On this page, you'll find the necessary components to configure your trimless-mounted system.



Or use our online configurator to design your own custom product layout. The tool will guide you through the process and automatically calculate the required drivers and accessories. [Start your configuration →](#)

Track & accessories - Trimless mounting

Configure the shape of your track, add end caps and the required accessories, and finish the setup with the conductive strip (rubber cable).

MINIMAL TRACK 24V

Trimless Profile 2m

A467-02-00- | N |

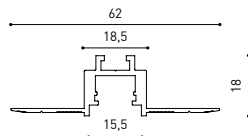

Trimless Rubber Cable n x 1m

A467-00-01- | N |

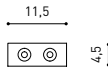

n = Total length of System

24V | Max. 4A |

Trimless Corner 90° 1 Plane

A467-00-02- | N |

Cable length = 140mm.

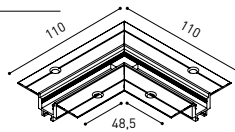

Trim. Corner 90° 1 Plane Connc.

A467-00-03- | N |



Trimless End Caps

A467-00-05- | N |

Two End Caps Included



Trimless Straight Joiner

A467-00-06

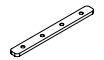

Trimless Connection Box

A467-00-07- | N |

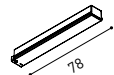

Power Supply

Select your power supply, include a dimmer if needed, and explore the installation diagrams provided.

		P	V	D (A x B x C)
MINIMAL TRACK 24V Remote Power Supply	0434-01-37	60W	24V	180 x 52 x 30mm
	0433-10-22	100W	24V	295 x 43 x 30mm

220 V ~
240

			V	D (A x B x C)
MINIMAL TRACK 24V Remote Constant Voltage Dimmer	0433-01-32	DALI / Push	24V	181 x 42 x 20mm
	0433-01-35	CASAMBI	24V	72,6 x 30 x 18mm

24V | other DIM options please consult

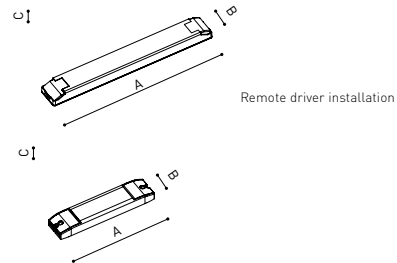

Connection diagram:

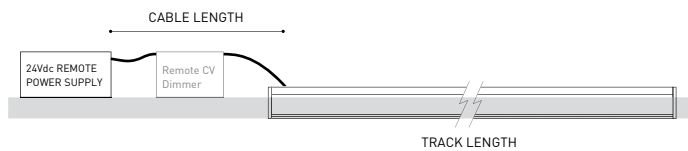

DROP VOLTAGE TABLE

POWER (W)	CABLE SECTION (mm ²)	CABLE LENGTH (m)			
		<5	<10	<20	<30
40	0,75	30	30	30	30
	1,5	30	30	30	30
60	0,75	30	30	20	10
	1,5	30	30	30	20
100	0,75	20	10	X	X
	1,5	20	20	10	X

Reduce 5 meters per each 'Corner 90° 1 Plane CONNECTOR' used.

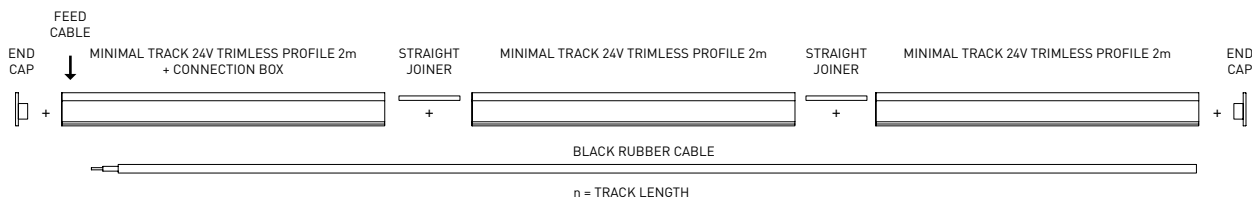

COLOUR | NT ■ RAL 9005 | WT □ RAL 9016 | N ■ RAL 9005 |

INSTALLATION GUIDE
<https://youtu.be/KnedJbKp7oo>



Minimal Track

ARKOSLIGHT

Minimal Track is a 24V low-voltage lighting system designed to create minimalist and highly configurable installations. On this page, you'll find the necessary components to configure your suspension-mounted system.



Or use our online configurator to design your own custom product layout. The tool will guide you through the process and automatically calculate the required drivers and accessories. [Start your configuration →](#)

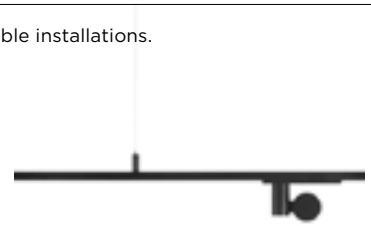

Track & accessories - Suspension mounting

Configure the shape of your track, add end caps and the required accessories, and finish the setup with the conductive strip (rubber cable).

MINIMAL TRACK 24V Suspension

Profile 2m

A384-02-00- | N | WT |

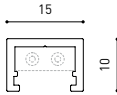

Rubber Cable n x 1m

A384-00-01- | N |

n = Total length of System

24V | Max. 4A | III

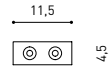

Suspension Straight Joiner

A400-00-02- | N | WT |

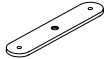

Profile 2m Initial feed kit

A400-02-10- | N | WT |

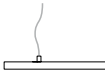

Suspension Kit

A400-02-04- | N | WT |

Max distance between suspension kits = 100 cm.

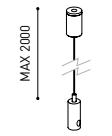

Profile 2m Middle feed kit*

A400-02-20- | N | WT |

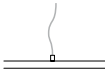

Corner 90°

A400-00-03- | N | WT |

Cable length = 85mm.

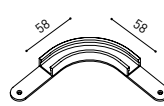

Suspension End Caps

A400-00-05- | N | WT |

Two End Caps Included.



* Unidirectional Middle Feed.

Power Supply

Select your power supply, include a dimmer if needed, and explore the installation diagrams provided.

		P	V	D (A x B x C)	
MINIMAL TRACK 24V Susp Power Supply Box	NO DIM	A400-00-06- NT WT	40W	24V	280 x 30 x 36mm
		A400-00-07- NT WT	100W	24V	280 x 30 x 36mm
MINIMAL TRACK 24V Remote Power Supply	NO DIM	0434-01-37	60W	24V	180 x 52 x 30mm
		0433-10-22	100W	24V	295 x 43 x 30mm
220V~ 240V~					
MINIMAL TRACK 24V Remote Constant Voltage Dimmer		0433-01-32	DALI / Push	24V	181 x 42 x 20mm
		0433-01-35	CASAMBI	24V	72,6 x 30 x 18mm

24V | other DIM options please consult

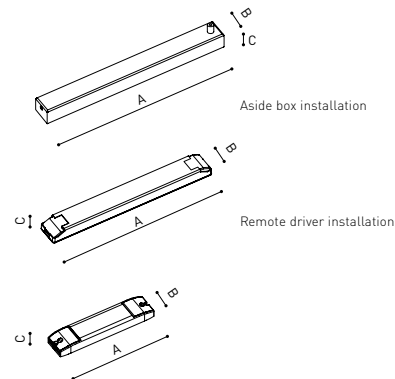

Connection diagram:

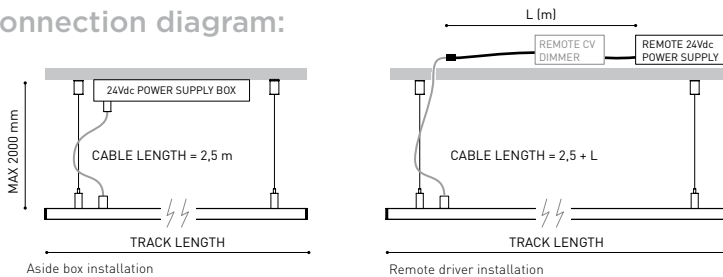

DROP VOLTAGE TABLE

POWER (W)	CABLE SECTION (mm ²)	CABLE LENGTH (m)			
		<5	<10	<20	<30
40	0,75	30	30	30	30
	1,5	30	30	30	30
60	0,75	30	30	20	10
	1,5	30	30	30	20
100	0,75	20	10	X	X
	1,5	20	20	10	X

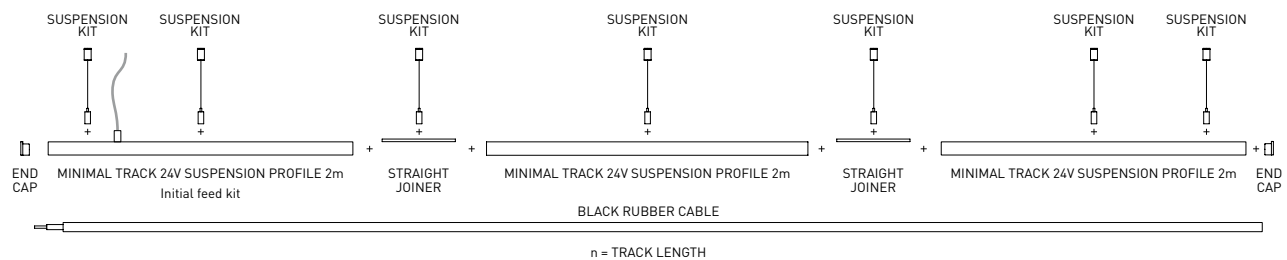

COLOUR | NT ■ RAL 9005 | WT □ RAL 9016 | N ■ RAL 9005 |





PRODUCT	
Model	Coaxial Trimless
Reference	A023-00-03- W N
Colour	W <input type="checkbox"/> RAL 9016 N <input checked="" type="checkbox"/> RAL 9005
Category	Accessories



Dimensional drawing

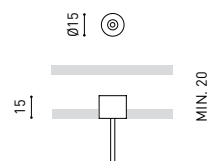

Accessory for trimless cable

Wire Trimless Accessory is a collection of accessories for fitting tensioners and cables to Arkoslight luminaires suspended directly from the ceiling with any visible ceiling rose or fixings. This achieves a minimalist application with a visually tidy finish.

With Wire Trimless Accessory the items adjacent to the ceiling of the standard product (ceiling roses, fixings, driver boxes, etc.) are concealed by a simple recessed application.

Wire Trimless Accessory reduces the visual impact of the installation leading to extremely minimalist aesthetics. The wires come out of the ceiling material as a part of the structure. This detail creates a much purer, more essential layout, particular when several luminaires are fitted in an arrangement.



INSTALLATION GUIDE

https://youtu.be/sa_xAgj4ji4



PRODUCT

Model	Trimless Tool D20 X D52 MM
Reference	A478-00-01
Category	Accessories

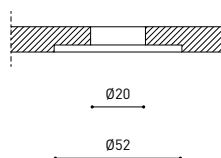
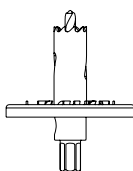



Fuente de luz (LED) reemplazable por un profesional autorizado

Replaceable (LED only) light source by an authorized professional.

Source lumineuse (LED) remplaçable par un professionnel agréé

Sorgente luminosa (LED) sostituibile da parte di un professionista autorizzato

Austauschbare (LED) Lichtquelle durch einen autorisierten Fachmann



Equipo de control reemplazable por un profesional autorizado

Replaceable control gear by an authorized professional

Dispositif de commande remplaçable par un professionnel agréé

Alimentatore sostituibile da parte di un professionista autorizzato

Auswechselbares Betriebsgerät durch autorisierten Fachmann

Instrucciones para el final de vida y la eliminación de los componentes:

Instructions on end-of-life and component disposal:

Instructions pour la gestion des composants en fin de vie et leur mise au rebut :

Istruzioni per il fine vita e lo smaltimento dei componenti:

Anweisungen zur entsorgung der Leuchtenkomponenten:



Interrumpir la alimentación del aparato
Cut the power supply to the luminaire
Couper l'alimentation du luminaire
Interrompere l'alimentazione dell'apparecchio
Stromversorgung der Leuchte unterbrechen



Quitar la(s) fuente(s) de luz para el desecho
Remove light source(s) for disposal
Retirer la (les) source(s) lumineuse(s) pour l'élimination
Rimuovere la/le sorgente/e di luce per lo smaltimento
Lichtquelle(n) zur Entsorgung entfernen



Quitar la batería para el desecho
Remove the battery for decommissioning
Retirer la batterie pour sa mise au rebut
Rimuovere la batteria per la dismissione
Die Batterie ordnungsgemäß entsorgen



Quitar el equipo de control para el desecho
Remove control gear for disposal
Retirer le dispositif de commande pour l'élimination
Rimuovere l'alimentatore per lo smaltimento
Betriebsgerät zur Entsorgung ausbauen



Enviar los materiales a un centro de recogida RAEE
Send the materials to a WEEE collection centre
Envoyer les matériaux dans une déchetterie DEEE
Inviare i materiali ad un centro di raccolta RAEE
Die Materialien in einem WEEE-Zentrum entsorgen

