

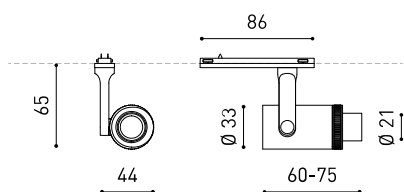

DIMENSIONI



ACCESSORI



MINIMAL TRACK OPTIONS

PREMI



Nome	PLUS MICRO 24V 2700K NT
Articolo	A3880000NT
Colore	Nero Strutturato
RAL	9005
Categoria	TRACKLIGHTS

SORGENTE DI LUCE

Tipo	LED
Flusso luminoso lordo	500 lm
Temperatura di colore	2700 K
Stabilità cromatica	MacAdam Step 3
Indice di Riproduzione Cromatica	CRI > 90
Potenza	4,7 W
Corrente	400 mA
Efficienza	106 lm/W
Ore di vita del LED	L80B10 > 60.000h

APPARECCHIO | DATI FOTOMETRICI

Efficienza luminosa	10-17%
Angolo del fascio di luce	10°-35°

APPARECCHIO | DATI ELETTRICI

Driver	Incluso
Valori di potenza del sistema	5,35 W
Tensione	24Vdc
Regolazione	Opzioni DIM
Classe di isolamento elettrico	II

ALTRI DATI

Tenuta stagna	IP20
Wireless control	Consultare
Angolo di oscillazione	180°
Angolo di rotazione	355°
Tipo de carril	Minimal Track
Peso	90 g
Peso compresso l'imballaggio	130 g
Dimensioni dell'imballaggio	113 x 100 x 48 mm
Unità per imballaggio	1
Materiali	Alluminio / Polimetilmetacrilato Ottico



Plus Micro 24V è un proiettore destinato al sistema Minimal Track capace di ampliare o concentrare l'apertura della sorgente di luce con un leggero intervento manuale. Questa caratteristica rende il Plus il proiettore ideale per applicazioni dove la precisione è essenziale.

DIAGRAMMA DI ABBAGLIAMENTO POLARE

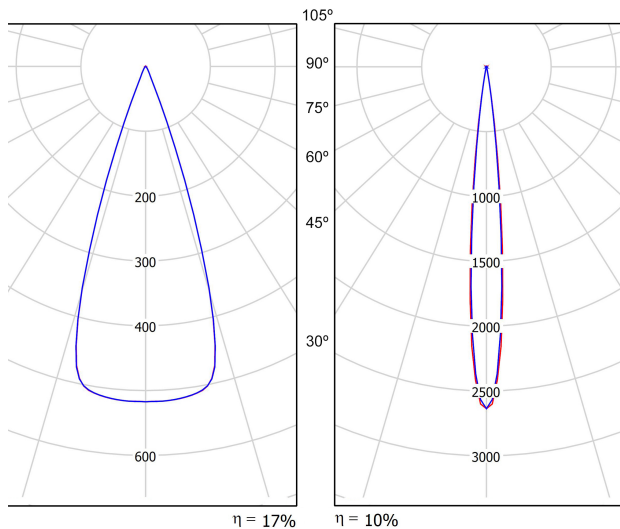

cd/klm
 — C0 - C180 — C90 - C270

DIAGRAMMA CONICO

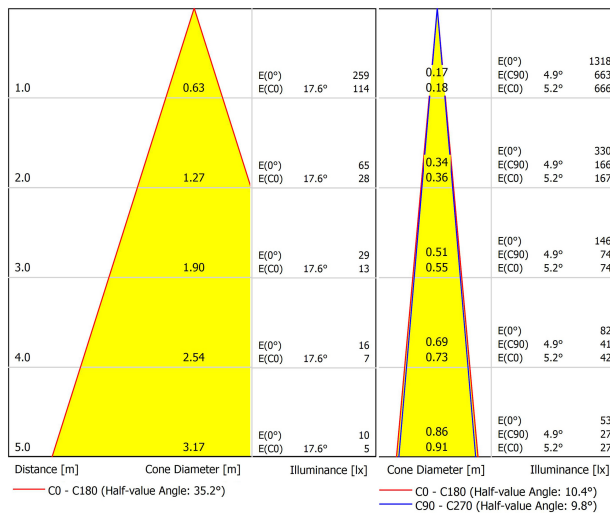

GUIDA D'INSTALLAZIONE



<https://youtu.be/KnedjbKp7oo>



MINIMAL TRACK 24V Profile 2m A384-02-00- | N | WT |



MINIMAL TRACK 24V Rubber Cable n x 1m A384-00-01- | N |

n = Total Length of System.

24V | Max. 4A

MINIMAL TRACK 24V Corner 90° 1 Plane

A384-00-02- | N | WT |

Cable Length = 35mm.



MINIMAL TRACK 24V Corner 90° 1 Plane Rounded

A384-00-03- | N | WT |

Cable Length = 35mm.



MINIMAL TRACK 24V Corner 90° 2 Planes

A384-00-04- | N | WT |

Cable Length = 100mm.



MINIMAL TRACK 24V End Cap

A384-00-05- | N | WT |



MINIMAL TRACK 24V Connection Box

A384-00-06- | N | WT |



			P	V	D [A x B x C]
MINIMAL TRACK 24V Power Supply Box	ON/OFF	A384-00-07- NT WT	40W	24V	280 x 30 x 24mm
		A384-00-08- NT WT	100W	24V	280 x 30 x 24mm

220
240 V~ | Included ON/OFF 24Vdc Power Supply.

MINIMAL TRACK 24V Remote Power Supply	ON/OFF	0434-01-37	60W	24V	180 x 52 x 30mm
		0433-10-22	100W	24V	295 x 43 x 30mm

220
240 V~

MINIMAL TRACK 24V Remote Constant Voltage Dimmer		0433-01-32	DALI / Push	24V	181 x 42 x 20mm
		0433-01-35	CASAMBI	24V	72,6 x 30 x 18mm
		0434-01-64	WIFI	24V	105 x 44 x 23mm

24V

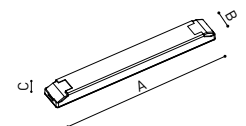

DROP VOLTAGE TABLE

POWER [W]	CABLE SECTION [mm²]	CABLE LENGTH [m]			
		<5	<10	<20	<30
40	0,75	30	30	30	30
	1,5	30	30	30	30
60	0,75	30	30	20	10
	1,5	30	30	30	20
100	0,75	20	10	X	X
	1,5	20	20	10	X



COLOUR | N ■ | NT ■ | WT □ |

DIM OPTIONS PLEASE CONSULT

INSTALLATION GUIDE
<https://youtu.be/KnedJbKp7oo>





MINIMAL TRACK 24V Suspension

Profile 2m

A384-02-00- | N | WT |

Profile 2m Initial feed kit

A400-02-10- | N | WT |

Profile 2m Middle feed kit*

A400-02-20- | N | WT |

* Unidirectional Middle Feed.

MINIMAL TRACK 24V Suspension Corner 90°

A400-00-03- | N | WT |

Cable Length = 85mm.



MINIMAL TRACK 24V Suspension

Rubber Cable n x 1m

A400-00-01- | N |

n = Total Length of System.

24V | Max. 4A

MINIMAL TRACK 24V Suspension Straight Joiner

A400-00-02- | N | WT |



MINIMAL TRACK 24V Suspension Kit

A400-02-04- | N | WT |

Max distance between suspension kits = 100 cm.



MINIMAL TRACK 24V Suspension End Caps

A400-00-05- | N | WT |

Two End Caps Included.



			P	V	D (A x B x C)
MINIMAL TRACK 24V Suspension Power Supply Box	ON/OFF	A400-00-06- NT WT	40W	24V	280 x 30 x 36mm
		A400-00-07- NT WT	100W	24V	280 x 30 x 36mm
220 V~ Included ON/OFF 24Vdc Power Supply.					
MINIMAL TRACK 24V Remote Power Supply	ON/OFF	0434-01-37	60W	24V	180 x 52 x 30mm
		0433-10-22	100W	24V	295 x 43 x 30mm
220 V~					
MINIMAL TRACK 24V Remote Constant Voltage Dimmer		0433-01-32	DALI / Push	24V	181 x 42 x 20mm
		0433-01-35	CASAMBI	24V	72,6 x 30 x 18mm
		0434-01-64	WIFI	24V	105 x 44 x 23mm



24V

DROP VOLTAGE TABLE

POWER (W)	CABLE SECTION (mm ²)	CABLE LENGTH (m)			
		<5	<10	<20	<30
40	0,75	30	30	30	30
	1,5	30	30	30	30
60	0,75	30	30	20	10
	1,5	30	30	30	20
100	0,75	20	10	X	X
	1,5	20	20	10	X



COLOUR | N ■ | NT ■ | WT □ |

DIM OPTIONS PLEASE CONSULT

MINIMAL TRACK TRIMLESS

ARKOSLIGHT



MINIMAL TRACK 24V Trimless

Profile 2m A467-02-00- | N |



MINIMAL TRACK 24V Trimless

Rubber Cable n x 1m A467-00-01- | N |

n = Total Length of System.

24V | Max. 4A

MINIMAL TRACK 24V Trimless

Corner 90° 1 Plane

A467-00-02- | N |

Cable Length = 140mm.



MINIMAL TRACK 24V Trimless

Corner 90° 1 Plane Connector

A467-00-03- | N |



MINIMAL TRACK 24V Trimless

Corner 90° 2 Planes

A467-00-04- | N |

Cable Length = 200mm.



MINIMAL TRACK 24V Trimless

End Caps

A467-00-05- | N |

Two End Caps Included



MINIMAL TRACK 24V Trimless

Straight Joiner

A467-00-06



MINIMAL TRACK 24V Trimless

Connection Box

A467-00-07- | N |



	ON/OFF		P	V	D (A x B x C)
MINIMAL TRACK 24V Remote Power Supply		0434-01-37	60W	24V	180 x 52 x 30mm
		0433-10-22	100W	24V	295 x 43 x 30mm

220 V~
240 V~

			P	V	D (A x B x C)
MINIMAL TRACK 24V Remote Constant Voltage Dimmer		0433-01-32	DALI / Push	24V	181 x 42 x 20mm
		0433-01-35	CASAMBI	24V	72,6 x 30 x 18mm
		0434-01-64	WIFI	24V	105 x 44 x 23mm

24V

DROP VOLTAGE TABLE

POWER (W)	CABLE SECTION (mm ²)	CABLE LENGTH (m)			
		<5	<10	<20	<30
60	0,75	30	30	20	10
	1,5	30	30	30	20
100	0,75	20	10	X	X
	1,5	20	20	10	X

Reduce 5 meters per each 'Corner 90° 1 Plane CONNECTOR' used.

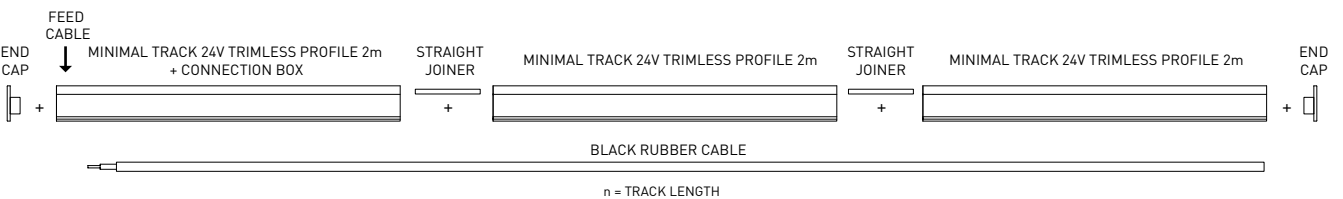

COLOUR | N ■ |

DIM OPTIONS PLEASE CONSULT

INSTALLATION GUIDE
<https://youtu.be/KnedJbKp7oo>



Calle N · Pol. Ind. EL OLIVERAL
46394 Ribarroja del Turia · Valencia (Spain)
Tel. +34 961 667 207 · Fax +34 961 667 054
info@arkoslight.com · www.arkoslight.com





PRODUCT	
Model	Coaxial Trimless
Reference	A023-00-03- W N
Colour	W <input type="checkbox"/> RAL 9016 N <input type="checkbox"/> RAL 9005
Category	Accessories
Fasteners not available	
	 REMOTE  INCL  Ø20

DIMENSIONAL DRAWING



Wire Trimless Accessory è una collezione di accessori che permettono di installare i tenditori e i cavi degli apparecchi a sospensione di Arkoslight direttamente al soffitto, senza rosone né fissaggio a vista. In questo modo si ottiene un'applicazione minimalista e visibilmente pulita nello spazio.

Con i Wire Trimless Accessory gli elementi adiacenti al soffitto del prodotto standard (rosone, fissaggi, scatole di driver...) si nascondono mediante una semplice applicazione ad incasso.

Wire Trimless Accessory riduce il peso visivo dell'impianto e crea un'estetica estremamente minimalista. I cavi nascono dal materiale al soffitto come parte della struttura. Questo dettaglio crea una disposizione molto più pura ed essenziale, soprattutto nelle composizioni di varie unità.



Fuente de luz (LED) reemplazable por un profesional autorizado

Replaceable (LED only) light source by an authorized professional.

Source lumineuse (LED) remplaçable par un professionnel agréé

Sorgente luminosa (LED) sostituibile da parte di un professionista autorizzato

Austauschbare (LED) Lichtquelle durch einen autorisierten Fachmann



Equipo de control reemplazable por un profesional autorizado

Replaceable control gear by an authorized professional

Dispositif de commande remplaçable par un professionnel agréé

Alimentatore sostituibile da parte di un professionista autorizzato

Auswechselbares Betriebsgerät durch autorisierten Fachmann

INSTRUCCIONES PARA EL FINAL DE VIDA Y LA ELIMINACIÓN LOS COMPONENTES
 INSTRUCTIONS ON END-OF-LIFE AND COMPONENT DISPOSAL
 INSTRUCTIONS POUR LA GESTION DES COMPOSANTS EN FIN DE VIE ET LEUR MISE AU REBUT
 ISTRUZIONI PER IL FINE VITA E LO SMALTIMENTO DEI COMPONENTI
 ANWEISUNGEN ZUR ENTSORGUNG DER LEUCHTENKOMPONENTEN



Interrumpir la alimentación del aparato
 Cut the power supply to the luminaire
 Couper l'alimentation du luminaire
 Interrompere l'alimentazione dell'apparecchio
 Stromversorgung der Leuchte unterbrechen



Quitar la(s) fuente(s) de luz para el desecho
 Remove light source(s) for disposal
 Retirer la (les) source(s) lumineuse(s) pour l'élimination
 Rimuovere la/le sorgente/e di luce per lo smaltimento
 Lichtquelle(n) zur Entsorgung entfernen



Quitar la batería para el desecho
 Remove the battery for decommissioning
 Retirer la batterie pour sa mise au rebut
 Rimuovere la batteria per la dismissione
 Die Batterie ordnungsgemäß entsorgen



Quitar el equipo de control para el desecho
 Remove control gear for disposal
 Retirer le dispositif de commande pour l'élimination
 Rimuovere l'alimentatore per lo smaltimento
 Betriebsgerät zur Entsorgung ausbauen



Enviar los materiales a un centro de recogida RAEE
 Send the materials to a WEEE collection centre
 Envoyer les matériaux dans une déchetterie DEEE
 Inviare i materiali ad un centro di raccolta RAEE
 Die Materialien in einem WEEE-Zentrum entsorgen

