

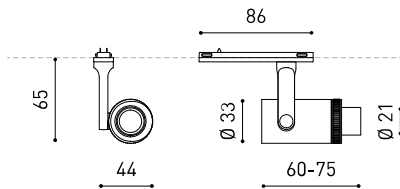

Dimensioni



Accessori



MINIMAL TRACK OPTIONS

Premi



reddot winner 2020
innovative product
& lighting design



Bronze Delta
ADI Awards 2020



HONORABLE MENTION
EUROPEAN
PRODUCT
DESIGN
AWARD



WINNER
2020



archiproducts
DESIGN AWARDS
WINNER 2020



ORO

PRODOTTO

| | |
|-----------|-------------------------|
| Nome | PLUS MICRO 24V 2700K WT |
| Articolo | A3880000WT |
| Colore | Bianco Strutturato |
| RAL | 9016 |
| Categoria | TRACK LIGHTS |

SORGENTE DI LUCE

| | |
|----------------------------------|------------------|
| Tipo | LED |
| Flusso luminoso lordo | 530 lm |
| Temperatura di colore | 2700 K |
| Stabilità cromatica | MacAdam Step 2 |
| Indice di Riproduzione Cromatica | CRI > 90 |
| Potenza | 4,7 W |
| Corrente | 400 mA |
| Efficienza | 113 lm/W |
| Ore di vita del LED | L90B10 > 60.000h |
| Classe di efficienza energetica | F |

APPARECCHIO | DATI FOTOMETRICI

| | |
|---------------------------|---------|
| Efficienza luminosa | 10-17% |
| Angolo del fascio di luce | 10°-35° |

APPARECCHIO | DATI ELETTRICI

| | |
|--------------------------------|-------------|
| Valori di potenza del sistema | 5,35 W |
| Tensione | 24Vdc |
| Regolazione | Opzioni DIM |
| Classe di isolamento elettrico | III |

ALTRI DATI

| | |
|------------------------------|---|
| Tenuta stagna | IP20 |
| Wireless control | Consultare |
| Angolo di oscillazione | 180° |
| Angolo di rotazione | 355° |
| Tipo de carril | Minimal Track |
| Peso | 90 g |
| Peso compresso l'imballaggio | 130 g |
| Dimensioni dell'imballaggio | 113 x 100 x 48 mm |
| Unità per imballaggio | 1 |
| Materiali | Alluminio / Polimetilmetacrilato Ottico |



Plus Micro 24V è un proiettore destinato al sistema Minimal Track capace di ampliare o concentrare l'apertura della sorgente di luce con un leggero intervento manuale. Questa caratteristica rende il Plus il proiettore ideale per applicazioni dove la precisione è essenziale.

Diagramma di abbagliamento polare

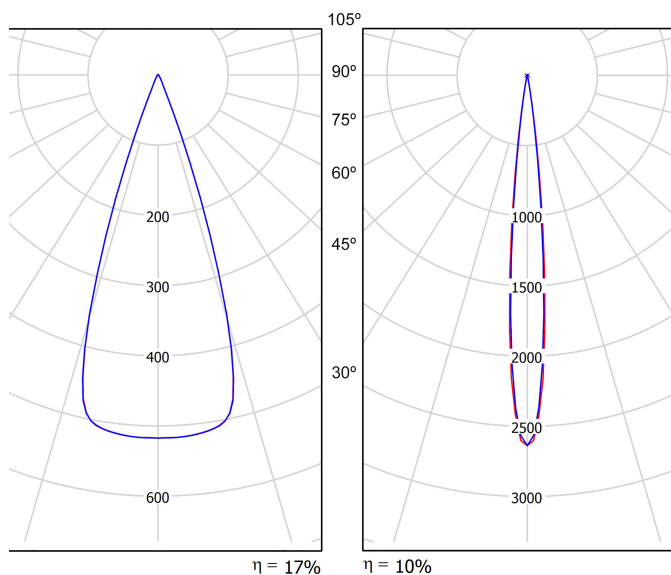

cd/klm
 — C0 - C180 — C90 - C270

Diagramma conico

| Distance [m] | Cone Diameter [m] | Illuminance [lx] | Cone Diameter [m] | Illuminance [lx] |
|--------------|-------------------|------------------------------|-------------------|---|
| 1.00 | 0.63 | E(0°) 274 E(C0) 17.6° 121 | 0.17 0.18 | E(0°) 1398 E(C90) 4.9° 703 E(C0) 5.2° 706 |
| 2.00 | 1.27 | E(0°) 69 E(C0) 17.6° 30 | 0.34 0.36 | E(0°) 349 E(C90) 4.9° 176 E(C0) 5.2° 177 |
| 3.00 | 1.90 | E(0°) 30 E(C0) 17.6° 13 | 0.51 0.55 | E(0°) 155 E(C90) 4.9° 78 E(C0) 5.2° 78 |
| 4.00 | 2.54 | E(0°) 17 E(C0) 17.6° 8 | 0.69 0.73 | E(0°) 87 E(C90) 4.9° 44 E(C0) 5.2° 44 |
| | 3.17 | E(0°) 11 E(C0) 17.6° 5 | 0.86 0.91 | E(0°) 56 E(C90) 4.9° 28 E(C0) 5.2° 28 |

— C0 - C180 (Half-value Angle: 35.2°) — C90 - C270 (Half-value Angle: 9.8°)
 — C0 - C180 (Half-value Angle: 10.4°)

Guida d'installazione



<https://youtu.be/KnedJbKp7oo>

Minimal Track

ARKOSLIGHT

Minimal Track is a 24V low-voltage lighting system designed to create minimalist and highly configurable installations. On this page, you'll find the necessary components to configure your surface-mounted system.



Or use our online configurator to design your own custom product layout. The tool will guide you through the process and automatically calculate the required drivers and accessories. [Start your configuration →](#)



Track & accessories - Surface mounting

Configure the shape of your track, add end caps and the required accessories, and finish the setup with the conductive strip (rubber cable).

MINIMAL TRACK 24V

Profile 2m

A384-02-00- | N | WT |

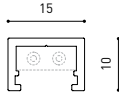

Corner 90° 1 Plane

A384-00-02- | N | WT |

Cable length = 35mm.

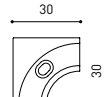

End Cap

A384-00-05- | N | WT |



Rubber Cable n x 1m

A384-00-01- | N |

n = Total length of System

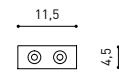

Corner 90° 1 Plane Rounded

A384-00-03- | N | WT |

Cable length = 35mm.

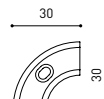

Connection Box

A384-00-06- | N | WT |

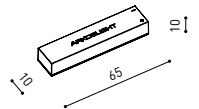

24V | Max. 4A | III

Corner 90° 2 Planes

A384-00-04- | N | WT |

Cable length = 100mm.

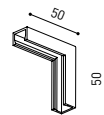

Power Supply

Select your power supply, include a dimmer if needed, and explore the installation diagrams provided.

| | | P | V | D (A x B x C) |
|---|--------|-----------------------|-------------|----------------------|
| MINIMAL TRACK 24V Power Supply Box | NO DIM | A384-00-07- NT WT | 40W | 24V 280 x 30 x 24mm |
| | | A384-00-08- NT WT | 100W | 24V 280 x 30 x 24mm |
| MINIMAL TRACK 24V Remote Power Supply | NO DIM | 0434-01-37 | 60W | 24V 180 x 52 x 30mm |
| | | 0433-10-22 | 100W | 24V 295 x 43 x 30mm |
| MINIMAL TRACK 24V Remote Constant Voltage Dimmer | | 0433-01-32 | DALI / Push | 24V 181 x 42 x 20mm |
| | | 0433-01-35 | CASAMBI | 24V 72,6 x 30 x 18mm |

220 V ~
240 V ~

24V | other DIM options please consult

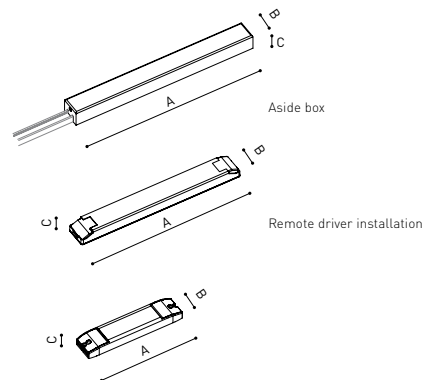

Connection diagram:

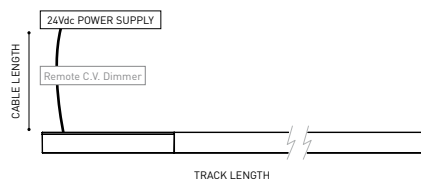

DROP VOLTAGE TABLE

| POWER (W) | CABLE SECTION (mm²) | CABLE LENGTH (m) | | | |
|-----------|---------------------|------------------|-----|-----|-----|
| | | <5 | <10 | <20 | <30 |
| 40 | 0,75 | 30 | 30 | 30 | 30 |
| | 1,5 | 30 | 30 | 30 | 30 |
| 60 | 0,75 | 30 | 30 | 20 | 10 |
| | 1,5 | 30 | 30 | 30 | 20 |
| 100 | 0,75 | 20 | 10 | X | X |
| | 1,5 | 20 | 20 | 10 | X |

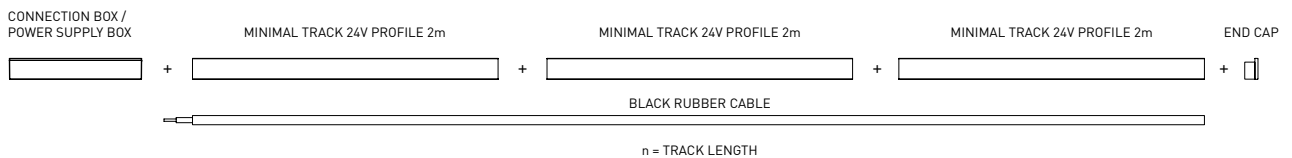

COLOUR | NT ■ RAL 9005 | WT □ RAL 9016 | N ■ RAL 9005 |

INSTALLATION GUIDE
<https://youtu.be/KnedJbKp7oo>



Minimal Track

ARKOSLIGHT

Minimal Track is a 24V low-voltage lighting system designed to create minimalist and highly configurable installations. On this page, you'll find the necessary components to configure your trimless-mounted system.



Or use our online configurator to design your own custom product layout. The tool will guide you through the process and automatically calculate the required drivers and accessories. [Start your configuration →](#)

Track & accessories - Trimless mounting

Configure the shape of your track, add end caps and the required accessories, and finish the setup with the conductive strip (rubber cable).

MINIMAL TRACK 24V

Trimless Profile 2m

A467-02-00- | N |

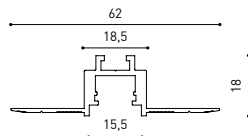

Trimless Rubber Cable n x 1m

A467-00-01- | N |

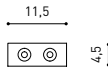

n = Total length of System

24 V | Max. 4A |

Trimless Corner 90° 1 Plane

A467-00-02- | N |

Cable length = 140mm.

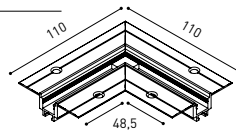

Trim. Corner 90° 1 Plane Connc.

A467-00-03- | N |



Trimless End Caps

A467-00-05- | N |

Two End Caps Included



Trimless Straight Joiner

A467-00-06

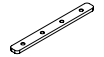

Trimless Connection Box

A467-00-07- | N |

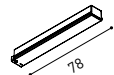

Power Supply

Select your power supply, include a dimmer if needed, and explore the installation diagrams provided.

| | | P | V | D (A x B x C) |
|---------------------------------------|------------|------|-----|-----------------|
| MINIMAL TRACK 24V Remote Power Supply | 0434-01-37 | 60W | 24V | 180 x 52 x 30mm |
| | 0433-10-22 | 100W | 24V | 295 x 43 x 30mm |

220 V ~
240

| | | | V | D (A x B x C) |
|--|------------|-------------|-----|------------------|
| MINIMAL TRACK 24V Remote Constant Voltage Dimmer | 0433-01-32 | DALI / Push | 24V | 181 x 42 x 20mm |
| | 0433-01-35 | CASAMBI | 24V | 72,6 x 30 x 18mm |

24V | other DIM options please consult

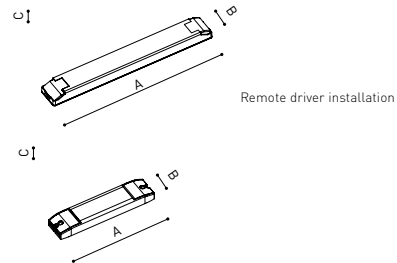

Connection diagram:

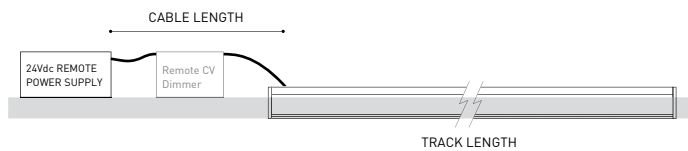

DROP VOLTAGE TABLE

| POWER (W) | CABLE SECTION (mm ²) | CABLE LENGTH (m) | | | |
|-----------|----------------------------------|------------------|-----|-----|-----|
| | | <5 | <10 | <20 | <30 |
| 40 | 0,75 | 30 | 30 | 30 | 30 |
| | 1,5 | 30 | 30 | 30 | 30 |
| 60 | 0,75 | 30 | 30 | 20 | 10 |
| | 1,5 | 30 | 30 | 30 | 20 |
| 100 | 0,75 | 20 | 10 | X | X |
| | 1,5 | 20 | 20 | 10 | X |

Reduce 5 meters per each 'Corner 90° 1 Plane CONNECTOR' used.

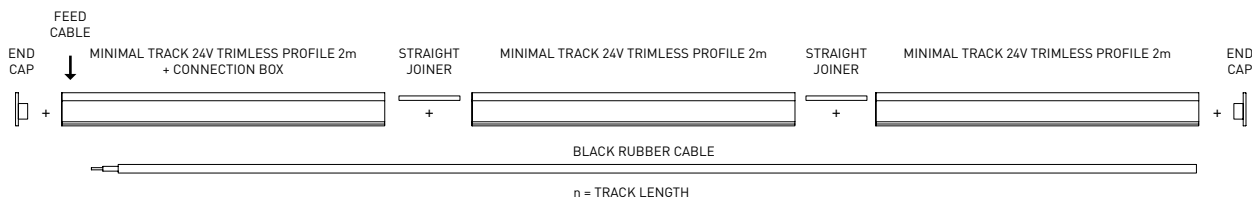

COLOUR | NT ■ RAL 9005 | WT □ RAL 9016 | N ■ RAL 9005 |

INSTALLATION GUIDE
<https://youtu.be/KnedJbKp7oo>



Minimal Track

ARKOSLIGHT

Minimal Track is a 24V low-voltage lighting system designed to create minimalist and highly configurable installations. On this page, you'll find the necessary components to configure your suspension-mounted system.



Or use our online configurator to design your own custom product layout. The tool will guide you through the process and automatically calculate the required drivers and accessories. [Start your configuration →](#)

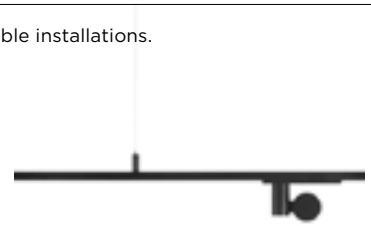

Track & accessories - Suspension mounting

Configure the shape of your track, add end caps and the required accessories, and finish the setup with the conductive strip (rubber cable).

MINIMAL TRACK 24V Suspension

Profile 2m
A384-02-00- | N | WT |

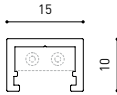

Rubber Cable n x 1m
A384-00-01- | N |

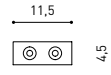

Suspension Straight Joiner
A400-00-02- | N | WT |



Profile 2m Initial feed kit
A400-02-10- | N | WT |

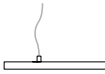

24V | Max. 4A | III

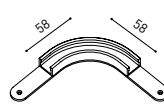

Suspension Kit
A400-02-04- | N | WT |

Max distance between suspension kits = 100 cm.

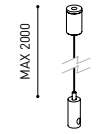

Profile 2m Middle feed kit*
A400-02-20- | N | WT |

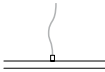

Corner 90°
A400-00-03- | N | WT |

Cable length = 85mm.

Suspension End Caps
A400-00-05- | N | WT |

Two End Caps Included.



* Unidirectional Middle Feed.

Power Supply

Select your power supply, include a dimmer if needed, and explore the installation diagrams provided.

| | | P | V | D (A x B x C) | |
|--|--------|-----------------------|------|---------------|-----------------|
| MINIMAL TRACK 24V Susp Power Supply Box | NO DIM | A400-00-06- NT WT | 40W | 24V | 280 x 30 x 36mm |
| | | A400-00-07- NT WT | 100W | 24V | 280 x 30 x 36mm |
| MINIMAL TRACK 24V Remote Power Supply | NO DIM | 0434-01-37 | 60W | 24V | 180 x 52 x 30mm |
| | | 0433-10-22 | 100W | 24V | 295 x 43 x 30mm |

220V-
240V

| MINIMAL TRACK 24V Remote Constant Voltage Dimmer | | 0433-01-32 | DALI / Push | 24V | 181 x 42 x 20mm |
|--|--|------------|-------------|-----|------------------|
| | | 0433-01-35 | CASAMBI | 24V | 72,6 x 30 x 18mm |

24V | other DIM options please consult

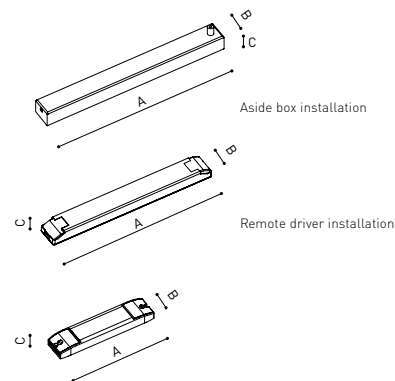

Connection diagram:

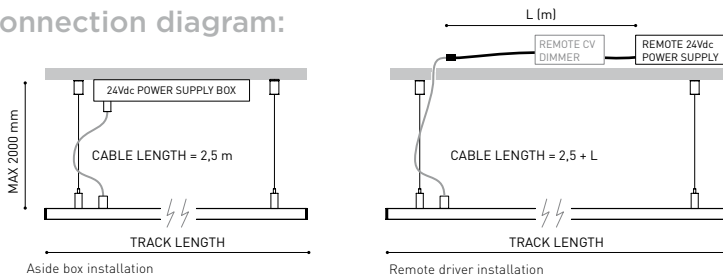

DROP VOLTAGE TABLE

| POWER (W) | CABLE SECTION (mm ²) | CABLE LENGTH (m) | | | |
|-----------|----------------------------------|------------------|-----|-----|-----|
| | | <5 | <10 | <20 | <30 |
| 40 | 0,75 | 30 | 30 | 30 | 30 |
| | 1,5 | 30 | 30 | 30 | 30 |
| 60 | 0,75 | 30 | 30 | 20 | 10 |
| | 1,5 | 30 | 30 | 30 | 20 |
| 100 | 0,75 | 20 | 10 | X | X |
| | 1,5 | 20 | 20 | 10 | X |

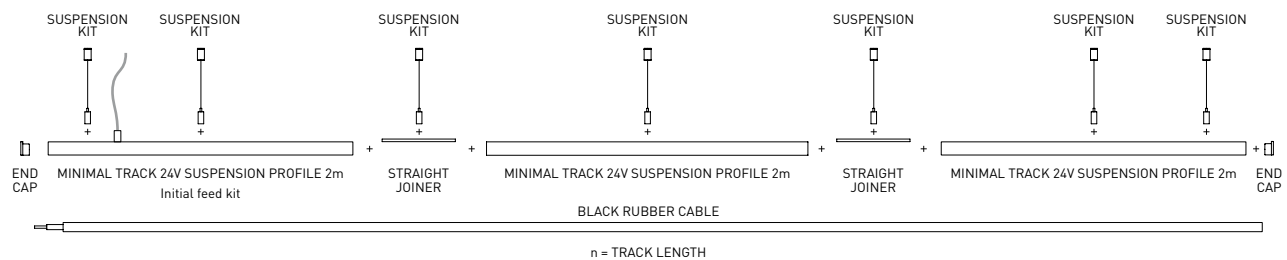

COLOUR | NT ■ RAL 9005 | WT □ RAL 9016 | N ■ RAL 9005 |



| PRODUCT | |
|-----------|---|
| Model | Coaxial Trimless |
| Reference | A023-00-03- W N |
| Colour | W <input type="checkbox"/> RAL 9016 N <input type="checkbox"/> RAL 9005 |
| Category | Accessories |



Dimensional drawing

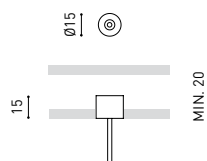

Accessorio per cavo trimless

Wire Trimless Accessory è una collezione di accessori che permettono di installare i tenditori e i cavi degli apparecchi a sospensione di Arkoslight direttamente al soffitto, senza rosone né fissaggio a vista. In questo modo si ottiene un'applicazione minimalista e visibilmente pulita nello spazio.

Con i Wire Trimless Accessory gli elementi adiacenti al soffitto del prodotto standard (rosoni, fissaggi, scatole di driver...) si nascondono mediante una semplice applicazione ad incasso.

Wire Trimless Accessory riduce il peso visivo dell'impianto e crea un'estetica estremamente minimalista. I cavi nascono dal materiale al soffitto come parte della struttura. Questo dettaglio crea una disposizione molto più pura ed essenziale, soprattutto nelle composizioni di varie unità.



INSTALLATION GUIDE

https://youtu.be/sa_xAgj4ji4



PRODUCT

| | |
|-----------|-----------------------------------|
| Model | Trimless Tool D20 X D52 MM |
| Reference | A478-00-01 |
| Category | Accessories |

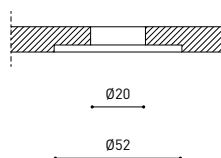
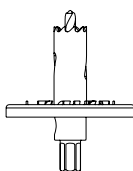



Fuente de luz (LED) reemplazable por un profesional autorizado
 Replaceable (LED only) light source by an authorized professional.
 Source lumineuse (LED) remplaçable par un professionnel agréé
 Sorgente luminosa (LED) sostituibile da parte di un professionista autorizzato
 Austauschbare (LED) Lichtquelle durch einen autorisierten Fachmann



Equipo de control reemplazable por un profesional autorizado
 Replaceable control gear by an authorized professional
 Dispositif de commande remplaçable par un professionnel agréé
 Alimentatore sostituibile da parte di un professionista autorizzato
 Auswechselbares Betriebsgerät durch autorisierten Fachmann

Instrucciones para el final de vida y la eliminación de los componentes:

Instructions on end-of-life and component disposal:

Instructions pour la gestion des composants en fin de vie et leur mise au rebut :

Istruzioni per il fine vita e lo smaltimento dei componenti:

Anweisungen zur entsorgung der Leuchtenkomponenten:



Interrumpir la alimentación del aparato
 Cut the power supply to the luminaire
 Couper l'alimentation du luminaire
 Interrompere l'alimentazione dell'apparecchio
 Stromversorgung der Leuchte unterbrechen



Quitar la(s) fuente(s) de luz para el desecho
 Remove light source(s) for disposal
 Retirer la (les) source(s) lumineuse(s) pour l'élimination
 Rimuovere la/le sorgente/e di luce per lo smaltimento
 Lichtquelle(n) zur Entsorgung entfernen



Quitar la batería para el desecho
 Remove the battery for decommissioning
 Retirer la batterie pour sa mise au rebut
 Rimuovere la batteria per la dismissione
 Die Batterie ordnungsgemäß entsorgen



Quitar el equipo de control para el desecho
 Remove control gear for disposal
 Retirer le dispositif de commande pour l'élimination
 Rimuovere l'alimentatore per lo smaltimento
 Betriebsgerät zur Entsorgung ausbauen



Enviar los materiales a un centro de recogida RAEE
 Send the materials to a WEEE collection centre
 Envoyer les matériaux dans une déchetterie DEEE
 Inviare i materiali ad un centro di raccolta RAEE
 Die Materialien in einem WEEE-Zentrum entsorgen

