

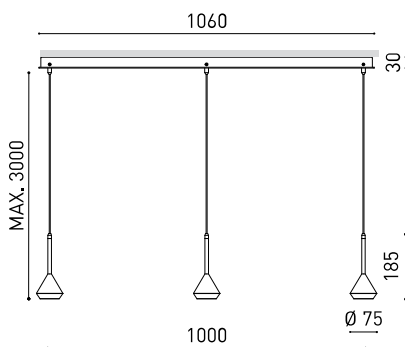

DIMENSIONS



AWARDS



PRODUCT

Name	SPIN 3 BASE 3M 24° 3000K NT-NT
Reference	A3911101NTNT
Color	Textured black
Base Finishing	Textured black
RAL	9005
Category	SUSPENSION

LIGHT SOURCE

Type	LED
Gross luminous flux	3 X 630 lm
Colour temperature	3000 K
Chromatic stability	MacAdam Step 2
Colour Rendering Index	CRI>90
Power	3 x 6,5 W
Current	700 mA
Efficacy	97 lm/W
LED lifespan	L90B10 >60.000h

LIGHTING FIXTURE | PHOTOMETRIC DATA

Lighting efficiency	86%
Light beam angle	24°

LIGHTING FIXTURE | ELECTRICAL DATA

Driver	Included
Power values of the system	3 x 8,62 W
Frequency	50/60 Hz
Dimming	No Dim - Other DIM, please consult
Electrical insulation class	<input type="checkbox"/>

OTHER DATA

Sealing	IP20
Wireless control	Please Consult
Cord length	Max. 3 m
Fast adjustment tensioner	No
Weight	4150 g
Packaged weight	4577 g
Packaging dimensions	1078 x 139 x 89 mm
Units per package	1
Materials	Aluminium / Polymethyl Methacrylate



Spin Base is a version that allows it to be installed in places where it is impossible to access the false ceiling. Cement, concrete, vault ... its base, set to apply three luminaires, houses the driver and allows the luminaire to be installed on all types of surfaces.

POLAR DIAGRAM



CONICAL DIAGRAM





Fuente de luz (LED) reemplazable por un profesional autorizado

Replaceable (LED only) light source by an authorized professional.

Source lumineuse (LED) remplaçable par un professionnel agréé

Sorgente luminosa (LED) sostituibile da parte di un professionista autorizzato

Austauschbare (LED) Lichtquelle durch einen autorisierten Fachmann



Equipo de control reemplazable por un profesional autorizado

Replaceable control gear by an authorized professional

Dispositif de commande remplaçable par un professionnel agréé

Alimentatore sostituibile da parte di un professionista autorizzato

Auswechselbares Betriebsgerät durch autorisierten Fachmann

INSTRUCCIONES PARA EL FINAL DE VIDA Y LA ELIMINACIÓN LOS COMPONENTES
 INSTRUCTIONS ON END-OF-LIFE AND COMPONENT DISPOSAL
 INSTRUCTIONS POUR LA GESTION DES COMPOSANTS EN FIN DE VIE ET LEUR MISE AU REBUT
 ISTRUZIONI PER IL FINE VITA E LO SMALTIMENTO DEI COMPONENTI
 ANWEISUNGEN ZUR ENTSORGUNG DER LEUCHTENKOMPONENTEN



Interrumpir la alimentación del aparato
 Cut the power supply to the luminaire
 Couper l'alimentation du luminaire
 Interrompere l'alimentazione dell'apparecchio
 Stromversorgung der Leuchte unterbrechen



Quitar la(s) fuente(s) de luz para el desecho
 Remove light source(s) for disposal
 Retirer la (les) source(s) lumineuse(s) pour l'élimination
 Rimuovere la/le sorgente/e di luce per lo smaltimento
 Lichtquelle(n) zur Entsorgung entfernen



Quitar la batería para el desecho
 Remove the battery for decommissioning
 Retirer la batterie pour sa mise au rebut
 Rimuovere la batteria per la dismissione
 Die Batterie ordnungsgemäß entsorgen



Quitar el equipo de control para el desecho
 Remove control gear for disposal
 Retirer le dispositif de commande pour l'élimination
 Rimuovere l'alimentatore per lo smaltimento
 Betriebsgerät zur Entsorgung ausbauen



Enviar los materiales a un centro de recogida RAEE
 Send the materials to a WEEE collection centre
 Envoyer les matériaux dans une déchetterie DEEE
 Inviare i materiali ad un centro di raccolta RAEE
 Die Materialien in einem WEEE-Zentrum entsorgen

