

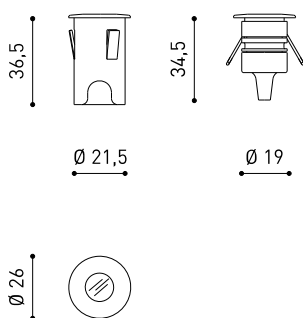

## DIMENSIONS



## ACCESSORIES



## DRIVER OPTIONS

Name	STEP XS 4000K N
Reference	A3930002N
Color	Black
RAL	9005
Category	OUTDOOR

## PRODUCT

Type	LED
Gross luminous flux	130 lm
Colour temperature	4000 K
Chromatic stability	MacAdam Step 3
Colour Rendering Index	CRI > 90
Power	1 W
Current	350 mA
Efficacy	130 lm/W
LED lifespan	L90B10 > 102.000h

## LIGHT SOURCE

Lighting efficiency	7%
Light beam angle	110°

## LIGHTING FIXTURE | PHOTOMETRIC DATA

Driver	Excluded: Must be placed on remote
Dimming	No Dim - Other DIM, please consult
Electrical insulation class	III

## LIGHTING FIXTURE | ELECTRICAL DATA

Sealing	IP65
Wireless control	Please Consult
Impact resistance	IK10
Recess measurements	Ø22 mm
Outdoor Use	Yes
Maximum surface temperature	50°
Supported load	5000
Weight	30 g
Packaged weight	57 g
Packaging dimensions	67 x 63 x 60 mm
Units per package	1
Materials	Stainless Steel (AISI 304) / Aluminium / Polymethyl Methacrylate

## OTHER DATA



Step is a floor-recessed luminaire for signage functions. Discrete, elegant and functional, it offers the technical features of a leaktight LED luminaire that is able to support weight loads. It is applicable in pedestrian transit areas, both outdoors and indoors. Other outstanding features are its small size, low consumption and considerable durability. A technical film, in blue or white finish, on the illuminated Step surface, helps prevent the LED point from being marked and makes the colour more homogeneous. Step can be installed horizontally or vertically. \*\*\* NOTE: Recessed box included

POLAR DIAGRAM

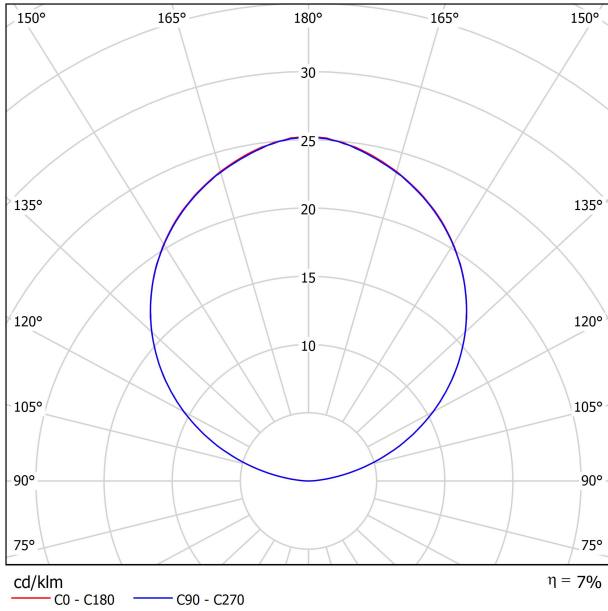

CONICAL DIAGRAM

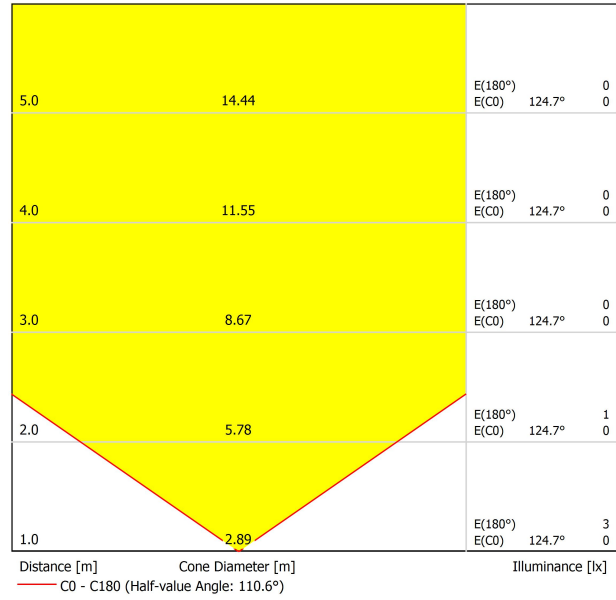

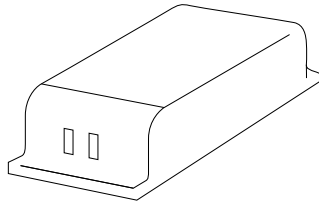

DRIVER OPTIONS		P	I	
<b>0434-00-39</b>	 NO DIM	1W	350mA	1 to 12 Steps
220 240 V~				IP20



Fuente de luz (LED) reemplazable por un profesional autorizado

Replaceable (LED only) light source by an authorized professional.

Source lumineuse (LED) remplaçable par un professionnel agréé

Sorgente luminosa (LED) sostituibile da parte di un professionista autorizzato

Austauschbare (LED) Lichtquelle durch einen autorisierten Fachmann



Equipo de control reemplazable por un profesional autorizado

Replaceable control gear by an authorized professional

Dispositif de commande remplaçable par un professionnel agréé

Alimentatore sostituibile da parte di un professionista autorizzato

Auswechselbares Betriebsgerät durch autorisierten Fachmann

INSTRUCCIONES PARA EL FINAL DE VIDA Y LA ELIMINACIÓN LOS COMPONENTES  
 INSTRUCTIONS ON END-OF-LIFE AND COMPONENT DISPOSAL  
 INSTRUCTIONS POUR LA GESTION DES COMPOSANTS EN FIN DE VIE ET LEUR MISE AU REBUT  
 ISTRUZIONI PER IL FINE VITA E LO SMALTIMENTO DEI COMPONENTI  
 ANWEISUNGEN ZUR ENTSORGUNG DER LEUCHTENKOMPONENTEN



Interrumpir la alimentación del aparato  
 Cut the power supply to the luminaire  
 Couper l'alimentation du luminaire  
 Interrompere l'alimentazione dell'apparecchio  
 Stromversorgung der Leuchte unterbrechen



Quitar la(s) fuente(s) de luz para el desecho  
 Remove light source(s) for disposal  
 Retirer la (les) source(s) lumineuse(s) pour l'élimination  
 Rimuovere la/le sorgente/e di luce per lo smaltimento  
 Lichtquelle(n) zur Entsorgung entfernen



Quitar la batería para el desecho  
 Remove the battery for decommissioning  
 Retirer la batterie pour sa mise au rebut  
 Rimuovere la batteria per la dismissione  
 Die Batterie ordnungsgemäß entsorgen



Quitar el equipo de control para el desecho  
 Remove control gear for disposal  
 Retirer le dispositif de commande pour l'élimination  
 Rimuovere l'alimentatore per lo smaltimento  
 Betriebsgerät zur Entsorgung ausbauen



Enviar los materiales a un centro de recogida RAEE  
 Send the materials to a WEEE collection centre  
 Envoyer les matériaux dans une déchetterie DEEE  
 Inviare i materiali ad un centro di raccolta RAEE  
 Die Materialien in einem WEEE-Zentrum entsorgen

