



Größe



Zubehör



HONEYCOMB LOUVER



MINIMAL TRACK OPTIONS

Preise



reddot winner 2020
innovative product
& lighting design



Bronze Delta
ADI Awards 2020



EUROPEAN
PRODUCT
DESIGN
AWARD



WINNER
2020



archiproducts
DESIGN AWARDS
WINNER 2020



ORO

PRODUKT

Name	FIT 27 24V 1 SPOT 2700K G
Artikelnummer	A3990010G
Farbe	Gold
RAL	Paint of metallic nanoparticles
Kategorie	TRACK LIGHTS

LICHTQUELLE

Typ	LED
Bruttolichtstrom	440 lm
Farbtemperatur	2700 K
Farbstabilität	MacAdam Step 2
Farbwiedergabeindex	CRI>90
Leistung	4,5 W
Stromstärke	400 mA
Lichtausbeute	98 lm/W
Nutzlebensdauer der LED in Betriebsstunden	L90B10 >108.000h
Energieeffizienzklasse	F

LEUCHE | PHOTOMETRISCHE DATEN

Leuchtenwirkungsgrad (LOR)	84%
Abstrahlwinkel	18°

LEUCHE | ELEKTRISCHE DATEN

Leistungswerte des Systems	5,14 W
Spannung	24Vdc
Helligkeitssteuerung	DIM-Optionen
Schutzklasse	III

ANDERE DATEN

Dichtigkeit	IP20
Wireless control	Bitte anfragen
Schwenkwinkel	90°
Drehwinkel	355°
Schiennentyp	Minimal Track
Gewicht	75 g
Gewicht inkl. Verpackung	115 g
Abmessungen der Verpackung	113 x 111 x 32 mm
Stück pro Verpackung	1
Materialien	Aluminium / Polycarbonat



Fit 27 24V ist ein Strahler für das Minimal Track System. Die zylindrische Geometrie und die wesentlichen Formen zeichnen sich durch ästhetischen Minimalismus und Funktionalität aus, da sie in alle Richtungen ausgerichtet werden können. Der Umfang des Randes in Schwarz betont seine blendfreie Berufung.

Polar-kordinaten diagramm

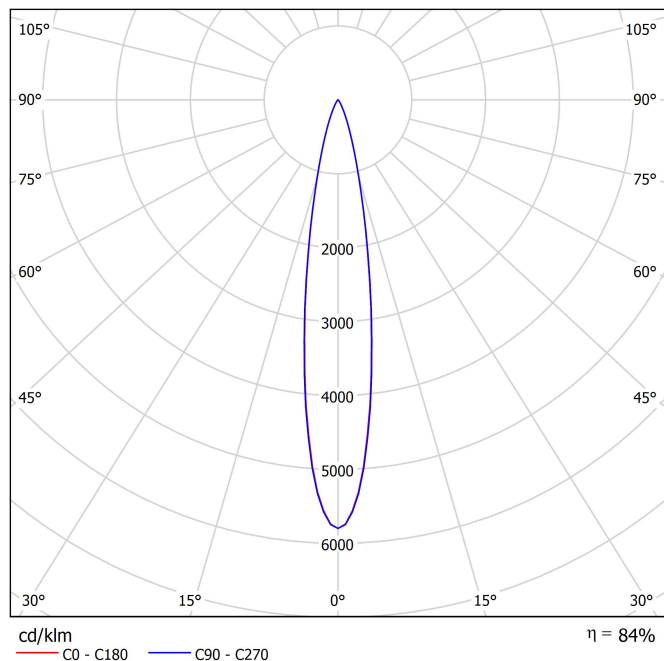

Kegeldiagramm

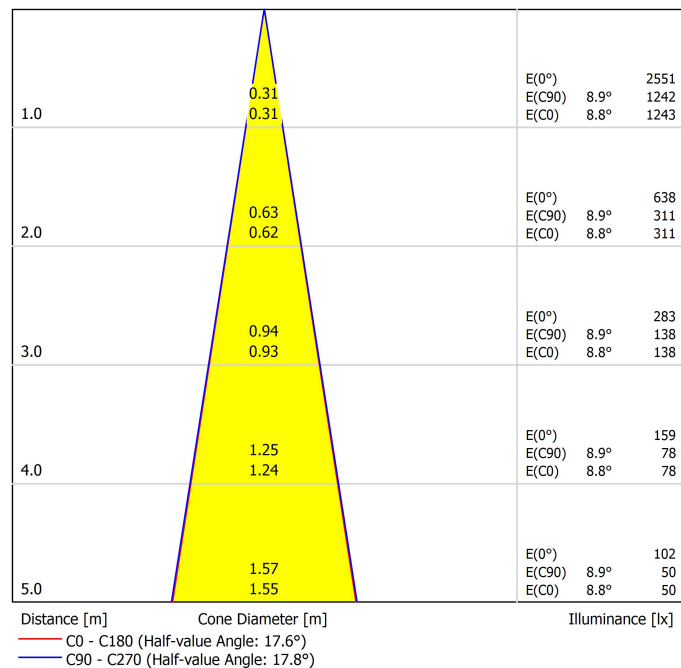

Installationsanleitung



<https://youtu.be/KnedJbKp7oo>



	PRODUCT
Model	Anti-glare Honeycomb Louver
Reference	A3990000
Category	Accessories

WIRD NICHT SEPARAT VERKAUFT. 

Blendschutz-Wabenraster

Zubehörteil mit einem wabenförmigen Raster, das den Lichtstrahl lenkt, Blendung reduziert und die direkte Sicht auf die Lichtquelle verhindert.

Minimal Track

ARKOSLIGHT

Minimal Track is a 24V low-voltage lighting system designed to create minimalist and highly configurable installations. On this page, you'll find the necessary components to configure your surface-mounted system.



Or use our online configurator to design your own custom product layout. The tool will guide you through the process and automatically calculate the required drivers and accessories. [Start your configuration](#) →



Track & accessories - Surface mounting

Configure the shape of your track, add end caps and the required accessories, and finish the setup with the conductive strip (rubber cable).

MINIMAL TRACK 24V

Profile 2m

A384-02-00- | N | WT |



Corner 90° 1 Plane

A384-00-02- | N | WT |

Cable length = 35mm.



End Cap

A384-00-05- | N | WT |



Rubber Cable n x 1m

A384-00-01- | N |

n = Total length of System



Corner 90° 1 Plane Rounded

A384-00-03- | N | WT |

Cable length = 35mm.



Connection Box

A384-00-06- | N | WT |

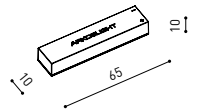

24V | Max. 4A |

Corner 90° 2 Planes

A384-00-04- | N | WT |

Cable length = 100mm.

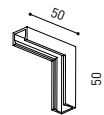

Power Supply

Select your power supply, include a dimmer if needed, and explore the installation diagrams provided.

		P	V	D (A x B x C)
MINIMAL TRACK 24V Power Supply Box	A384-00-07- NT WT	40W	24V	280 x 30 x 24mm
	A384-00-08- NT WT	100W	24V	280 x 30 x 24mm
MINIMAL TRACK 24V Remote Power Supply	0434-01-37	60W	24V	180 x 52 x 30mm
	0433-10-22	100W	24V	295 x 43 x 30mm
220 V ~ 240				
MINIMAL TRACK 24V Remote Constant Voltage Dimmer	0433-01-32	DALI / Push	24V	181 x 42 x 20mm
	0433-01-35	CASAMBI	24V	72,6 x 30 x 18mm
24V	other DIM options please consult			



Connection diagram:



DROP VOLTAGE TABLE

POWER (W)	CABLE SECTION (mm ²)	CABLE LENGTH (m)			
		<5	<10	<20	<30
40	0,75	30	30	30	30
	1,5	30	30	30	30
60	0,75	30	30	20	10
	1,5	30	30	30	20
100	0,75	20	10	X	X
	1,5	20	20	10	X



COLOUR | NT ■ RAL 9005 | WT □ RAL 9016 | N ■ RAL 9005 |

INSTALLATION GUIDE
<https://youtu.be/KnedJbKp7oo>



Minimal Track

ARKOSLIGHT

Minimal Track is a 24V low-voltage lighting system designed to create minimalist and highly configurable installations. On this page, you'll find the necessary components to configure your trimless-mounted system.



Or use our online configurator to design your own custom product layout. The tool will guide you through the process and automatically calculate the required drivers and accessories. [Start your configuration →](#)

Track & accessories - Trimless mounting

Configure the shape of your track, add end caps and the required accessories, and finish the setup with the conductive strip (rubber cable).

MINIMAL TRACK 24V

Trimless Profile 2m

A467-02-00- | N |



Trimless Rubber Cable n x 1m

A467-00-01- | N |



n = Total length of System

24V | Max. 4A |

Trimless Corner 90° 1 Plane

A467-00-02- | N |

Cable length = 140mm.



Trim. Corner 90° 1 Plane Connc.

A467-00-03- | N |



Trimless End Caps

A467-00-05- | N |

Two End Caps Included



Trimless Straight Joiner

A467-00-06

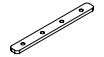

Trimless Connection Box

A467-00-07- | N |

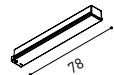

Power Supply

Select your power supply, include a dimmer if needed, and explore the installation diagrams provided.

		P	V	D (A x B x C)
MINIMAL TRACK 24V Remote Power Supply	0434-01-37	60W	24V	180 x 52 x 30mm
	0433-10-22	100W	24V	295 x 43 x 30mm

220 V ~
240

			V	D (A x B x C)
MINIMAL TRACK 24V Remote Constant Voltage Dimmer	0433-01-32	DALI / Push	24V	181 x 42 x 20mm
	0433-01-35	CASAMBI	24V	72,6 x 30 x 18mm

24V | other DIM options please consult



Connection diagram:



DROP VOLTAGE TABLE

POWER (W)	CABLE SECTION (mm ²)	CABLE LENGTH (m)			
		<5	<10	<20	<30
40	0,75	30	30	30	30
	1,5	30	30	30	30
60	0,75	30	30	20	10
	1,5	30	30	30	20
100	0,75	20	10	X	X
	1,5	20	20	10	X

Reduce 5 meters per each 'Corner 90° 1 Plane CONNECTOR' used.



COLOUR | NT ■ RAL 9005 | WT □ RAL 9016 | N ■ RAL 9005 |

INSTALLATION GUIDE
<https://youtu.be/KnedJbKp7oo>



Minimal Track

ARKOSLIGHT

Minimal Track is a 24V low-voltage lighting system designed to create minimalist and highly configurable installations. On this page, you'll find the necessary components to configure your suspension-mounted system.



Or use our online configurator to design your own custom product layout. The tool will guide you through the process and automatically calculate the required drivers and accessories. [Start your configuration →](#)



Track & accessories - Suspension mounting

Configure the shape of your track, add end caps and the required accessories, and finish the setup with the conductive strip (rubber cable).

MINIMAL TRACK 24V Suspension

Profile 2m
A384-02-00- | N | WT |

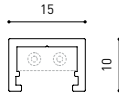

Rubber Cable n x 1m
A384-00-01- | N |

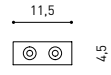

Suspension Straight Joiner
A400-00-02- | N | WT |



Profile 2m Initial feed kit
A400-02-10- | N | WT |



24 V | Max. 4A | III



Suspension Kit
A400-02-04- | N | WT |

Max distance between suspension kits = 100 cm.

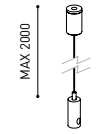

Profile 2m Middle feed kit*
A400-02-20- | N | WT |

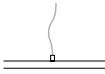

Corner 90°
A400-00-03- | N | WT |

Cable length = 85mm.

Suspension End Caps
A400-00-05- | N | WT |

Two End Caps Included.



* Unidirectional Middle Feed.

Power Supply

Select your power supply, include a dimmer if needed, and explore the installation diagrams provided.

		P	V	D (A x B x C)	
MINIMAL TRACK 24V Susp Power Supply Box	NO DIM	A400-00-06- NT WT	40W	24V	280 x 30 x 36mm
		A400-00-07- NT WT	100W	24V	280 x 30 x 36mm
MINIMAL TRACK 24V Remote Power Supply	NO DIM	0434-01-37	60W	24V	180 x 52 x 30mm
		0433-10-22	100W	24V	295 x 43 x 30mm

220 V~
240

MINIMAL TRACK 24V Remote Constant Voltage Dimmer		0433-01-32	DALI / Push	24V	181 x 42 x 20mm
		0433-01-35	CASAMBI	24V	72,6 x 30 x 18mm

24V | other DIM options please consult

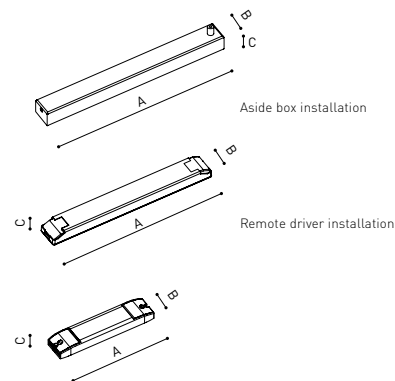

Connection diagram:



DROP VOLTAGE TABLE

POWER (W)	CABLE SECTION (mm ²)	CABLE LENGTH (m)			
		<5	<10	<20	<30
40	0,75	30	30	30	30
	1,5	30	30	30	30
60	0,75	30	30	20	10
	1,5	30	30	30	20
100	0,75	20	10	X	X
	1,5	20	20	10	X

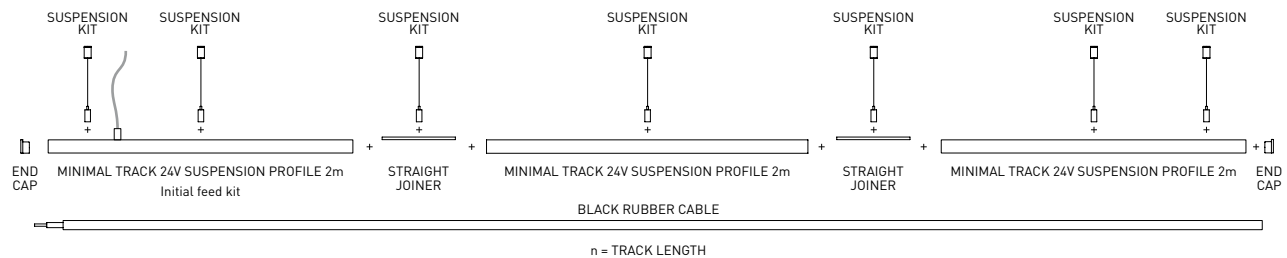

COLOUR | NT ■ RAL 9005 | WT □ RAL 9016 | N ■ RAL 9005 |





	PRODUCT
Model	Coaxial Trimless
Reference	A023-00-03- W N
Colour	W <input type="checkbox"/> RAL 9016 N <input type="checkbox"/> RAL 9005
Category	Accessories



Dimensional drawing



Zubehör für trimless Kabel

Wire Trimless Accessory umfasst eine Reihe von Zubehörteilen, um Spanner und Kabel der Arkoslight Pendelleuchten direkt an der Decke ohne sichtbare Deckendosen oder Befestigungselemente zu installieren. Dadurch wird eine minimalistische und optisch saubere Umsetzung im Raum erzielt.

Mit Wire Trimless Accessory werden die an der Decke anliegenden Elemente des Standardprodukts (Deckendosen, Befestigungselemente, Treiberboxen...) durch eine einfache Einbauanwendung verborgen.

Wire Trimless Accessory sorgt für unauffällige Installation und eine äußerst minimalistische Ästhetik. Die Kabel kommen als Teil der Struktur aus der Decke. Dieses Detail sorgt für ein besonders nüchternes und essentielles Erscheinungsbild, insbesondere bei Kombinationen von mehreren Elementen.



INSTALLATION GUIDE

https://youtu.be/sa_xAgj4ji4



PRODUCT

Model	Trimless Tool D20 X D52 MM
Reference	A478-00-01
Category	Accessories



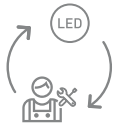

Fuente de luz (LED) reemplazable por un profesional autorizado

Replaceable (LED only) light source by an authorized professional.

Source lumineuse (LED) remplaçable par un professionnel agréé

Sorgente luminosa (LED) sostituibile da parte di un professionista autorizzato

Austauschbare (LED) Lichtquelle durch einen autorisierten Fachmann



Equipo de control reemplazable por un profesional autorizado

Replaceable control gear by an authorized professional

Dispositif de commande remplaçable par un professionnel agréé

Alimentatore sostituibile da parte di un professionista autorizzato

Auswechselbares Betriebsgerät durch autorisierten Fachmann

Instrucciones para el final de vida y la eliminación de los componentes:

Instructions on end-of-life and component disposal:

Instructions pour la gestion des composants en fin de vie et leur mise au rebut :

Istruzioni per il fine vita e lo smaltimento dei componenti:

Anweisungen zur entsorgung der Leuchtenkomponenten:



Interrumpir la alimentación del aparato
Cut the power supply to the luminaire
Couper l'alimentation du luminaire
Interrompere l'alimentazione dell'apparecchio
Stromversorgung der Leuchte unterbrechen



Quitar la(s) fuente(s) de luz para el desecho
Remove light source(s) for disposal
Retirer la (les) source(s) lumineuse(s) pour l'élimination
Rimuovere la/le sorgente/e di luce per lo smaltimento
Lichtquelle(n) zur Entsorgung entfernen



Quitar la batería para el desecho
Remove the battery for decommissioning
Retirer la batterie pour sa mise au rebut
Rimuovere la batteria per la dismissione
Die Batterie ordnungsgemäß entsorgen



Quitar el equipo de control para el desecho
Remove control gear for disposal
Retirer le dispositif de commande pour l'élimination
Rimuovere l'alimentatore per lo smaltimento
Betriebsgerät zur Entsorgung ausbauen



Enviar los materiales a un centro de recogida RAEE
Send the materials to a WEEE collection centre
Envoyer les matériaux dans une déchetterie DEEE
Inviare i materiali ad un centro di raccolta RAEE
Die Materialien in einem WEEE-Zentrum entsorgen

