

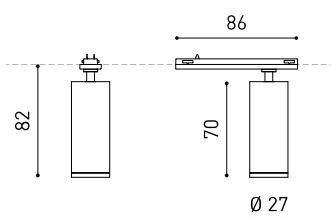

## Größe



## Zubehör



HONEYCOMB LOUVER



MINIMAL TRACK OPTIONS

## Preise



reddot winner 2020  
innovative product  
& lighting design



Bronze Delta  
ADI Awards 2020



HONORABLE MENTION  
EUROPEAN  
PRODUCT  
DESIGN  
AWARD



WINNER  
2020



archiproducts  
DESIGN AWARDS  
WINNER 2020



ORO

## PRODUKT

Name	FIT 27 24V 1 FLOOD 3000K NT
Artikelnummer	A3990031NT
Farbe	Schwarz strukturiert
RAL	9005
Kategorie	TRACK LIGHTS

## LICHTQUELLE

Typ	LED
Bruttolichtstrom	470 lm
Farbtemperatur	3000 K
Farbstabilität	MacAdam Step 2
Farbwiedergabeindex	CRI>90
Leistung	4,5 W
Stromstärke	400 mA
Lichtausbeute	104 lm/W
Nutzlebensdauer der LED in Betriebsstunden	L90B10 >108.000h
Energieeffizienzklasse	F

## LEUCHTE | PHOTOMETRISCHE DATEN

Leuchtenwirkungsgrad (LOR)	84%
Abstrahlwinkel	42°

## LEUCHTE | ELEKTRISCHE DATEN

Leistungswerte des Systems	5,14 W
Spannung	24Vdc
Helligkeitssteuerung	DIM-Optionen
Schutzklasse	III

## ANDERE DATEN

Dichtigkeit	IP20
Wireless control	Bitte anfragen
Schwenkwinkel	90°
Drehwinkel	355°
Schiementyp	Minimal Track
Gewicht	75 g
Gewicht inkl. Verpackung	115 g
Abmessungen der Verpackung	113 x 111 x 32 mm
Stück pro Verpackung	1
Materialien	Aluminium / Polycarbonat



Fit 27 24V ist ein Strahler für das Minimal Track System. Die zylindrische Geometrie und die wesentlichen Formen zeichnen sich durch ästhetischen Minimalismus und Funktionalität aus, da sie in alle Richtungen ausgerichtet werden können. Der Umfang des Randes in Schwarz betont seine blendfreie Berufung.

## Polar-kordinaten diagramm



## Kegeldiagramm

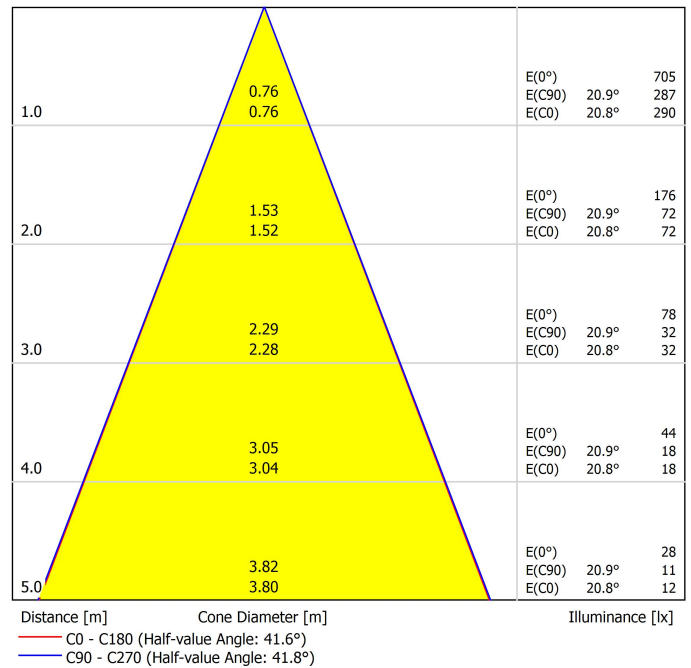

## Installationsanleitung



<https://youtu.be/KnedJbKp7oo>



	PRODUCT
Model	Anti-glare Honeycomb Louver
Reference	A3990000
Category	Accessories

WIRD NICHT SEPARAT VERKAUFT.



## Blendschutz-Wabenraster

Zubehörteil mit einem wabenförmigen Raster, das den Lichtstrahl lenkt, Blendung reduziert und die direkte Sicht auf die Lichtquelle verhindert.

# Minimal Track

# ARKOSLIGHT

Minimal Track is a 24V low-voltage lighting system designed to create minimalist and highly configurable installations. On this page, you'll find the necessary components to configure your surface-mounted system.



Or use our online configurator to design your own custom product layout. The tool will guide you through the process and automatically calculate the required drivers and accessories. [Start your configuration →](#)



## Track & accessories - Surface mounting

Configure the shape of your track, add end caps and the required accessories, and finish the setup with the conductive strip (rubber cable).

### MINIMAL TRACK 24V

#### Profile 2m

A384-02-00- | N | WT |



#### Corner 90° 1 Plane

A384-00-02- | N | WT |

Cable length = 35mm.



#### End Cap

A384-00-05- | N | WT |



#### Rubber Cable n x 1m

A384-00-01- | N |

n = Total length of System



#### Corner 90° 1 Plane Rounded

A384-00-03- | N | WT |

Cable length = 35mm.



#### Connection Box

A384-00-06- | N | WT |



24V | Max. 4A | III

#### Corner 90° 2 Planes

A384-00-04- | N | WT |

Cable length = 100mm.

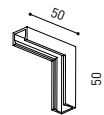

## Power Supply

Select your power supply, include a dimmer if needed, and explore the installation diagrams provided.

		P	V	D (A x B x C)
MINIMAL TRACK 24V Power Supply Box	NO DIM	A384-00-07-   NT   WT	40W	24V 280 x 30 x 24mm
		A384-00-08-   NT   WT	100W	24V 280 x 30 x 24mm
MINIMAL TRACK 24V Remote Power Supply	NO DIM	0434-01-37	60W	24V 180 x 52 x 30mm
		0433-10-22	100W	24V 295 x 43 x 30mm
MINIMAL TRACK 24V Remote Constant Voltage Dimmer		0433-01-32	DALI / Push	24V 181 x 42 x 20mm
		0433-01-35	CASAMBI	24V 72,6 x 30 x 18mm

220 V~  
240 V~

24V | other DIM options please consult



## Connection diagram:

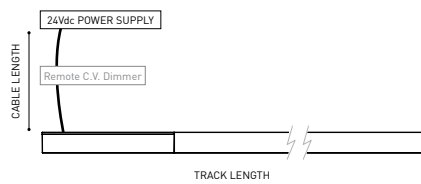

### DROP VOLTAGE TABLE

POWER (W)	CABLE SECTION (mm <sup>2</sup> )	CABLE LENGTH (m)			
		<5	<10	<20	<30
40	0,75	30	30	30	30
	1,5	30	30	30	30
60	0,75	30	30	20	10
	1,5	30	30	30	20
100	0,75	20	10	X	X
	1,5	20	20	10	X



COLOUR | NT ■ RAL 9005 | WT □ RAL 9016 | N ■ RAL 9005 |

INSTALLATION GUIDE  
<https://youtu.be/KnedJbKp7oo>



# Minimal Track

# ARKOSLIGHT

Minimal Track is a 24V low-voltage lighting system designed to create minimalist and highly configurable installations. On this page, you'll find the necessary components to configure your trimless-mounted system.



Or use our online configurator to design your own custom product layout. The tool will guide you through the process and automatically calculate the required drivers and accessories. [Start your configuration →](#)

## Track & accessories - Trimless mounting

Configure the shape of your track, add end caps and the required accessories, and finish the setup with the conductive strip (rubber cable).

### MINIMAL TRACK 24V

#### Trimless Profile 2m

A467-02-00- | N |



#### Trimless Rubber Cable n x 1m

A467-00-01- | N |

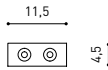

n = Total length of System

24 V | Max. 4A |

#### Trimless Corner 90° 1 Plane

A467-00-02- | N |

Cable length = 140mm.



#### Trimless Corner 90° 2 Planes

A467-00-04- | N |

Cable length = 200mm.

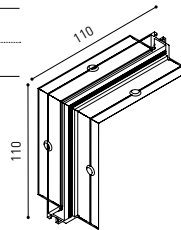

#### Trim. Corner 90° 1 Plane Connc.

A467-00-03- | N |



#### Trimless End Caps

A467-00-05- | N |

Two End Caps Included



#### Trimless Straight Joiner

A467-00-06



#### Trimless Connection Box

A467-00-07- | N |



## Power Supply

Select your power supply, include a dimmer if needed, and explore the installation diagrams provided.

		P	V	D (A x B x C)
MINIMAL TRACK 24V Remote Power Supply	0434-01-37	60W	24V	180 x 52 x 30mm
	0433-10-22	100W	24V	295 x 43 x 30mm

220 V ~  
240

			V	D (A x B x C)
MINIMAL TRACK 24V Remote Constant Voltage Dimmer	0433-01-32	DALI / Push	24V	181 x 42 x 20mm
	0433-01-35	CASAMBI	24V	72,6 x 30 x 18mm

24V | other DIM options please consult

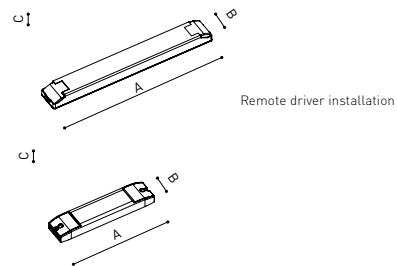

## Connection diagram:



### DROP VOLTAGE TABLE

POWER (W)	CABLE SECTION (mm <sup>2</sup> )	CABLE LENGTH (m)			
		<5	<10	<20	<30
40	0,75	30	30	30	30
	1,5	30	30	30	30
60	0,75	30	30	20	10
	1,5	30	30	30	20
100	0,75	20	10	X	X
	1,5	20	20	10	X

Reduce 5 meters per each 'Corner 90° 1 Plane CONNECTOR' used.



COLOUR | NT ■ RAL 9005 | WT □ RAL 9016 | N ■ RAL 9005 |

INSTALLATION GUIDE  
<https://youtu.be/KnedJbKp7oo>



# Minimal Track

# ARKOSLIGHT

Minimal Track is a 24V low-voltage lighting system designed to create minimalist and highly configurable installations. On this page, you'll find the necessary components to configure your suspension-mounted system.



Or use our online configurator to design your own custom product layout. The tool will guide you through the process and automatically calculate the required drivers and accessories. [Start your configuration →](#)



## Track & accessories - Suspension mounting

Configure the shape of your track, add end caps and the required accessories, and finish the setup with the conductive strip (rubber cable).

### MINIMAL TRACK 24V Suspension

#### Profile 2m

A384-02-00- | N | WT |



#### Rubber Cable n x 1m

A384-00-01- | N |

n = Total length of System

24V | Max. 4A | III



#### Suspension Straight Joiner

A400-00-02- | N | WT |



#### Profile 2m Initial feed kit

A400-02-10- | N | WT |



#### Suspension Kit

A400-02-04- | N | WT |

Max distance between suspension kits = 100 cm.

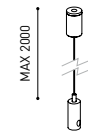

#### Profile 2m Middle feed kit\*

A400-02-20- | N | WT |



#### Corner 90°

A400-00-03- | N | WT |



Cable length = 85mm.

#### Suspension End Caps

A400-00-05- | N | WT |

Two End Caps Included.



\* Unidirectional Middle Feed.

## Power Supply

Select your power supply, include a dimmer if needed, and explore the installation diagrams provided.

		P	V	D (A x B x C)	
MINIMAL TRACK 24V Susp Power Supply Box	NO DIM	A400-00-06-   NT   WT	40W	24V	280 x 30 x 36mm
		A400-00-07-   NT   WT	100W	24V	280 x 30 x 36mm
MINIMAL TRACK 24V Remote Power Supply	NO DIM	0434-01-37	60W	24V	180 x 52 x 30mm
		0433-10-22	100W	24V	295 x 43 x 30mm

220V-  
240V

MINIMAL TRACK 24V Remote Constant Voltage Dimmer				
	0433-01-32	DALI / Push	24V	181 x 42 x 20mm
	0433-01-35	CASAMBI	24V	72,6 x 30 x 18mm

24V | other DIM options please consult

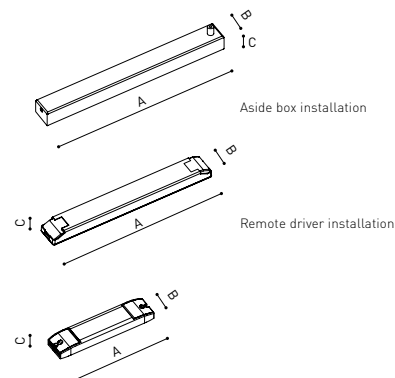

## Connection diagram:

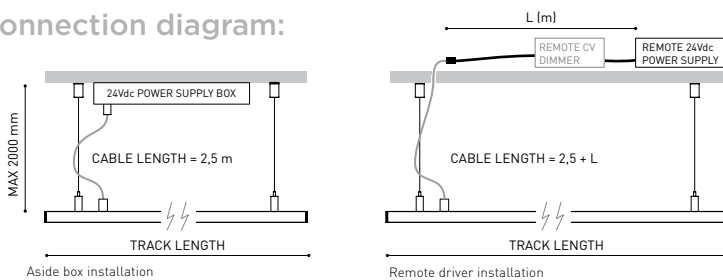

### DROP VOLTAGE TABLE

POWER (W)	CABLE SECTION (mm <sup>2</sup> )	CABLE LENGTH (m)			
		<5	<10	<20	<30
40	0,75	30	30	30	30
	1,5	30	30	30	30
60	0,75	30	30	20	10
	1,5	30	30	30	20
100	0,75	20	10	X	X
	1,5	20	20	10	X

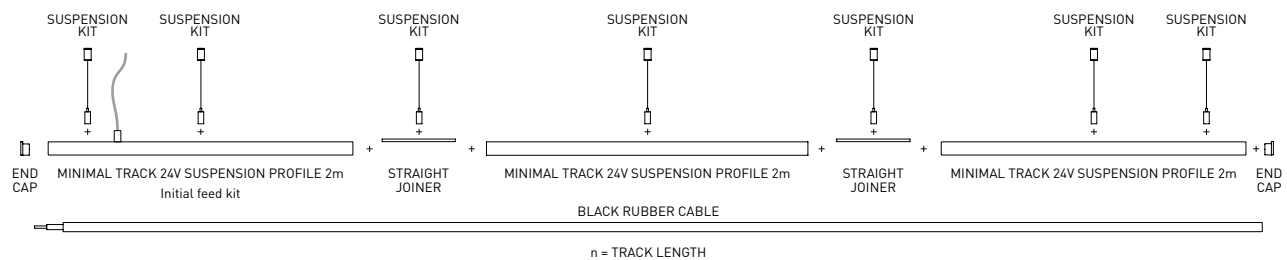

COLOUR | NT ■ RAL 9005 | WT □ RAL 9016 | N ■ RAL 9005 |



	PRODUCT
Model	Coaxial Trimless
Reference	A023-00-03-   W   N
Colour	W <input type="checkbox"/> RAL 9016   N <input type="checkbox"/> RAL 9005
Category	Accessories



### Dimensional drawing

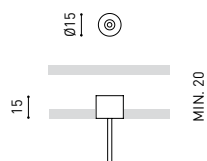

#### Zubehör für trimless Kabel

Wire Trimless Accessory umfasst eine Reihe von Zubehörteilen, um Spanner und Kabel der Arkoslight Pendelleuchten direkt an der Decke ohne sichtbare Deckendosen oder Befestigungselemente zu installieren. Dadurch wird eine minimalistische und optisch saubere Umsetzung im Raum erzielt.

Mit Wire Trimless Accessory werden die an der Decke anliegenden Elemente des Standardprodukts (Deckendosen, Befestigungselemente, Treiberboxen...) durch eine einfache Einbauanwendung verborgen.

Wire Trimless Accessory sorgt für unauffällige Installation und eine äußerst minimalistische Ästhetik. Die Kabel kommen als Teil der Struktur aus der Decke. Dieses Detail sorgt für ein besonders nüchternes und essentielles Erscheinungsbild, insbesondere bei Kombinationen von mehreren Elementen.



INSTALLATION GUIDE

[https://youtu.be/sa\\_xAgj4ji4](https://youtu.be/sa_xAgj4ji4)



#### PRODUCT

Model	Trimless Tool <b>D20 X D52 MM</b>
Reference	A478-00-01
Category	Accessories





Fuente de luz (LED) reemplazable por un profesional autorizado  
 Replaceable (LED only) light source by an authorized professional.  
 Source lumineuse (LED) remplaçable par un professionnel agréé  
 Sorgente luminosa (LED) sostituibile da parte di un professionista autorizzato  
 Austauschbare (LED) Lichtquelle durch einen autorisierten Fachmann



Equipo de control reemplazable por un profesional autorizado  
 Replaceable control gear by an authorized professional  
 Dispositif de commande remplaçable par un professionnel agréé  
 Alimentatore sostituibile da parte di un professionista autorizzato  
 Auswechselbares Betriebsgerät durch autorisierten Fachmann

## Instrucciones para el final de vida y la eliminación de los componentes:

### Instructions on end-of-life and component disposal:

### Instructions pour la gestion des composants en fin de vie et leur mise au rebut :

### Istruzioni per il fine vita e lo smaltimento dei componenti:

### Anweisungen zur entsorgung der Leuchtenkomponenten:



Interrumpir la alimentación del aparato  
 Cut the power supply to the luminaire  
 Couper l'alimentation du luminaire  
 Interrompere l'alimentazione dell'apparecchio  
 Stromversorgung der Leuchte unterbrechen



Quitar la(s) fuente(s) de luz para el desecho  
 Remove light source(s) for disposal  
 Retirer la (les) source(s) lumineuse(s) pour l'élimination  
 Rimuovere la/le sorgente/e di luce per lo smaltimento  
 Lichtquelle(n) zur Entsorgung entfernen



Quitar la batería para el desecho  
 Remove the battery for decommissioning  
 Retirer la batterie pour sa mise au rebut  
 Rimuovere la batteria per la dismissione  
 Die Batterie ordnungsgemäß entsorgen



Quitar el equipo de control para el desecho  
 Remove control gear for disposal  
 Retirer le dispositif de commande pour l'élimination  
 Rimuovere l'alimentatore per lo smaltimento  
 Betriebsgerät zur Entsorgung ausbauen



Enviar los materiales a un centro de recogida RAEE  
 Send the materials to a WEEE collection centre  
 Envoyer les matériaux dans une déchetterie DEEE  
 Inviare i materiali ad un centro di raccolta RAEE  
 Die Materialien in einem WEEE-Zentrum entsorgen

