

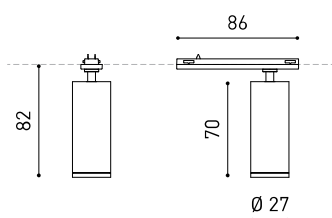

## Größe



## Zubehör



HONEYCOMB LOUVER



MINIMAL TRACK OPTIONS

## Preise



reddot winner 2020  
innovative product  
& lighting design



Bronze Delta  
ADI Awards 2020



EUROPEAN  
PRODUCT  
DESIGN  
AWARD



WINNER  
2020



archiproducts  
DESIGN AWARDS  
WINNER 2020



ORO

## PRODUKT

|               |                            |
|---------------|----------------------------|
| Name          | FIT 27 24V 2 SPOT 3000K WT |
| Artikelnummer | A3991011WT                 |
| Farbe         | Weiß strukturiert          |
| RAL           | 9016                       |
| Kategorie     | TRACK LIGHTS               |

## LICHTQUELLE

|  |                  |
|--|------------------|
| Typ  | LED              |
| Bruttolichtstrom                           | 560 lm           |
| Farbtemperatur                             | 3000 K           |
| Farbstabilität                             | MacAdam Step 2   |
| Farbwiedergabeindex                        | CRI>90           |
| Leistung                                   | 5,5 W            |
| Stromstärke                                | 500 mA           |
| Lichtausbeute                              | 102 lm/W         |
| Nutzlebensdauer der LED in Betriebsstunden | L90B10 >108.000h |
| Energieeffizienzklasse                     | F                |

## LEUCHTE | PHOTOMETRISCHE DATEN

|                            |     |
|----------------------------|-----|
| Leuchtenwirkungsgrad (LOR) | 84% |
| Abstrahlwinkel             | 18° |

## LEUCHTE | ELEKTRISCHE DATEN

|                            |              |
|----------------------------|--------------|
| Leistungswerte des Systems | 6,34 W       |
| Spannung                   | 24Vdc        |
| Helligkeitssteuerung       | DIM-Optionen |
| Schutzklasse               | III          |

## ANDERE DATEN

|                            |                          |
|----------------------------|--------------------------|
| Dichtigkeit                | IP20                     |
| Wireless control           | Bitte anfragen           |
| Schwenkwinkel              | 90°                      |
| Drehwinkel                 | 355°                     |
| Schiementyp                | Minimal Track            |
| Gewicht                    | 75 g                     |
| Gewicht inkl. Verpackung   | 115 g                    |
| Abmessungen der Verpackung | 113 x 111 x 32 mm        |
| Stück pro Verpackung       | 1                        |
| Materialien                | Aluminium / Polycarbonat |



Fit 27 24V ist ein Strahler für das Minimal Track System. Die zylindrische Geometrie und die wesentlichen Formen zeichnen sich durch ästhetischen Minimalismus und Funktionalität aus, da sie in alle Richtungen ausgerichtet werden können. Der Umfang des Randes in Schwarz betont seine blendfreie Berufung.

## Polar-kordinaten diagramm

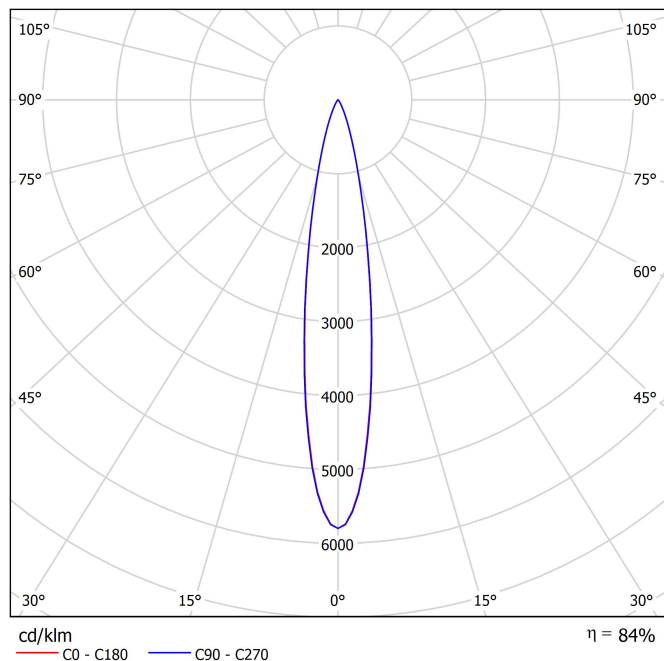

## Kegeldiagramm

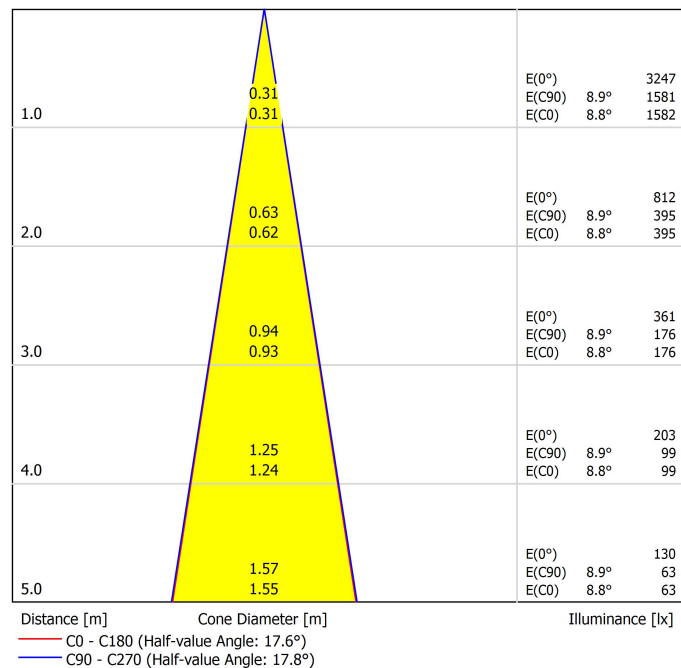

## Installationsanleitung



<https://youtu.be/KnedJbKp7oo>



|           | PRODUCT                     |
|-----------|-----------------------------|
| Model     | Anti-glare Honeycomb Louver |
| Reference | A3990000                    |
| Category  | Accessories                 |

WIRD NICHT SEPARAT VERKAUFT. 

## Blendschutz-Wabenraster

Zubehörteil mit einem wabenförmigen Raster, das den Lichtstrahl lenkt, Blendung reduziert und die direkte Sicht auf die Lichtquelle verhindert.

# Minimal Track

# ARKOSLIGHT

Minimal Track is a 24V low-voltage lighting system designed to create minimalist and highly configurable installations. On this page, you'll find the necessary components to configure your surface-mounted system.



Or use our online configurator to design your own custom product layout. The tool will guide you through the process and automatically calculate the required drivers and accessories. [Start your configuration →](#)



## Track & accessories - Surface mounting

Configure the shape of your track, add end caps and the required accessories, and finish the setup with the conductive strip (rubber cable).

### MINIMAL TRACK 24V

#### Profile 2m

A384-02-00- | N | WT |



#### Corner 90° 1 Plane

A384-00-02- | N | WT |

Cable length = 35mm.



#### End Cap

A384-00-05- | N | WT |



#### Rubber Cable n x 1m

A384-00-01- | N |

n = Total length of System



#### Corner 90° 1 Plane Rounded

A384-00-03- | N | WT |

Cable length = 35mm.



#### Connection Box

A384-00-06- | N | WT |



24V | Max. 4A | III

#### Corner 90° 2 Planes

A384-00-04- | N | WT |

Cable length = 100mm.

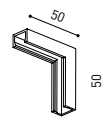

## Power Supply

Select your power supply, include a dimmer if needed, and explore the installation diagrams provided.

|   |        | P                     | V           | D (A x B x C)        |
|---|--------|-----------------------|-------------|----------------------|
| MINIMAL TRACK 24V<br>Power Supply Box               | NO DIM | A384-00-07-   NT   WT | 40W         | 24V 280 x 30 x 24mm  |
|   |        | A384-00-08-   NT   WT | 100W        | 24V 280 x 30 x 24mm  |
| MINIMAL TRACK 24V<br>Remote Power Supply            | NO DIM | 0434-01-37            | 60W         | 24V 180 x 52 x 30mm  |
|   |        | 0433-10-22            | 100W        | 24V 295 x 43 x 30mm  |
| MINIMAL TRACK 24V<br>Remote Constant Voltage Dimmer |        | 0433-01-32            | DALI / Push | 24V 181 x 42 x 20mm  |
|   |        | 0433-01-35            | CASAMBI     | 24V 72,6 x 30 x 18mm |

220 V~  
240 V~

24V | other DIM options please consult



## Connection diagram:



### DROP VOLTAGE TABLE

| POWER (W) | CABLE SECTION (mm <sup>2</sup> ) | CABLE LENGTH (m) |     |     |     |
|-----------|----------------------------------|------------------|-----|-----|-----|
|           |                                  | <5               | <10 | <20 | <30 |
| 40        | 0,75                             | 30               | 30  | 30  | 30  |
|           | 1,5                              | 30               | 30  | 30  | 30  |
| 60        | 0,75                             | 30               | 30  | 20  | 10  |
|           | 1,5                              | 30               | 30  | 30  | 20  |
| 100       | 0,75                             | 20               | 10  | X   | X   |
|           | 1,5                              | 20               | 20  | 10  | X   |

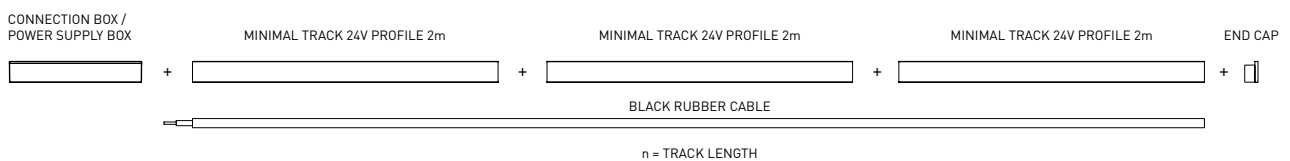

COLOUR | NT ■ RAL 9005 | WT □ RAL 9016 | N ■ RAL 9005 |

INSTALLATION GUIDE  
<https://youtu.be/KnedJbKp7oo>



# Minimal Track

# ARKOSLIGHT

Minimal Track is a 24V low-voltage lighting system designed to create minimalist and highly configurable installations. On this page, you'll find the necessary components to configure your trimless-mounted system.



Or use our online configurator to design your own custom product layout. The tool will guide you through the process and automatically calculate the required drivers and accessories. [Start your configuration →](#)

## Track & accessories - Trimless mounting

Configure the shape of your track, add end caps and the required accessories, and finish the setup with the conductive strip (rubber cable).

### MINIMAL TRACK 24V

#### Trimless Profile 2m

A467-02-00- | N |



#### Trimless Rubber Cable n x 1m

A467-00-01- | N |

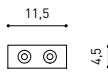

n = Total length of System

24V | Max. 4A |

#### Trimless Corner 90° 1 Plane

A467-00-02- | N |

Cable length = 140mm.



#### Trimless Corner 90° 2 Planes

A467-00-04- | N |

Cable length = 200mm.



#### Trim. Corner 90° 1 Plane Connc.

A467-00-03- | N |



#### Trimless End Caps

A467-00-05- | N |

Two End Caps Included



#### Trimless Straight Joiner

A467-00-06



#### Trimless Connection Box

A467-00-07- | N |



## Power Supply

Select your power supply, include a dimmer if needed, and explore the installation diagrams provided.

|                                       |            | P    | V   | D (A x B x C)   |
|---------------------------------------|------------|------|-----|-----------------|
| MINIMAL TRACK 24V Remote Power Supply | 0434-01-37 | 60W  | 24V | 180 x 52 x 30mm |
|                                       | 0433-10-22 | 100W | 24V | 295 x 43 x 30mm |

220 V ~  
240

|  |            |             | V   | D (A x B x C)    |
|--|------------|-------------|-----|------------------|
| MINIMAL TRACK 24V Remote Constant Voltage Dimmer | 0433-01-32 | DALI / Push | 24V | 181 x 42 x 20mm  |
|  | 0433-01-35 | CASAMBI     | 24V | 72,6 x 30 x 18mm |

24V | other DIM options please consult



## Connection diagram:



### DROP VOLTAGE TABLE

| POWER (W) | CABLE SECTION (mm <sup>2</sup> ) | CABLE LENGTH (m) |     |     |     |
|-----------|----------------------------------|------------------|-----|-----|-----|
|           |                                  | <5               | <10 | <20 | <30 |
| 40        | 0,75                             | 30               | 30  | 30  | 30  |
|           | 1,5                              | 30               | 30  | 30  | 30  |
| 60        | 0,75                             | 30               | 30  | 20  | 10  |
|           | 1,5                              | 30               | 30  | 30  | 20  |
| 100       | 0,75                             | 20               | 10  | X   | X   |
|           | 1,5                              | 20               | 20  | 10  | X   |

Reduce 5 meters per each 'Corner 90° 1 Plane CONNECTOR' used.



COLOUR | NT ■ RAL 9005 | WT □ RAL 9016 | N ■ RAL 9005 |

INSTALLATION GUIDE  
<https://youtu.be/KnedJbKp7oo>



# Minimal Track

# ARKOSLIGHT

Minimal Track is a 24V low-voltage lighting system designed to create minimalist and highly configurable installations. On this page, you'll find the necessary components to configure your suspension-mounted system.



Or use our online configurator to design your own custom product layout. The tool will guide you through the process and automatically calculate the required drivers and accessories. [Start your configuration →](#)



## Track & accessories - Suspension mounting

Configure the shape of your track, add end caps and the required accessories, and finish the setup with the conductive strip (rubber cable).

### MINIMAL TRACK 24V Suspension

**Profile 2m**  
A384-02-00- | N | WT |

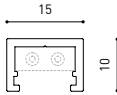

**Rubber Cable n x 1m**  
A384-00-01- | N |

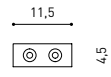

**Suspension Straight Joiner**  
A400-00-02- | N | WT |



**Profile 2m Initial feed kit**  
A400-02-10- | N | WT |



24 V | Max. 4A | III



**Suspension Kit**  
A400-02-04- | N | WT |

Max distance between suspension kits = 100 cm.

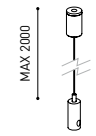

**Profile 2m Middle feed kit\***  
A400-02-20- | N | WT |

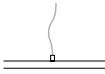

**Corner 90°**  
A400-00-03- | N | WT |

Cable length = 85mm.

**Suspension End Caps**  
A400-00-05- | N | WT |

Two End Caps Included.



\* Unidirectional Middle Feed.

## Power Supply

Select your power supply, include a dimmer if needed, and explore the installation diagrams provided.

|  |        | P                     | V    | D (A x B x C) |                 |
|--|--------|-----------------------|------|---------------|-----------------|
| MINIMAL TRACK 24V<br>Susp Power Supply Box | NO DIM | A400-00-06-   NT   WT | 40W  | 24V           | 280 x 30 x 36mm |
|  |        | A400-00-07-   NT   WT | 100W | 24V           | 280 x 30 x 36mm |
| MINIMAL TRACK 24V<br>Remote Power Supply   | NO DIM | 0434-01-37            | 60W  | 24V           | 180 x 52 x 30mm |
|  |        | 0433-10-22            | 100W | 24V           | 295 x 43 x 30mm |

220 V~  
240

| MINIMAL TRACK 24V<br>Remote Constant<br>Voltage Dimmer |  | 0433-01-32 | DALI / Push | 24V | 181 x 42 x 20mm  |
|--|--|------------|-------------|-----|------------------|
|  |  | 0433-01-35 | CASAMBI     | 24V | 72,6 x 30 x 18mm |

24V | other DIM options please consult

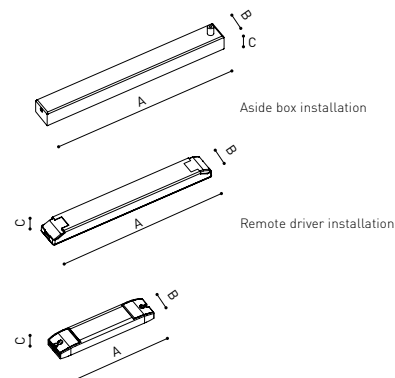

## Connection diagram:

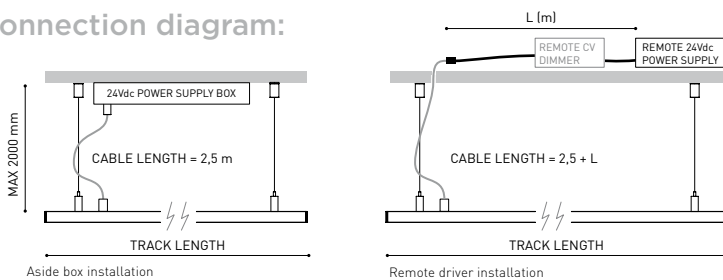

### DROP VOLTAGE TABLE

| POWER (W) | CABLE SECTION (mm <sup>2</sup> ) | CABLE LENGTH (m) |     |     |     |
|-----------|----------------------------------|------------------|-----|-----|-----|
|           |                                  | <5               | <10 | <20 | <30 |
| 40        | 0,75                             | 30               | 30  | 30  | 30  |
|           | 1,5                              | 30               | 30  | 30  | 30  |
| 60        | 0,75                             | 30               | 30  | 20  | 10  |
|           | 1,5                              | 30               | 30  | 30  | 20  |
| 100       | 0,75                             | 20               | 10  | X   | X   |
|           | 1,5                              | 20               | 20  | 10  | X   |



COLOUR | NT ■ RAL 9005 | WT □ RAL 9016 | N ■ RAL 9005 |



|           | PRODUCT   |
|-----------|---|
| Model     | Coaxial Trimless  |
| Reference | A023-00-03-   W   N   |
| Colour    | W <input type="checkbox"/> RAL 9016   N <input type="checkbox"/> RAL 9005 |
| Category  | Accessories   |



### Dimensional drawing



#### Zubehör für trimless Kabel

Wire Trimless Accessory umfasst eine Reihe von Zubehörteilen, um Spanner und Kabel der Arkoslight Pendelleuchten direkt an der Decke ohne sichtbare Deckendosen oder Befestigungselemente zu installieren. Dadurch wird eine minimalistische und optisch saubere Umsetzung im Raum erzielt.

Mit Wire Trimless Accessory werden die an der Decke anliegenden Elemente des Standardprodukts (Deckendosen, Befestigungselemente, Treiberboxen...) durch eine einfache Einbauanwendung verborgen.

Wire Trimless Accessory sorgt für unauffällige Installation und eine äußerst minimalistische Ästhetik. Die Kabel kommen als Teil der Struktur aus der Decke. Dieses Detail sorgt für ein besonders nüchternes und essentielles Erscheinungsbild, insbesondere bei Kombinationen von mehreren Elementen.



INSTALLATION GUIDE

[https://youtu.be/sa\\_xAgj4ji4](https://youtu.be/sa_xAgj4ji4)



#### PRODUCT

|           |                                   |
|-----------|-----------------------------------|
| Model     | Trimless Tool <b>D20 X D52 MM</b> |
| Reference | A478-00-01                        |
| Category  | Accessories                       |





Fuente de luz (LED) reemplazable por un profesional autorizado  
 Replaceable (LED only) light source by an authorized professional.  
 Source lumineuse (LED) remplaçable par un professionnel agréé  
 Sorgente luminosa (LED) sostituibile da parte di un professionista autorizzato  
 Austauschbare (LED) Lichtquelle durch einen autorisierten Fachmann



Equipo de control reemplazable por un profesional autorizado  
 Replaceable control gear by an authorized professional  
 Dispositif de commande remplaçable par un professionnel agréé  
 Alimentatore sostituibile da parte di un professionista autorizzato  
 Auswechselbares Betriebsgerät durch autorisierten Fachmann

## Instrucciones para el final de vida y la eliminación de los componentes:

### Instructions on end-of-life and component disposal:

### Instructions pour la gestion des composants en fin de vie et leur mise au rebut :

### Istruzioni per il fine vita e lo smaltimento dei componenti:

### Anweisungen zur entsorgung der Leuchtenkomponenten:



Interrumpir la alimentación del aparato  
 Cut the power supply to the luminaire  
 Couper l'alimentation du luminaire  
 Interrompere l'alimentazione dell'apparecchio  
 Stromversorgung der Leuchte unterbrechen



Quitar la(s) fuente(s) de luz para el desecho  
 Remove light source(s) for disposal  
 Retirer la (les) source(s) lumineuse(s) pour l'élimination  
 Rimuovere la/le sorgente/e di luce per lo smaltimento  
 Lichtquelle(n) zur Entsorgung entfernen



Quitar la batería para el desecho  
 Remove the battery for decommissioning  
 Retirer la batterie pour sa mise au rebut  
 Rimuovere la batteria per la dismissione  
 Die Batterie ordnungsgemäß entsorgen



Quitar el equipo de control para el desecho  
 Remove control gear for disposal  
 Retirer le dispositif de commande pour l'élimination  
 Rimuovere l'alimentatore per lo smaltimento  
 Betriebsgerät zur Entsorgung ausbauen



Enviar los materiales a un centro de recogida RAEE  
 Send the materials to a WEEE collection centre  
 Envoyer les matériaux dans une déchetterie DEEE  
 Inviare i materiali ad un centro di raccolta RAEE  
 Die Materialien in einem WEEE-Zentrum entsorgen

