



Dimensiones



Accesorios



HONEYCOMB LOUVER



MINIMAL TRACK OPTIONS

Premios



reddot winner 2020
innovative product
& lighting design



Bronze Delta
ADI Awards 2020



HONORABLE MENTION
EUROPEAN
PRODUCT
DESIGN
AWARD



WINNER
2020



archiproducts
DESIGN AWARDS
WINNER 2020



ORO

PRODUCTO

Nombre	FIT 27 24V 2 MEDIUM 3500K G
Referencia	A3991023G
Color	Dorado
RAL	Pintura de nanopartículas metálicas
Categoría	TRACK LIGHTS

FUENTE DE LUZ

Tipo	LED
Flujo luminoso	560 lm
Temperatura de color	3500 K
Estabilidad cromática	MacAdam Step 2
Índice de reproducción cromática	CRI > 90
Potencia	5,5 W
Corriente	500 mA
Eficacia	102 lm/W
Horas de vida del LED	L90B10 > 108.000h
Eficiencia energética	F

LUMINARIA | DATOS FOTOMÉTRICOS

Eficiencia lumínica	82%
Ángulo del haz de luz	31°

LUMINARIA | DATOS ELÉCTRICOS

Potencia del sistema	6,34 W
Tensión	24Vdc
Regulación	Opciones DIM
Clase de seguridad eléctrica	⚡

OTROS DATOS

Estanqueidad	IP20
Control inalámbrico	Consultar
Ángulo de basculación	90°
Ángulo de giro	355°
Tipo de carril	Minimal Track
Peso	75 g
Peso con embalaje	115 g
Dimensiones embalaje	113 x 111 x 32 mm
Unidades por embalaje	1
Materiales	Aluminio / Policarbonato



Fit 27 24V es un proyector para el sistema Minimal Track. De geometría cilíndrica y formas esenciales, destaca por su minimalismo estético y su funcionalidad, ya que puede orientarse en todas las direcciones. El perímetro de su boca en negro acentúa su vocación antideslumbramiento.

Diagrama polar



Diagrama cónico



Guía de instalación

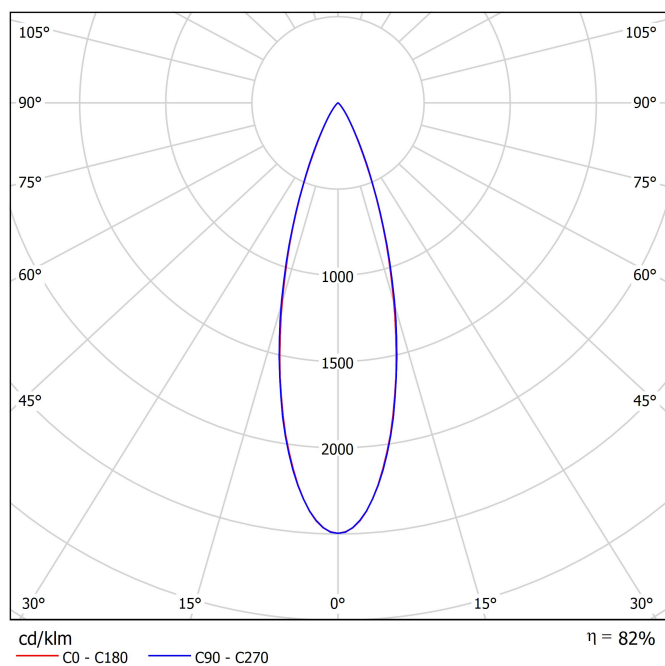
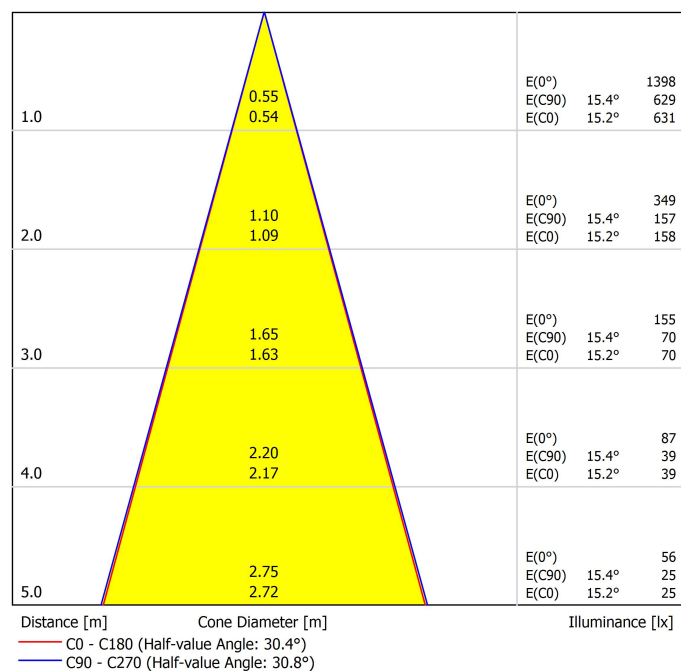

<https://youtu.be/KnedJbKp7oo>



	PRODUCT
Model	Anti-glare Honeycomb Louver
Reference	A3990000
Category	Accessories

NO SE VENDE POR SEPARADO 

Rejilla tipo panal antideslumbrante

Accesorio compuesto por una rejilla en forma de panal que controla el haz de luz, reduce el deslumbramiento y protege la visión directa de la fuente luminosa.

Minimal Track

ARKOSLIGHT

Minimal Track is a 24V low-voltage lighting system designed to create minimalist and highly configurable installations. On this page, you'll find the necessary components to configure your surface-mounted system.



Or use our online configurator to design your own custom product layout. The tool will guide you through the process and automatically calculate the required drivers and accessories. [Start your configuration →](#)



Track & accessories - Surface mounting

Configure the shape of your track, add end caps and the required accessories, and finish the setup with the conductive strip (rubber cable).

MINIMAL TRACK 24V

Profile 2m

A384-02-00- | N | WT |



Corner 90° 1 Plane

A384-00-02- | N | WT |

Cable length = 35mm.



End Cap

A384-00-05- | N | WT |



Rubber Cable n x 1m

A384-00-01- | N |

n = Total length of System



Corner 90° 1 Plane Rounded

A384-00-03- | N | WT |

Cable length = 35mm.



Connection Box

A384-00-06- | N | WT |



24V | Max. 4A |

Corner 90° 2 Planes

A384-00-04- | N | WT |

Cable length = 100mm.

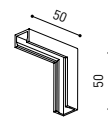

Power Supply

Select your power supply, include a dimmer if needed, and explore the installation diagrams provided.

		P	V	D (A x B x C)
MINIMAL TRACK 24V Power Supply Box	A384-00-07- NT WT	40W	24V	280 x 30 x 24mm
	A384-00-08- NT WT	100W	24V	280 x 30 x 24mm
MINIMAL TRACK 24V Remote Power Supply	0434-01-37	60W	24V	180 x 52 x 30mm
	0433-10-22	100W	24V	295 x 43 x 30mm
220 V ~ 240 V ~				
MINIMAL TRACK 24V Remote Constant Voltage Dimmer	0433-01-32	DALI / Push	24V	181 x 42 x 20mm
	0433-01-35	CASAMBI	24V	72,6 x 30 x 18mm
24V other DIM options please consult				



Connection diagram:



DROP VOLTAGE TABLE

POWER (W)	CABLE SECTION (mm ²)	CABLE LENGTH (m)			
		<5	<10	<20	<30
40	0,75	30	30	30	30
	1,5	30	30	30	30
60	0,75	30	30	20	10
	1,5	30	30	30	20
100	0,75	20	10	X	X
	1,5	20	20	10	X

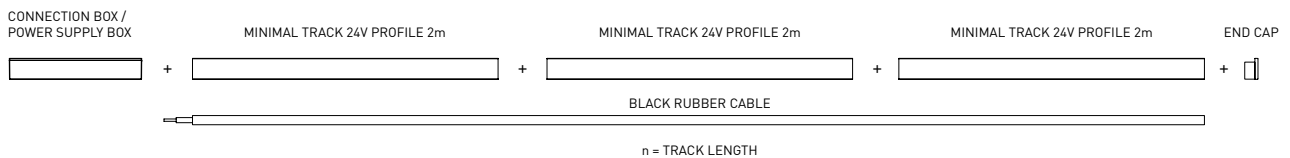

COLOUR | NT ■ RAL 9005 | WT □ RAL 9016 | N ■ RAL 9005 |

INSTALLATION GUIDE
<https://youtu.be/KnedJbKp7oo>



Minimal Track

ARKOSLIGHT

Minimal Track is a 24V low-voltage lighting system designed to create minimalist and highly configurable installations. On this page, you'll find the necessary components to configure your trimless-mounted system.



Or use our online configurator to design your own custom product layout. The tool will guide you through the process and automatically calculate the required drivers and accessories. [Start your configuration →](#)

Track & accessories - Trimless mounting

Configure the shape of your track, add end caps and the required accessories, and finish the setup with the conductive strip (rubber cable).

MINIMAL TRACK 24V

Trimless Profile 2m

A467-02-00- | N |

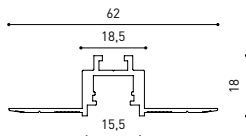

Trimless Rubber Cable n x 1m

A467-00-01- | N |



n = Total length of System

24 V | Max. 4A |

Trimless Corner 90° 1 Plane

A467-00-02- | N |

Cable length = 140mm.



Trim. Corner 90° 1 Plane Connc.

A467-00-03- | N |



Trimless End Caps

A467-00-05- | N |

Two End Caps Included



Trimless Straight Joiner

A467-00-06

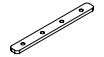

Trimless Connection Box

A467-00-07- | N |

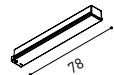

Power Supply

Select your power supply, include a dimmer if needed, and explore the installation diagrams provided.

		P	V	D (A x B x C)
MINIMAL TRACK 24V Remote Power Supply	0434-01-37	60W	24V	180 x 52 x 30mm
	0433-10-22	100W	24V	295 x 43 x 30mm

220 V ~
240

			V	D (A x B x C)
MINIMAL TRACK 24V Remote Constant Voltage Dimmer	0433-01-32	DALI / Push	24V	181 x 42 x 20mm
	0433-01-35	CASAMBI	24V	72,6 x 30 x 18mm

24V | other DIM options please consult



Connection diagram:



DROP VOLTAGE TABLE

POWER (W)	CABLE SECTION (mm ²)	CABLE LENGTH (m)			
		<5	<10	<20	<30
40	0,75	30	30	30	30
	1,5	30	30	30	30
60	0,75	30	30	20	10
	1,5	30	30	30	20
100	0,75	20	10	X	X
	1,5	20	20	10	X

Reduce 5 meters per each 'Corner 90° 1 Plane CONNECTOR' used.



COLOUR | NT ■ RAL 9005 | WT □ RAL 9016 | N ■ RAL 9005 |

INSTALLATION GUIDE
<https://youtu.be/KnedJbKp7oo>



Minimal Track

ARKOSLIGHT

Minimal Track is a 24V low-voltage lighting system designed to create minimalist and highly configurable installations. On this page, you'll find the necessary components to configure your suspension-mounted system.



Or use our online configurator to design your own custom product layout. The tool will guide you through the process and automatically calculate the required drivers and accessories. [Start your configuration →](#)



Track & accessories - Suspension mounting

Configure the shape of your track, add end caps and the required accessories, and finish the setup with the conductive strip (rubber cable).

MINIMAL TRACK 24V Suspension

Profile 2m

A384-02-00- | N | WT |



Rubber Cable n x 1m

A384-00-01- | N |

n = Total length of System

24V | Max. 4A | III



Suspension Straight Joiner

A400-00-02- | N | WT |



Profile 2m Initial feed kit

A400-02-10- | N | WT |



Suspension Kit

A400-02-04- | N | WT |

Max distance between suspension kits = 100 cm.

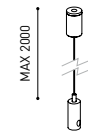

Profile 2m Middle feed kit*

A400-02-20- | N | WT |



Corner 90°

A400-00-03- | N | WT |



Suspension End Caps

A400-00-05- | N | WT |

Two End Caps Included.



* Unidirectional Middle Feed.

Cable length = 85mm.

Power Supply

Select your power supply, include a dimmer if needed, and explore the installation diagrams provided.

		P	V	D (A x B x C)	
MINIMAL TRACK 24V Susp Power Supply Box	NO DIM	A400-00-06- NT WT	40W	24V	280 x 30 x 36mm
		A400-00-07- NT WT	100W	24V	280 x 30 x 36mm
MINIMAL TRACK 24V Remote Power Supply	NO DIM	0434-01-37	60W	24V	180 x 52 x 30mm
		0433-10-22	100W	24V	295 x 43 x 30mm

220 V~
240

MINIMAL TRACK 24V Remote Constant Voltage Dimmer				
	0433-01-32	DALI / Push	24V	181 x 42 x 20mm
	0433-01-35	CASAMBI	24V	72,6 x 30 x 18mm

24V | other DIM options please consult

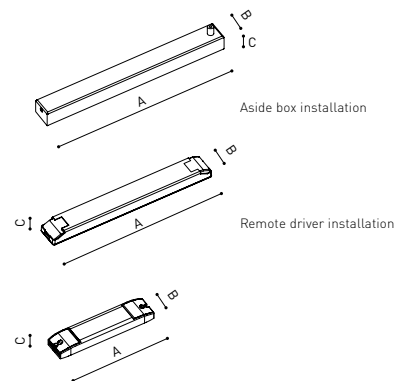

Connection diagram:

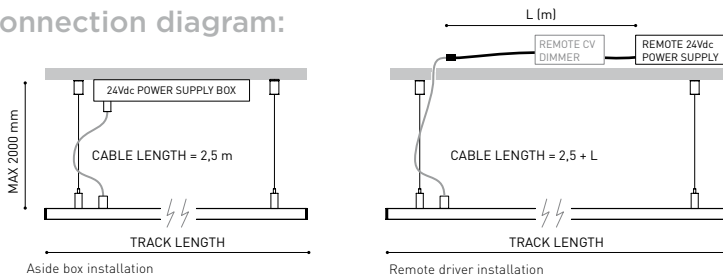

DROP VOLTAGE TABLE

POWER (W)	CABLE SECTION (mm ²)	CABLE LENGTH (m)			
		<5	<10	<20	<30
40	0,75	30	30	30	30
	1,5	30	30	30	30
60	0,75	30	30	20	10
	1,5	30	30	30	20
100	0,75	20	10	X	X
	1,5	20	20	10	X

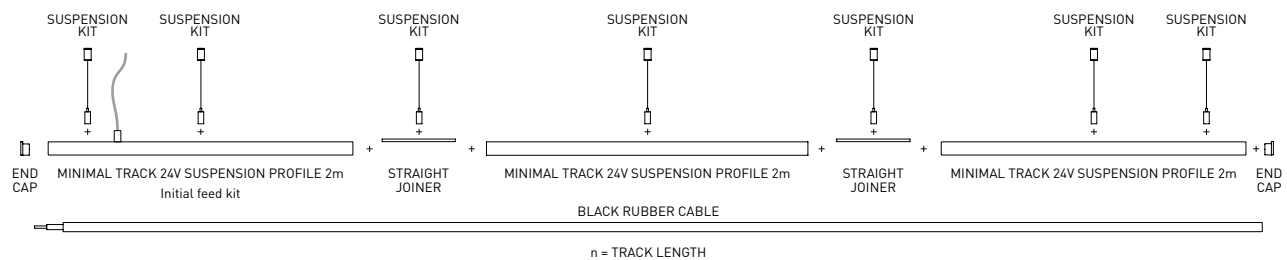

COLOUR | NT ■ RAL 9005 | WT □ RAL 9016 | N ■ RAL 9005 |



Model	Coaxial Trimless
Reference	A023-00-03- W N
Colour	W <input type="checkbox"/> RAL 9016 N <input checked="" type="checkbox"/> RAL 9005
Category	Accessories



Dimmensional drawing

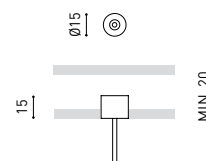

Accesorio para cable trimless

Wire Trimless Accessory es una colección de accesorios que permiten instalar los tensores y cables de las luminarias de suspensión de Arkoslight directamente desde el techo, sin ningún florón ni anclaje visto. Se logra así una aplicación minimalista y visualmente limpia en el espacio.

Con los Wire Trimless Accessory los elementos adyacentes al techo del producto estándar (florones, anclajes, cajas de driver...) se esconden a través de una simple aplicación de empotramiento.

Wire Trimless Accessory reduce el peso visual de la instalación y genera una estética extremadamente minimalista. Los cables nacen desde el material en el techo como parte de la estructura. Este detalle genera una disposición mucho más pura y esencial, especialmente, en composiciones de varias unidades.



INSTALLATION GUIDE

https://youtu.be/sa_xAgj4ji4



PRODUCT

Model	Trimless Tool D20 X D52 MM
Reference	A478-00-01
Category	Accessories





Fuente de luz (LED) reemplazable por un profesional autorizado
 Replaceable (LED only) light source by an authorized professional.
 Source lumineuse (LED) remplaçable par un professionnel agréé
 Sorgente luminosa (LED) sostituibile da parte di un professionista autorizzato
 Austauschbare (LED) Lichtquelle durch einen autorisierten Fachmann



Equipo de control reemplazable por un profesional autorizado
 Replaceable control gear by an authorized professional
 Dispositif de commande remplaçable par un professionnel agréé
 Alimentatore sostituibile da parte di un professionista autorizzato
 Auswechselbares Betriebsgerät durch autorisierten Fachmann

Instrucciones para el final de vida y la eliminación de los componentes:

Instructions on end-of-life and component disposal:

Instructions pour la gestion des composants en fin de vie et leur mise au rebut :

Istruzioni per il fine vita e lo smaltimento dei componenti:

Anweisungen zur entsorgung der Leuchtenkomponenten:



Interrumpir la alimentación del aparato
 Cut the power supply to the luminaire
 Couper l'alimentation du luminaire
 Interrompere l'alimentazione dell'apparecchio
 Stromversorgung der Leuchte unterbrechen



Quitar la(s) fuente(s) de luz para el desecho
 Remove light source(s) for disposal
 Retirer la (les) source(s) lumineuse(s) pour l'élimination
 Rimuovere la/le sorgente/e di luce per lo smaltimento
 Lichtquelle(n) zur Entsorgung entfernen



Quitar la batería para el desecho
 Remove the battery for decommissioning
 Retirer la batterie pour sa mise au rebut
 Rimuovere la batteria per la dismissione
 Die Batterie ordnungsgemäß entsorgen



Quitar el equipo de control para el desecho
 Remove control gear for disposal
 Retirer le dispositif de commande pour l'élimination
 Rimuovere l'alimentatore per lo smaltimento
 Betriebsgerät zur Entsorgung ausbauen



Enviar los materiales a un centro de recogida RAEE
 Send the materials to a WEEE collection centre
 Envoyer les matériaux dans une déchetterie DEEE
 Inviare i materiali ad un centro di raccolta RAEE
 Die Materialien in einem WEEE-Zentrum entsorgen

