

DIMENSIONES

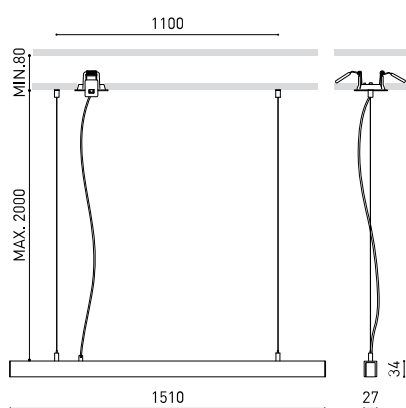

ACCESORIOS



WIRE TRIMLESS ACCESSORY



TRIMLESS TOOL

Nombre	LINE SUSP 1500 DIM PUSH 4000K NT
Referencia	A4361032NT
Color	Textured black
RAL	9005
Categoría	SUSPENSION

FUENTE DE LUZ

Tipo	LED
Flujo Luminoso	4950 lm
Temperatura de color	4000 K
Estabilidad cromática	MacAdam Step 2
Índice de reproducción cromática	CRI > 90
Potencia	31,5 W
Corriente	1050 mA
Eficacia	157 lm/W
Horas de Vida del LED	L80B10 > 60.000h

LUMINARIA | DATOS FOTOMÉTRICOS

Eficiencia Lumínica	40%
Ángulo del haz de luz	100°

LUMINARIA | DATOS ELÉCTRICOS

Driver	Included
Potencia del sistema	36,21 W
Tensión	220V/240V
Frecuencia	50/60 Hz
Regulación	Push
Clase de seguridad eléctrica	<input type="checkbox"/>

OTROS DATOS

Estanqueidad	IP20
Control inalámbrico	Please Consult
Medidas de empotramiento	Ø62 mm
Longitud del cable	Max. 2 m
Tensor de regulación rápida	Yes
Peso	1395 g
Peso con embalaje	2380 g
Dimensiones embalaje	Ø105 x 1820 mm
Unidades por embalaje	1
Materiales	Aluminium / Polycarbonate

Line Suspension is an elegant luminaire composed of a linear light which can combine direct and indirect light... Its pure volumes - a diffuser inserted in the aluminium core - and its miniaturised components make its integration into the architectural space extraordinary. The range consists of 3 versions: Line Suspension, Line Suspension Direct&Indirect and a Micro version. All these products are available in two lengths.

DIAGRAMA POLAR



DIAGRAMA CÓNICO



WIRE TRIMLESS ACCESSORY

ARKOSLIGHT®

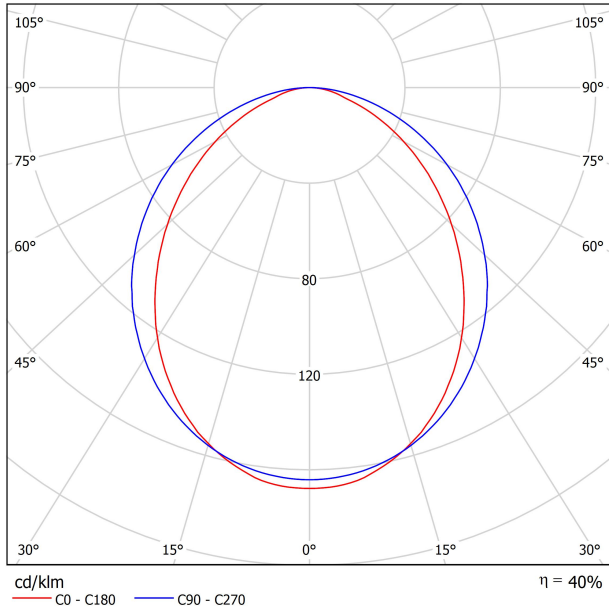
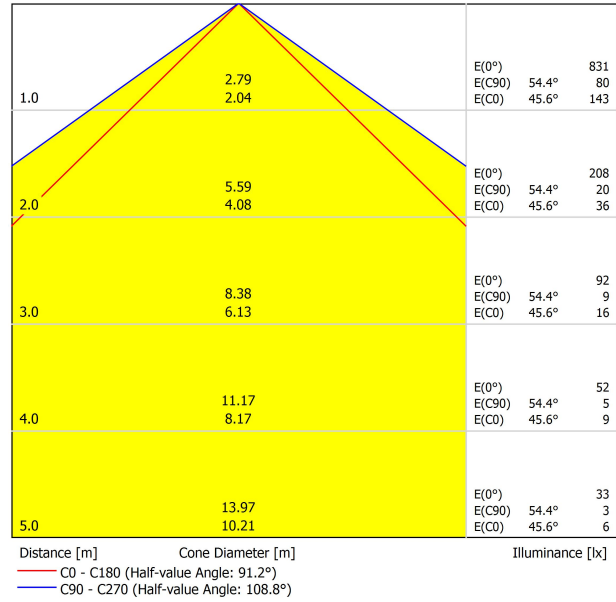
LINE SUSPENSION & LINE MICRO SUSPENSION

FEED



PRODUCT	
Model	Coaxial Trimless
Reference	A023-00-03- W N
Colour	W <input type="checkbox"/> RAL 9016 N <input type="checkbox"/> RAL 9005
Category	Accessories

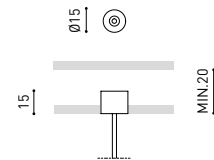

FASTENING



PRODUCT	
Model	Steel Cable Trimless
Reference	A023-00-05- W N
Colour	W <input type="checkbox"/> RAL 9016 N <input type="checkbox"/> RAL 9005
Category	Accessories

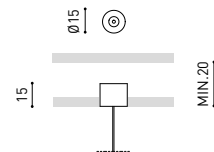

Wire Trimless Accessory is a collection of accessories for fitting tensioners and cables to Arkoslight luminaires suspended directly from the ceiling with any visible ceiling rose or fixings. This achieves a minimalist application with a visually tidy finish.

With Wire Trimless Accessory the items adjacent to the ceiling of the standard product (ceiling roses, fixings, driver boxes, etc.) are concealed by a simple recessed application.

Wire Trimless Accessory reduces the visual impact of the installation leading to extremely minimalist aesthetics. The wires come out of the ceiling material as a part of the structure. This detail creates a much purer, more essential layout, particular when several luminaires are fitted in an arrangement.





INSTALLATION GUIDE

https://youtu.be/sa_xAgj4ji4

PRODUCT

Model	Trimless Tool D20 X D52 MM
Reference	A478-00-01
Category	Accessories





Fuente de luz (LED) reemplazable por un profesional autorizado
 Replaceable (LED only) light source by an authorized professional.
 Source lumineuse (LED) remplaçable par un professionnel agréé
 Sorgente luminosa (LED) sostituibile da parte di un professionista autorizzato
 Austauschbare (LED) Lichtquelle durch einen autorisierten Fachmann



Equipo de control reemplazable por un profesional autorizado
 Replaceable control gear by an authorized professional
 Dispositif de commande remplaçable par un professionnel agréé
 Alimentatore sostituibile da parte di un professionista autorizzato
 Auswechselbares Betriebsgerät durch autorisierten Fachmann

INSTRUCCIONES PARA EL FINAL DE VIDA Y LA ELIMINACIÓN LOS COMPONENTES
 INSTRUCTIONS ON END-OF-LIFE AND COMPONENT DISPOSAL
 INSTRUCTIONS POUR LA GESTION DES COMPOSANTS EN FIN DE VIE ET LEUR MISE AU REBUT
 ISTRUZIONI PER IL FINE VITA E LO SMALTIMENTO DEI COMPONENTI
 ANWEISUNGEN ZUR ENTSORGUNG DER LEUCHTENKOMPONENTEN



Interrumpir la alimentación del aparato
 Cut the power supply to the luminaire
 Couper l'alimentation du luminaire
 Interrompere l'alimentazione dell'apparecchio
 Stromversorgung der Leuchte unterbrechen



Quitar la(s) fuente(s) de luz para el desecho
 Remove light source(s) for disposal
 Retirer la (les) source(s) lumineuse(s) pour l'élimination
 Rimuovere la/le sorgente/e di luce per lo smaltimento
 Lichtquelle(n) zur Entsorgung entfernen



Quitar la batería para el desecho
 Remove the battery for decommissioning
 Retirer la batterie pour sa mise au rebut
 Rimuovere la batteria per la dismissione
 Die Batterie ordnungsgemäß entsorgen



Quitar el equipo de control para el desecho
 Remove control gear for disposal
 Retirer le dispositif de commande pour l'élimination
 Rimuovere l'alimentatore per lo smaltimento
 Betriebsgerät zur Entsorgung ausbauen

Enviar los materiales a un centro de recogida RAEE
 Send the materials to a WEEE collection centre
 Envoyer les matériaux dans une déchetterie DEEE
 Inviare i materiali ad un centro di raccolta RAEE
 Die Materialien in einem WEEE-Zentrum entsorgen

