

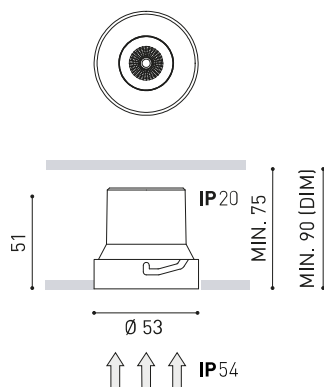

DIMENSIONS



ACCESSORIES



TRIMLESS ACCESSORY
(MANDATORY)



TRIMLESS TOOL

Name	SHOT LIGHT S TRIMLESS IP54 FLOOD DIM PH.CUT 2700K NMG
Reference	A4631510NMG
Color	Black-Metallized gold
RAL	Metallic finish
Category	CEILING RECESSED

PRODUCT

Name	SHOT LIGHT S TRIMLESS IP54 FLOOD DIM PH.CUT 2700K NMG
Reference	A4631510NMG
Color	Black-Metallized gold
RAL	Metallic finish
Category	CEILING RECESSED

LIGHT SOURCE

Type	LED
Gross luminous flux	580 lm
Colour temperature	2700 K
Chromatic stability	MacAdam Step 2
Colour Rendering Index	CRI > 90
Power	6 W
Current	500 mA
Efficacy	97 lm/W
LED lifespan	L80B10 > 60.000h

LIGHTING FIXTURE | PHOTOMETRIC DATA

Lighting efficiency	78%
Light beam angle	34°

LIGHTING FIXTURE | ELECTRICAL DATA

Driver	Included - Connected
Power values of the system	8,28 W
Frequency	50/60 Hz
Dimming	Phase Cut - Other DIM, please consult
Electrical insulation class	□

OTHER DATA

Sealing	IP54
Wireless control	Please Consult
Emergency power supply	Please Consult
Recess measurements	Ø59 mm
Weight	145 g
Packaged weight	215 g
Packaging dimensions	173 x 85 x 74 mm
Units per package	1
Materials	Aluminium / Acrylonitrile Butadiene Styrene / Polycarbonate



A luminary conceived to be a discreet point of light in the ceiling that hides the illumination source from sight and aims to offer maximum visual comfort. In order to achieve this, it has an anti-glare screen and a specifically designed micro-reflector that generates a perfectly defined light beam.

POLAR DIAGRAM

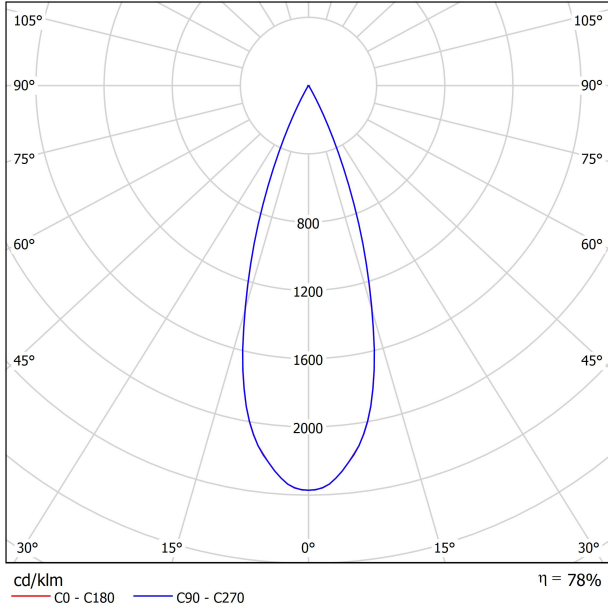

CONICAL DIAGRAM

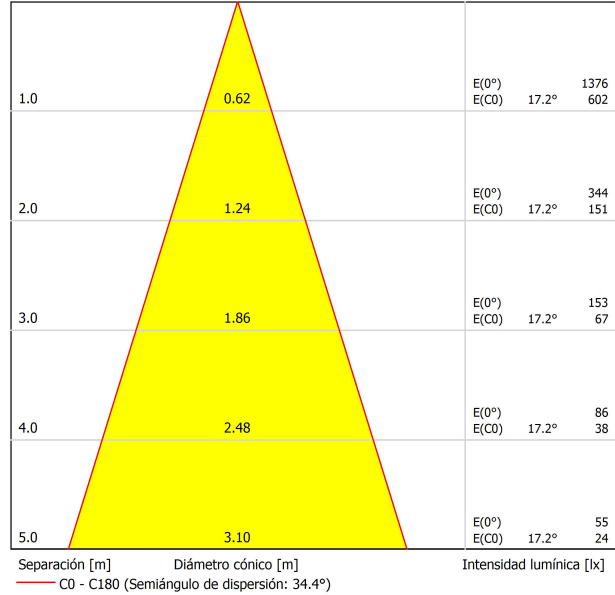

UGR

Valoración de deslumbramiento según UGR												
ρ Techo		70	70	50	50	30	70	70	50	50	30	30
ρ Paredes		50	30	50	30	30	50	30	50	30	30	30
ρ Suelo		20	20	20	20	20	20	20	20	20	20	20
Tamaño del local X Y		Mirado en perpendicular al eje de lámpara					Mirado longitudinalmente al eje de lámpara					
2H	2H	-2.6	-2.0	-2.3	-1.8	-1.6	-2.3	-1.7	-2.1	-1.5	-1.3	
	3H	-2.1	-1.5	-1.8	-1.3	-1.1	-1.9	-1.3	-1.6	-1.1	-0.9	
	4H	-1.6	-1.0	-1.3	-0.8	-0.5	-1.4	-0.8	-1.1	-0.6	-0.3	
	6H	-0.7	-0.2	-0.4	0.1	0.4	-0.6	-0.1	-0.3	0.2	0.4	
	8H	0.1	0.6	0.5	0.9	1.2	0.1	0.6	0.4	0.9	1.2	
4H	12H	1.0	1.4	1.3	1.7	2.0	1.0	1.5	1.4	1.8	2.1	
	2H	-2.6	-2.1	-2.3	-1.8	-1.5	-2.3	-1.8	-2.0	-1.6	-1.3	
	3H	-1.8	-1.4	-1.5	-1.1	-0.8	-1.6	-1.2	-1.3	-0.9	-0.6	
	4H	-1.0	-0.6	-0.7	-0.3	0.0	-0.9	-0.5	-0.5	-0.2	0.2	
	6H	0.2	0.5	0.6	0.9	1.3	0.2	0.6	0.6	0.9	1.3	
8H	8H	1.3	1.6	1.7	1.9	2.3	1.2	1.5	1.6	1.9	2.2	
	12H	2.4	2.6	2.8	3.0	3.4	2.4	2.6	2.8	3.0	3.4	
	4H	-0.7	-0.4	-0.2	0.0	0.4	-0.5	-0.2	-0.1	0.1	0.5	
	6H	0.9	1.1	1.4	1.6	2.0	0.9	1.1	1.4	1.6	2.0	
	8H	2.2	2.4	2.7	2.8	3.3	2.1	2.3	2.6	2.7	3.2	
12H	12H	3.6	3.7	4.1	4.2	4.7	3.6	3.8	4.1	4.2	4.7	
	4H	-0.5	-0.3	-0.1	0.1	0.5	-0.4	-0.2	0.0	0.2	0.7	
	6H	1.2	1.3	1.6	1.8	2.2	1.2	1.3	1.6	1.8	2.3	
8H	2.6	2.7	3.1	3.2	3.7	2.5	2.6	3.0	3.1	3.6		
Variación de la posición del espectador para separaciones S entre luminarias												
S = 1.0H		+1.6 / -0.5					+1.8 / -0.6					
S = 1.5H		+3.3 / -0.9					+3.6 / -0.9					
S = 2.0H		+4.9 / -1.0					+5.3 / -1.2					
Tabla estándar Sumando de corrección		---					---					
Índice de deslumbramiento corregido en relación a 580lm Flujo luminoso total												



DRIVER

0000-94-44	DRIVER PHASE CUT 7W 500mA
------------	---------------------------

PHASE CUT DIMMERS TESTED FOR COMPATIBILITY:

Brand / Manufacturer	Model number	Dimming Type
Busch-Jaeger	6523 U-102	Trailing edge
Busch-Jaeger	6523 UR-103	Trailing edge
Niko	310-0190X	Trailing edge
Jung	LB-Management	Trailing edge
HZC Electric	AU-P3	Trailing edge
Philips	SED-200A	Trailing edge
Merten/Schneider	SBD315RC	Trailing edge
Etman	ETM327	Trailing edge
Etman	ETM329	Trailing edge
Etman (EGANT)	U321V2	Trailing edge
Casambi	CBU-TED	Trailing edge

THE PARTICULAR CONDITIONS OF EACH INSTALLATION AND THE SPECIFICATIONS AND CONDITIONS OF USE OF EACH REGULATOR, MAY DIFFER FROM THOSE CONSIDERED IN THE COMPATIBILITY TESTING, AND AFFECT ITS PERFORMANCE IN SAID INSTALLATION.

MANDATORY FOR INSTALLATION

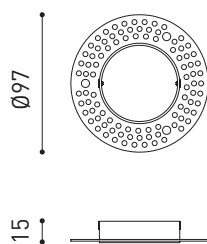

PRODUCT	
Model	Shot Light S Trimless accessory
Reference	A4630000
Material	Iron
Coating	Zinc plated
Category	Accessories





INSTALLATION GUIDE

https://youtu.be/sa_xAgj4ji4

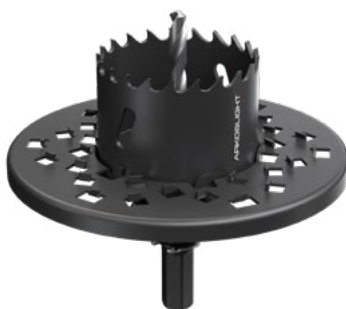

PRODUCT

Model	Trimless Tool D59 X D100 MM
Reference	A478-00-03
Category	Accessories

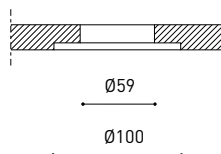
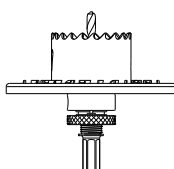



Fuente de luz (LED) reemplazable por un profesional autorizado

Replaceable (LED only) light source by an authorized professional.

Source lumineuse (LED) remplaçable par un professionnel agréé

Sorgente luminosa (LED) sostituibile da parte di un professionista autorizzato

Austauschbare (LED) Lichtquelle durch einen autorisierten Fachmann



Equipo de control reemplazable por un profesional autorizado

Replaceable control gear by an authorized professional

Dispositif de commande remplaçable par un professionnel agréé

Alimentatore sostituibile da parte di un professionista autorizzato

Auswechselbares Betriebsgerät durch autorisierten Fachmann

INSTRUCCIONES PARA EL FINAL DE VIDA Y LA ELIMINACIÓN LOS COMPONENTES
 INSTRUCTIONS ON END-OF-LIFE AND COMPONENT DISPOSAL
 INSTRUCTIONS POUR LA GESTION DES COMPOSANTS EN FIN DE VIE ET LEUR MISE AU REBUT
 ISTRUZIONI PER IL FINE VITA E LO SMALTIMENTO DEI COMPONENTI
 ANWEISUNGEN ZUR ENTSORGUNG DER LEUCHTENKOMPONENTEN



Interrumpir la alimentación del aparato
 Cut the power supply to the luminaire
 Couper l'alimentation du luminaire
 Interrompere l'alimentazione dell'apparecchio
 Stromversorgung der Leuchte unterbrechen



Quitar la(s) fuente(s) de luz para el desecho
 Remove light source(s) for disposal
 Retirer la (les) source(s) lumineuse(s) pour l'élimination
 Rimuovere la/le sorgente/e di luce per lo smaltimento
 Lichtquelle(n) zur Entsorgung entfernen



Quitar la batería para el desecho
 Remove the battery for decommissioning
 Retirer la batterie pour sa mise au rebut
 Rimuovere la batteria per la dismissione
 Die Batterie ordnungsgemäß entsorgen



Quitar el equipo de control para el desecho
 Remove control gear for disposal
 Retirer le dispositif de commande pour l'élimination
 Rimuovere l'alimentatore per lo smaltimento
 Betriebsgerät zur Entsorgung ausbauen



Enviar los materiales a un centro de recogida RAEE
 Send the materials to a WEEE collection centre
 Envoyer les matériaux dans une déchetterie DEEE
 Inviare i materiali ad un centro di raccolta RAEE
 Die Materialien in einem WEEE-Zentrum entsorgen

