

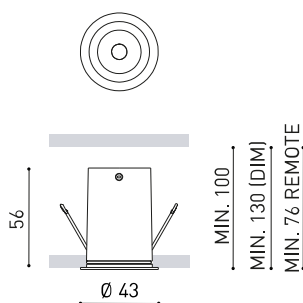

DIMENSIONES



Nombre	LENS LIGHT DIM DALI 4000K W
Referencia	A4690202W
Color	Blanco
RAL	Color en masa similar a RAL 9016
Categoría	CEILING RECESSED
Tipo	LED
Flujo Luminoso	580 lm
Temperatura de color	4000 K
Estabilidad cromática	MacAdam Step 2
Índice de reproducción cromática	CRI > 90
Potencia	5,7 W
Corriente	500 mA
Eficacia	102 lm/W
Horas de Vida del LED	L90B10 > 108.000h
Eficiencia Lumínica	82%
Ángulo del haz de luz	12°
Driver	Incluido
Potencia del sistema	7,76 W
Tensión	220V/240V
Frecuencia	50/60 Hz
Regulación	DALI - Otros DIM, consultar
Clase de seguridad eléctrica	<input type="checkbox"/>
Estanqueidad	IP20
Control inalámbrico	Consultar
Medidas de empotramiento	Ø38 mm
Peso	155 g
Peso con embalaje	205 g
Dimensiones embalaje	198 x 82 x 70 mm
Unidades por embalaje	1
Materiales	Aluminio / Acrilonitrilo Butadieno Estireno / Policarbonato

PRODUCTO

FUENTE DE LUZ

LUMINARIA | DATOS FOTOMÉTRICOS

LUMINARIA | DATOS ELÉCTRICOS

OTROS DATOS



La luminaria compacta Lens Light baña la figura con una luz escénica, potente y concentrada, perfecta como iluminación de acento. Su diseño sigue la línea discreta y de aparente sencillez del Shot Light, más gana presencia decorativa como punto de luz dirigida que explora la vertiente más dramática de la iluminación de interior.

DIAGRAMA POLAR



DIAGRAMA CÓNICO



UGR

Glare Evaluation According to UGR											
ρ Ceiling		70	70	50	50	30	70	70	50	50	30
ρ Walls		50	30	50	30	30	50	30	50	30	30
ρ Floor		20	20	20	20	20	20	20	20	20	20
Room Size X Y		Viewing direction at right angles to lamp axis					Viewing direction parallel to lamp axis				
2H	2H	3.6	4.3	3.9	4.5	4.7	3.7	4.3	3.9	4.5	4.7
	3H	3.9	4.5	4.2	4.8	5.0	3.9	4.5	4.2	4.8	5.0
	4H	4.0	4.6	4.3	4.8	5.1	4.0	4.6	4.3	4.8	5.1
	6H	4.2	4.7	4.5	4.9	5.2	4.2	4.7	4.5	5.0	5.3
	8H	4.3	4.8	4.6	5.1	5.4	4.4	4.9	4.7	5.2	5.5
4H	12H	4.5	5.0	4.9	5.3	5.6	4.7	5.2	5.0	5.5	5.8
	2H	3.8	4.4	4.1	4.6	4.9	3.8	4.4	4.1	4.7	4.9
	3H	4.1	4.6	4.5	4.9	5.2	4.1	4.6	4.5	4.9	5.2
	4H	4.3	4.7	4.6	5.0	5.3	4.3	4.7	4.6	5.0	5.3
	6H	4.5	4.9	4.9	5.2	5.6	4.6	4.9	5.0	5.3	5.7
8H	8H	4.8	5.1	5.2	5.5	5.9	4.9	5.2	5.3	5.6	6.0
	12H	5.1	5.4	5.6	5.8	6.2	5.4	5.6	5.8	6.0	6.5
	4H	4.3	4.6	4.7	5.0	5.4	4.3	4.6	4.7	5.0	5.4
	6H	4.7	4.9	5.2	5.4	5.8	4.8	5.0	5.2	5.4	5.9
	8H	5.1	5.3	5.6	5.7	6.2	5.3	5.4	5.7	5.9	6.3
12H	12H	5.7	5.8	6.1	6.3	6.8	6.0	6.1	6.4	6.6	7.1
	4H	4.3	4.5	4.7	4.9	5.4	4.3	4.5	4.7	4.9	5.4
	6H	4.8	5.0	5.2	5.4	5.9	4.9	5.0	5.3	5.5	6.0
	8H	5.3	5.4	5.7	5.9	6.4	5.4	5.5	5.9	6.0	6.5
	Variation of the observer position for the luminaire distances S										
S = 1.0H		+3.6 / -7.7					+3.5 / -7.5				
S = 1.5H		+6.2 / -8.9					+6.2 / -8.6				
S = 2.0H		+8.2 / -10.3					+8.2 / -10.0				
Standard table		BK00					BK00				
Correction Summand		-3.0					-3.0				
Corrected Glare Indices referring to 580lm Total Luminous Flux											

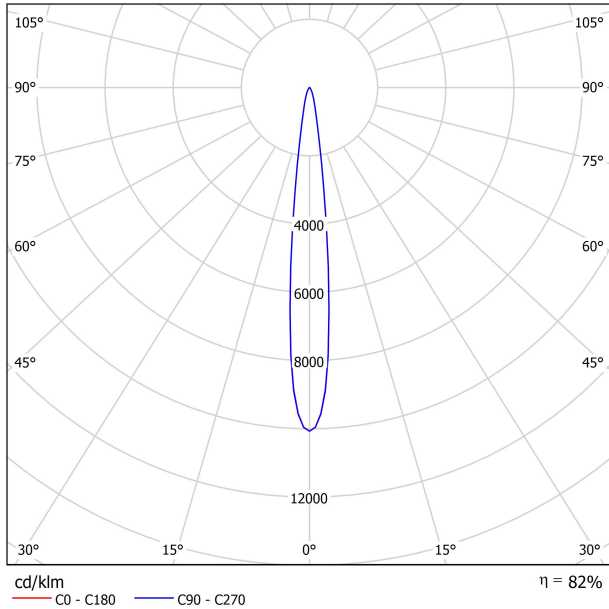
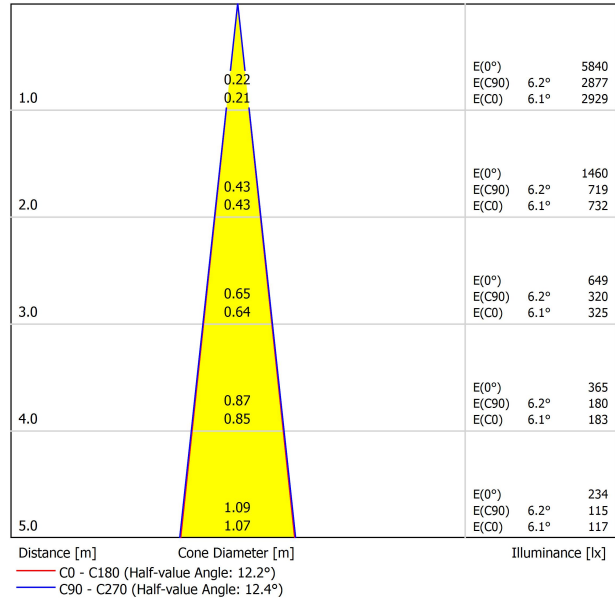

Fuente de luz (LED) reemplazable por un profesional autorizado
 Replaceable (LED only) light source by an authorized professional.
 Source lumineuse (LED) remplaçable par un professionnel agréé
 Sorgente luminosa (LED) sostituibile da parte di un professionista autorizzato
 Austauschbare (LED) Lichtquelle durch einen autorisierten Fachmann



Equipo de control reemplazable por un profesional autorizado
 Replaceable control gear by an authorized professional
 Dispositif de commande remplaçable par un professionnel agréé
 Alimentatore sostituibile da parte di un professionista autorizzato
 Auswechselbares Betriebsgerät durch autorisierten Fachmann

INSTRUCCIONES PARA EL FINAL DE VIDA Y LA ELIMINACIÓN LOS COMPONENTES
 INSTRUCTIONS ON END-OF-LIFE AND COMPONENT DISPOSAL
 INSTRUCTIONS POUR LA GESTION DES COMPOSANTS EN FIN DE VIE ET LEUR MISE AU REBUT
 ISTRUZIONI PER IL FINE VITA E LO SMALTIMENTO DEI COMPONENTI
 ANWEISUNGEN ZUR ENTSORGUNG DER LEUCHTENKOMPONENTEN



Interrumpir la alimentación del aparato
 Cut the power supply to the luminaire
 Couper l'alimentation du luminaire
 Interrompere l'alimentazione dell'apparecchio
 Stromversorgung der Leuchte unterbrechen



Quitar la(s) fuente(s) de luz para el desecho
 Remove light source(s) for disposal
 Retirer la (les) source(s) lumineuse(s) pour l'élimination
 Rimuovere la/le sorgente/e di luce per lo smaltimento
 Lichtquelle(n) zur Entsorgung entfernen



Quitar la batería para el desecho
 Remove the battery for decommissioning
 Retirer la batterie pour sa mise au rebut
 Rimuovere la batteria per la dismissione
 Die Batterie ordnungsgemäß entsorgen



Quitar el equipo de control para el desecho
 Remove control gear for disposal
 Retirer le dispositif de commande pour l'élimination
 Rimuovere l'alimentatore per lo smaltimento
 Betriebsgerät zur Entsorgung ausbauen

Enviar los materiales a un centro de recogida RAEE
 Send the materials to a WEEE collection centre
 Envoyer les matériaux dans une déchetterie DEEE
 Inviare i materiali ad un centro di raccolta RAEE
 Die Materialien in einem WEEE-Zentrum entsorgen

