

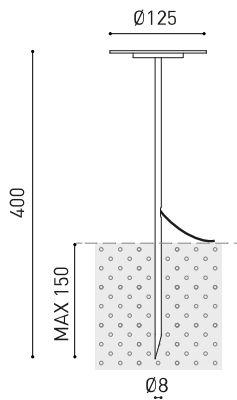

DIMENSIONS



ACCESSORIES



DRIVER OPTIONS



CONNECTOR IP67

Name	YORU SPIKE 24V 2700K 40CM WT
Reference	A4751000WT
Color	Textured white
RAL	9016
Category	OUTDOOR

PRODUCT

Type	LED
Gross luminous flux	400 lm
Colour temperature	2700 K
Chromatic stability	MacAdam Step 2
Colour Rendering Index	CRI > 90
Power	3 W
Efficacy	133 lm/W
LED lifespan	L80B10 > 60.000h

LIGHT SOURCE

Lighting efficiency	84%
Light beam angle	100°

LIGHTING FIXTURE | PHOTOMETRIC DATA

Driver	Excluded
Dimming	Please Consult
Electrical insulation class	⚡

LIGHTING FIXTURE | ELECTRICAL DATA

Sealing	IP65
Outdoor Use	Yes
Weight	250 g
Packaged weight	527 g
Packaging dimensions	552 x 147 x 147 mm
Units per package	1
Materials	Stainless Steel (AISI 304) / Aluminium / Polycarbonate

OTHER DATA



Yoru's presence is ethereal and sinuous, almost sculptural. Its warm and perfectly expressed light makes everything around it more genuine and deeper. Now its design goes outdoors with a waterproof version designed to bloom as ambient light points in the garden, composing water lily silhouettes at two different heights.



POLAR DIAGRAM

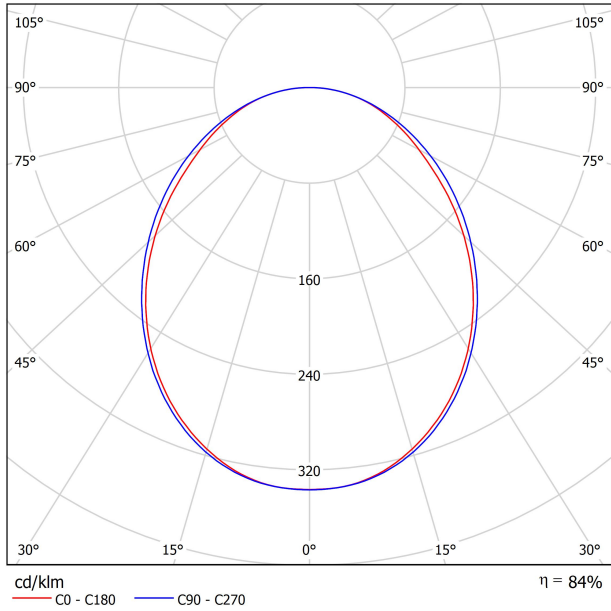

CONICAL DIAGRAM

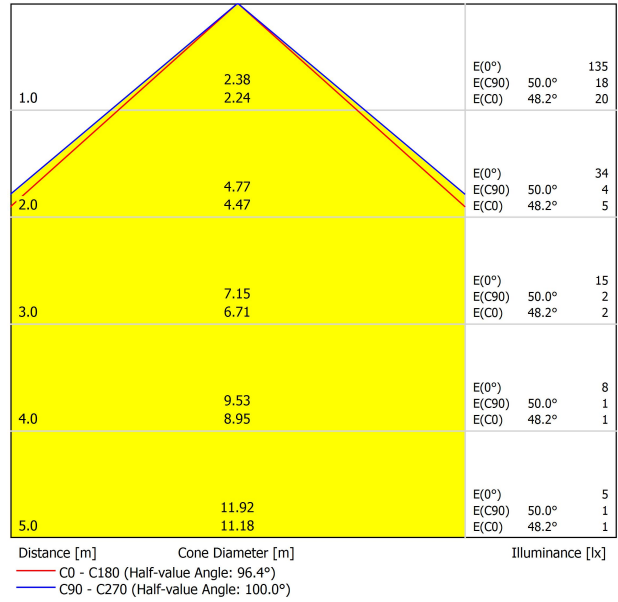

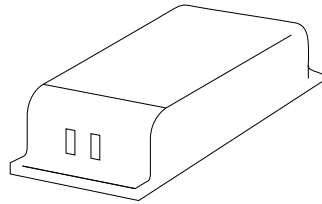

			P	V	D (A x B x C)
24V Power Supply	ON/OFF	0434-01-37	60W	24V	180 x 52 x 30mm
		0433-10-22	100W	24V	295 x 43 x 30mm

220 V~
240

MUST BE PLACED ON REMOTE

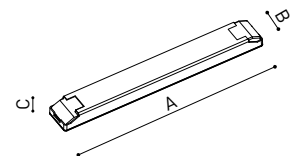

			P	V	D (A x B x C)
24V Dimmer		0433-01-32	DALI/PUSH	24V	181 x 42 x 20mm
		0433-01-35	CASAMBI	24V	72,6 x 30 x 18mm
		0434-01-64	WIFI	24V	105 x 44 x 23mm

24V

MUST BE PLACED ON REMOTE

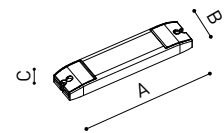

DROP VOLTAGE TABLE

POWER (W)	CABLE SECTION (mm ²)	CABLE LENGTH (m)			
		<25	<50	<75	<100
60	0,75	✓	✓	✗	✗
	1,5	✓	✓	✓	✓
100	0,75	✓	✗	✗	✗
	1,5	✓	✓	✓	✗

IP67 CONNECTOR

ARKOSLIGHT®

OPTIONAL ACCESSORY

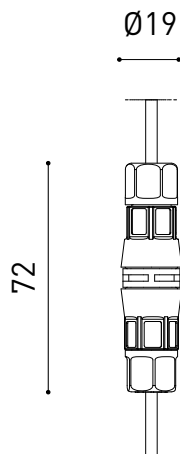

PRODUCT	
Model	Connector IP67
Reference	0434-01- 67 N
Category	Accessories

For cable $\text{Ø}3,5 - 7,5\text{mm}$ | section $\leq 1,5\text{mm}^2$

IP67 CONNECTOR

ARKOSLIGHT

OPTIONAL ACCESSORY

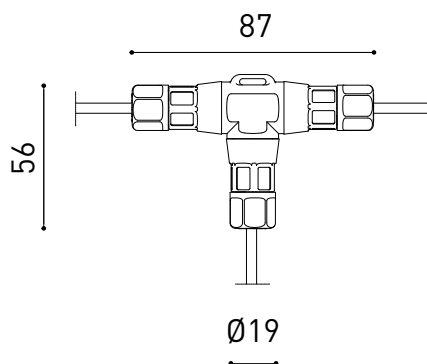

	PRODUCT
Model	Connector IP67 T-Shape
Reference	0434-01- 68 N
Category	Accessories

For cable Ø3,5 - 7,5mm | section ≤ 1,5mm²



Fuente de luz (LED) reemplazable por un profesional autorizado

Replaceable (LED only) light source by an authorized professional.

Source lumineuse (LED) remplaçable par un professionnel agréé

Sorgente luminosa (LED) sostituibile da parte di un professionista autorizzato

Austauschbare (LED) Lichtquelle durch einen autorisierten Fachmann



Equipo de control reemplazable por un profesional autorizado

Replaceable control gear by an authorized professional

Dispositif de commande remplaçable par un professionnel agréé

Alimentatore sostituibile da parte di un professionista autorizzato

Auswechselbares Betriebsgerät durch autorisierten Fachmann

INSTRUCCIONES PARA EL FINAL DE VIDA Y LA ELIMINACIÓN LOS COMPONENTES
 INSTRUCTIONS ON END-OF-LIFE AND COMPONENT DISPOSAL
 INSTRUCTIONS POUR LA GESTION DES COMPOSANTS EN FIN DE VIE ET LEUR MISE AU REBUT
 ISTRUZIONI PER IL FINE VITA E LO SMALTIMENTO DEI COMPONENTI
 ANWEISUNGEN ZUR ENTSORGUNG DER LEUCHTENKOMPONENTEN



Interrumpir la alimentación del aparato
 Cut the power supply to the luminaire
 Couper l'alimentation du luminaire
 Interrompere l'alimentazione dell'apparecchio
 Stromversorgung der Leuchte unterbrechen



Quitar la(s) fuente(s) de luz para el desecho
 Remove light source(s) for disposal
 Retirer la (les) source(s) lumineuse(s) pour l'élimination
 Rimuovere la/le sorgente/e di luce per lo smaltimento
 Lichtquelle(n) zur Entsorgung entfernen



Quitar la batería para el desecho
 Remove the battery for decommissioning
 Retirer la batterie pour sa mise au rebut
 Rimuovere la batteria per la dismissione
 Die Batterie ordnungsgemäß entsorgen



Quitar el equipo de control para el desecho
 Remove control gear for disposal
 Retirer le dispositif de commande pour l'élimination
 Rimuovere l'alimentatore per lo smaltimento
 Betriebsgerät zur Entsorgung ausbauen



Enviar los materiales a un centro de recogida RAEE
 Send the materials to a WEEE collection centre
 Envoyer les matériaux dans une déchetterie DEEE
 Inviare i materiali ad un centro di raccolta RAEE
 Die Materialien in einem WEEE-Zentrum entsorgen

