

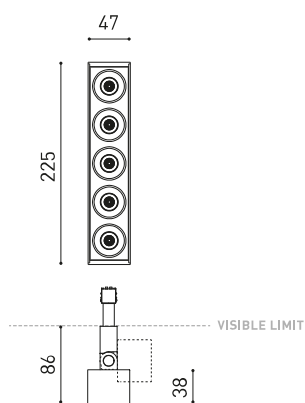

## DIMENSIONES



## ACCESORIOS



TRACK 48V OPTIONS

Nombre	BLACK FOSTER 48V TILT 5 SPOT 4000K WT
Referencia	A4814112WT
Color	Blanco Texturado
RAL	9016
Categoría	TRACKLIGHTS

## FUENTE DE LUZ

Tipo	LED
Flujo Luminoso	1250 lm
Temperatura de color	4000 K
Estabilidad cromática	MacAdam Step 3
Índice de reproducción cromática	CRI > 90
Potencia	10,5 W
Corriente	700 mA
Eficacia	119 lm/W
Horas de Vida del LED	L90B10 > 102.000h

## LUMINARIA | DATOS FOTOMÉTRICOS

Eficiencia Lumínica	90%
Ángulo del haz de luz	19°

## LUMINARIA | DATOS ELÉCTRICOS

Driver	Incluido
Potencia del sistema	11,71 W
Tensión	48Vdc
Regulación	No Dim
Clase de seguridad eléctrica	II

## OTROS DATOS

Estanqueidad	IP20
Control inalámbrico	Consultar
Ángulo de basculación	90°
Ángulo de giro	360°
Tipo de carril	Track 48V
Peso	450 g
Peso con embalaje	550 g
Dimensiones embalaje	268 x 172 x 62 mm
Unidades por embalaje	1
Materiales	Aluminio / Acrilonitrilo Butadieno Estireno / Policarbonato

La nueva herramienta de luz Black Foster 48v Tilt ofrece una nueva solución basculante al carril track 48V de 90° a 360°. Gracias a esta nueva función que ofrece Black Foster, la luz se proyecta con libertad, precisión y ángulos creando incitantes escenas.

DIAGRAMA POLAR



DIAGRAMA CÓNICO

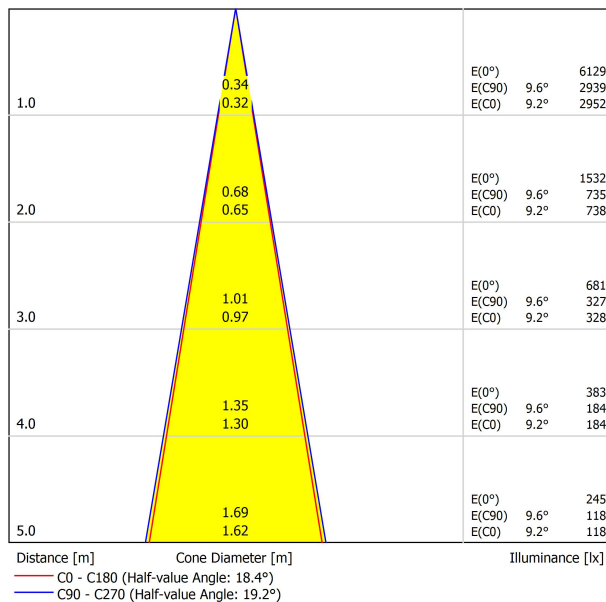



## TRACK 48V TRIMLESS

TRACK 48V TRIMLESS 1m	A338-01-00-   N   WT
TRACK 48V TRIMLESS 2m	A338-02-00-   N   WT
TRACK 48V TRIMLESS 3m	A338-03-00-   N   WT
TRACK 48V TRIMLESS Corner 90° One Plane	A338-06-00-   N   WT
TRACK 48V TRIMLESS Corner 90° Two Planes	A338-07-00-   N   WT

PLASTERBOARD CEILING, MANDATORY THICKNESS 12,5mm.  
RECOMMENDED FOR INSTALLATIONS WHERE THE PROFILE CAN BE  
INSTALLED BEFORE THE FALSE PLASTERBOARD CEILING.



TRIMLESS INSTALLATION GUIDE  
<https://youtu.be/tgGsQdaYe-w>



## TRACK 48V SURFACE

TRACK 48V SURFACE 1m	A338-11-00-   NT   WT
TRACK 48V SURFACE 2m	A338-12-00-   NT   WT
TRACK 48V SURFACE 3m	A338-13-00-   NT   WT
TRACK 48V SURFACE Corner 90° One Plane	A338-14-00-   NT   WT
TRACK 48V SURFACE T-Joint	A338-15-00-   NT
TRACK 48V SURFACE X-Joint	A338-16-00-   NT



## TRACK 48V SURFACE SHORT

TRACK 48V SURFACE SHORT 1m	A338-21-00-   NT   WT
TRACK 48V SURFACE SHORT 2m	A338-22-00-   NT   WT
TRACK 48V SURFACE SHORT 3m	A338-23-00-   NT   WT
TRACK 48V SURFACE SHORT Corner 90° One Plane	A338-24-00-   NT   WT
TRACK 48V SURFACE SHORT T-Joint	A338-25-00-   NT
TRACK 48V SURFACE SHORT X-Joint	A338-26-00-   NT



COLOUR | N ■ RAL 9005 | NT ■ RAL 9005 | WT □ RAL 9016 |

### TRACK 48V TRIMLESS Corner 90° One Plane



\*Electrical connection not included

### TRACK 48V TRIMLESS Corner 90° Two Planes



\*Electrical connection not included



### TRACK 48V SURFACE Corner 90° One Plane



### T-Joint



### X-Joint



Electrical connection not included | Straight joiner included

### TRACK 48V SURFACE SHORT Corner 90° One Plane

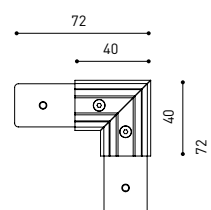

### T-Joint



### X-Joint

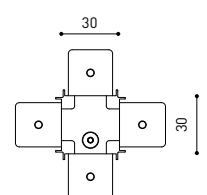

Electrical connection not included | Straight joiner included



CONSTANT VOLTAGE  
LED POWER SUPPLY

	P	V	D (A x B x C)
0434-01-61*   N   W	100W	48V	298 x 19 x 16mm
0434-01-69*   N   W	250W	48V	268 x 22 x 44mm
0434-01-62	150W	48V	350 x 30 x 18mm
0434-01-80	250W	48V	400 x 40 x 22mm

220  
240 V~ | \*To be installed inside the track.

**i** » 282

DROP VOLTAGE TABLE

POWER (W)	CABLE SECTION (mm <sup>2</sup> )	CABLE LENGTH (m)			
		5	10	20	30
100	0,75	50	50	X	X
	1,5	50	50	40	25
150	0,75	40	15	X	X
	1,5	50	40	20	X
250	0,75	20	X	X	X
	1,5	35	20	X	X

LED POWER SUPPLY  
0434-01-61

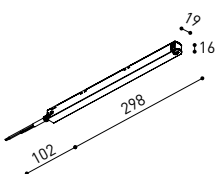

LED POWER SUPPLY  
0434-01-69 \*\*

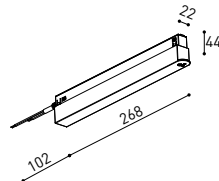

LED POWER SUPPLY  
0434-01-62

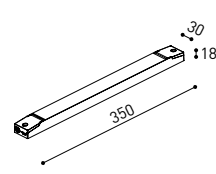

LED POWER SUPPLY  
0434-01-80

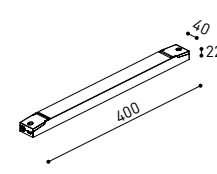

\*\*Not recommended for Track 48V Surface Short

ALL 48V TRACK



Live-End Connector 48V  
A338-00-01- | N | W |

L-Joint Connector 48V  
A338-00-12- | N | W |

T-Joint Connector 48V  
A450-00-07- | N |

Wireless Control 48V  
0434-01-31- | N | W | Casambi/AAG Stucchi App



Central Connector 48V  
A338-00-02- | N | W |



Corner 90° Connector One Plane 48V  
A338-00-24- | N | W |

\*Not suitable for trimless version



X-Joint Connector 48V  
A450-00-08- | N |



Cover Gap 1m 48V  
A338-00-30- | N | W |

TRIMLESS 48V

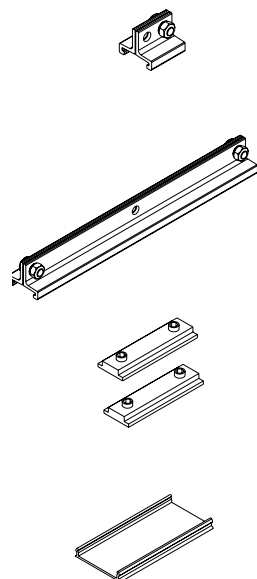

Trimless T-Bracket 48V  
A338-00-03

Trimless Long T-Bracket 48V  
A338-00-04

Trimless Straight Joiner 48V (2 Units)  
A338-00-05- | N | WT |

Trimless Plaster Installation Guard 1m 48V  
A338-00-21



Trimless Clamp for M6 ROD 48V  
A338-00-09

\*See accessories quantities



Trimless Track Clamp 48V  
A338-00-10

\*See accessories quantities



Trimless Suspension Kit 48V  
A338-00-08

\*See accessories quantities

\* SUGGESTED MOUNTING ACCESSORIES QUANTITIES

- 1000mm - 2 Pcs.
- 2000mm - 3 Pcs.
- 3000mm - 4 Pcs.

COLOUR | N ■ RAL 9005 | W □ RAL 9016 | NT ■ RAL 9005 | WT □ RAL 9016 |

## TRIMLESS, SURFACE & SUSPENSION 48V



**End 48V**  
A338-00-06- | NT | WT |



**End feed 48V**  
A338-00-07- | NT | WT |

## SURFACE & SUSPENSION SHORT 48V



**Short End 48V**  
A338-00-18- | NT | WT |



**Short End feed 48V**  
A338-00-19- | NT | WT |

## SURFACE & SURFACE SHORT 48V



**Power Supply Case 48V**  
A338-00-29- | NT | WT | 150 W

220 V ~ 240 V ~ To be installed aside 48V Surface Tracks  
INCL



**Surface Straight Joiner 48V**  
A338-00-11

## SUSPENSION & SUSPENSION SHORT 48V



**Wired Power Supply Case 48V**

A338-00-25- | NT | WT | 150 W NO DIM  
A338-00-26- | NT | WT | 150 W DIM

220 V ~ 240 V ~ INCL

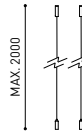

**Suspension Kit 48V (2 units)**  
A338-00-15- | NT | WT |



**Suspension Feed Kit 48V**

A338-00-16- | N | W | NO DIM  
A338-00-17- | N | W | DIM

For remote power supply

A338-00-27- | N | W | NO DIM  
A338-00-28- | N | W | DIM

For power supply inside the track

## WIRE TRIMLESS ACCESSORIES



**FEED**

**MAINS TRIMLESS\***  
A023-00-01- | W | N | NO DIM

**MAINS THICK TRIMLESS\***  
A023-00-02- | W | N | DIM



**FASTENING**

**STEEL CABLE TRIMLESS\***  
A023-00-05- | W | N |

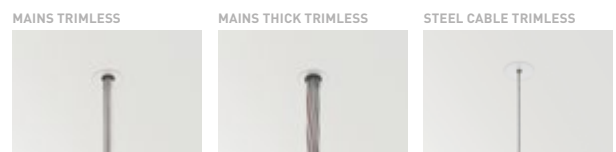

\* AS MANY PIECES AS NEEDED ACCORDING TO YOUR PRODUCT

COLOUR | N ■ RAL 9005 | W □ RAL 9016 | NT ■ RAL 9005 | WT □ RAL 9016 |



Fuente de luz (LED) reemplazable por un profesional autorizado

Replaceable (LED only) light source by an authorized professional.

Source lumineuse (LED) remplaçable par un professionnel agréé

Sorgente luminosa (LED) sostituibile da parte di un professionista autorizzato

Austauschbare (LED) Lichtquelle durch einen autorisierten Fachmann



Equipo de control reemplazable por un profesional autorizado

Replaceable control gear by an authorized professional

Dispositif de commande remplaçable par un professionnel agréé

Alimentatore sostituibile da parte di un professionista autorizzato

Auswechselbares Betriebsgerät durch autorisierten Fachmann

INSTRUCCIONES PARA EL FINAL DE VIDA Y LA ELIMINACIÓN LOS COMPONENTES  
 INSTRUCTIONS ON END-OF-LIFE AND COMPONENT DISPOSAL  
 INSTRUCTIONS POUR LA GESTION DES COMPOSANTS EN FIN DE VIE ET LEUR MISE AU REBUT  
 ISTRUZIONI PER IL FINE VITA E LO SMALTIMENTO DEI COMPONENTI  
 ANWEISUNGEN ZUR ENTSORGUNG DER LEUCHTENKOMPONENTEN



Interrumpir la alimentación del aparato  
 Cut the power supply to the luminaire  
 Couper l'alimentation du luminaire  
 Interrompere l'alimentazione dell'apparecchio  
 Stromversorgung der Leuchte unterbrechen



Quitar la(s) fuente(s) de luz para el desecho  
 Remove light source(s) for disposal  
 Retirer la (les) source(s) lumineuse(s) pour l'élimination  
 Rimuovere la/le sorgente/e di luce per lo smaltimento  
 Lichtquelle(n) zur Entsorgung entfernen



Quitar la batería para el desecho  
 Remove the battery for decommissioning  
 Retirer la batterie pour sa mise au rebut  
 Rimuovere la batteria per la dismissione  
 Die Batterie ordnungsgemäß entsorgen



Quitar el equipo de control para el desecho  
 Remove control gear for disposal  
 Retirer le dispositif de commande pour l'élimination  
 Rimuovere l'alimentatore per lo smaltimento  
 Betriebsgerät zur Entsorgung ausbauen



Enviar los materiales a un centro de recogida RAEE  
 Send the materials to a WEEE collection centre  
 Envoyer les matériaux dans une déchetterie DEEE  
 Inviare i materiali ad un centro di raccolta RAEE  
 Die Materialien in einem WEEE-Zentrum entsorgen

