



DIMENSIONES



ACCESORIOS



CORD ACCESSORY

Nombre	DUNE 35 3M DIM PH.CUT 3000K PG
Referencia	A4820151PG
Color	Gris Guijarro Texturizado - Otros colores, consultar
Color Base	Negro Texturado
RAL	7032
Categoría	SUSPENSION

PRODUCTO

Tipo	LED
Flujo Luminoso	600 lm
Temperatura de color	3000 K - Otros K, consultar
Estabilidad cromática	MacAdam Step 2
Índice de reproducción cromática	CRI > 90
Potencia	4 W
Corriente	120 mA
Eficacia	150 lm/W
Horas de Vida del LED	L90B10 > 55.000h

FUENTE DE LUZ

Eficiencia Lumínica	74%
Ángulo del haz de luz	132°

LUMINARIA | DATOS FOTOMÉTRICOS

Driver	Incluido
Potencia del sistema	5,25 W
Tensión	220V/240V
Frecuencia	50/60 Hz
Regulación	Recorte de Fase - Otros DIM, consultar
Clase de seguridad eléctrica	<input type="checkbox"/>

LUMINARIA | DATOS ELÉCTRICOS

Estanqueidad	IP20
Control inalámbrico	Consultar
Medidas de empotramiento	Ø50 mm
Longitud del cable	Max. 3 m
Tensor de regulación rápida	No
Peso	820 g
Peso con embalaje	1266 g
Dimensiones embalaje	622 x 584 x 135 mm
Unidades por embalaje	1
Materiales	Aluminio / Policarbonato

OTROS DATOS



La luminaria de suspensión Dune viste la luz y construye el espacio con una silueta cónica, clásica y liviana. Su lenguaje entre lo técnico y lo decorativo, redefine este arquetipo con una geometría pura de cantos aguzados cuál papel plegado, y una luz proyectada plácida y homogénea que invita al disfrute.

DIAGRAMA POLAR



DIAGRAMA CÓNICO

Distance [m]	Cone Diameter [m]	Illuminance [lx]
1.0	4.47	E(0°) 135
	4.49	E(C90) 65.9° 5
		E(C0) 66.0° 5
2.0	8.94	E(0°) 34
	8.98	E(C90) 65.9° 1
		E(C0) 66.0° 1
3.0	13.41	E(0°) 15
	13.48	E(C90) 65.9° 1
		E(C0) 66.0° 1
4.0	17.88	E(0°) 8
	17.97	E(C90) 65.9° 0
		E(C0) 66.0° 0
5.0	22.36	E(0°) 5
	22.46	E(C90) 65.9° 0
		E(C0) 66.0° 0

Distance [m] Cone Diameter [m] Illuminance [lx]

— C0 - C180 (Half-value Angle: 132.0°)

— C90 - C270 (Half-value Angle: 131.8°)



PRODUCT	
Model	Cord Accessory
Reference	0223-00-00 N
Colour	N ■ RAL9005
Category	Accessories

DIMENSIONAL DRAWING

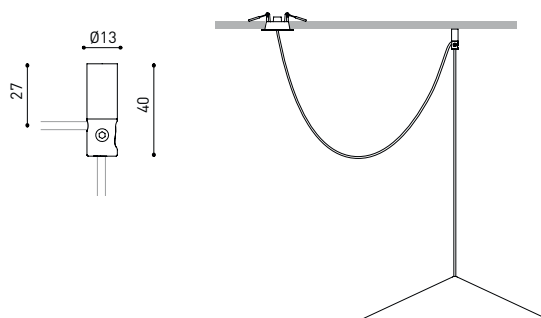



DRIVER

0001-01-03 DRIVER LED 7W 100/120/155/180mA DIM PH.CUT

PHASE CUT DIMMERS TESTED FOR COMPATIBILITY:

Brand / Manufacturer	Model number	Dimming Type
Busch	2247U	Leading edge
Busch	6523 U	Leading edge
Busch	6513U-102	Trailing edge
Clipsal	32E450TM	Trailing edge
Clipsal*	32E450LM	Leading edge
Feller	4060.RL	Leading edge
HPM	Cat 200L	Leading edge
Legrand	Cat 400L	Trailing edge
Legrand	67083	Trailing edge
Legrand	770062	Trailing edge
NIKO	310-01900	Trailing edge
NIKO	330-00700	Trailing edge
NIKO	310-02700	Trailing edge
NIKO	310-02800	Trailing edge
OSRAM	MCU Te250	Trailing edge
Siemens	5TC8 284	Trailing edge
DIGINET	MEDM/LED Smart phase adaptive dimmer 400W	Trailing edge
CLIPSAL	32ELEDM	Trailing edge
Hager B&R	WBMD400LED	Trailing edge
V-PRO	250W MAX. GLS	Trailing edge
ELKO*	316 GLED	Leading edge
SG		Trailing edge
Hamilton	LEDIT-B100	Trailing edge
VARILIGHT	JQP401W	Trailing edge
VARILIGHT	KQP221W	Leading edge
VLTIMATE	GU6012L	Trailing edge
Hager B&R	WK060	Leading edge
SHUTTLE	SDIM-T-LED500W	Leading edge
RADIANT	LEDDIMO4-500W	Trailing edge
GIRA	238500%	Trailing /Leading edge
ABB	652300%	Leading edge
JUNG	1224	Trailing /Leading edge

THE PARTICULAR CONDITIONS OF EACH INSTALLATION AND THE SPECIFICATIONS AND CONDITIONS OF USE OF EACH REGULATOR, MAY DIFFER FROM THOSE CONSIDERED IN THE COMPATIBILITY TESTING, AND AFFECT ITS PERFORMANCE IN SAID INSTALLATION.

* FUNCTIONALITY AT THE MINIMUM LOAD TO BE CHECKED



Fuente de luz (LED) reemplazable por un profesional autorizado

Replaceable (LED only) light source by an authorized professional.

Source lumineuse (LED) remplaçable par un professionnel agréé

Sorgente luminosa (LED) sostituibile da parte di un professionista autorizzato

Austauschbare (LED) Lichtquelle durch einen autorisierten Fachmann



Equipo de control reemplazable por un profesional autorizado

Replaceable control gear by an authorized professional

Dispositif de commande remplaçable par un professionnel agréé

Alimentatore sostituibile da parte di un professionista autorizzato

Auswechselbares Betriebsgerät durch autorisierten Fachmann

INSTRUCCIONES PARA EL FINAL DE VIDA Y LA ELIMINACIÓN LOS COMPONENTES
 INSTRUCTIONS ON END-OF-LIFE AND COMPONENT DISPOSAL
 INSTRUCTIONS POUR LA GESTION DES COMPOSANTS EN FIN DE VIE ET LEUR MISE AU REBUT
 ISTRUZIONI PER IL FINE VITA E LO SMALTIMENTO DEI COMPONENTI
 ANWEISUNGEN ZUR ENTSORGUNG DER LEUCHTENKOMPONENTEN



Interrumpir la alimentación del aparato
 Cut the power supply to the luminaire
 Couper l'alimentation du luminaire
 Interrompere l'alimentazione dell'apparecchio
 Stromversorgung der Leuchte unterbrechen



Quitar la(s) fuente(s) de luz para el desecho
 Remove light source(s) for disposal
 Retirer la (les) source(s) lumineuse(s) pour l'élimination
 Rimuovere la/le sorgente/e di luce per lo smaltimento
 Lichtquelle(n) zur Entsorgung entfernen



Quitar la batería para el desecho
 Remove the battery for decommissioning
 Retirer la batterie pour sa mise au rebut
 Rimuovere la batteria per la dismissione
 Die Batterie ordnungsgemäß entsorgen



Quitar el equipo de control para el desecho
 Remove control gear for disposal
 Retirer le dispositif de commande pour l'élimination
 Rimuovere l'alimentatore per lo smaltimento
 Betriebsgerät zur Entsorgung ausbauen



Enviar los materiales a un centro de recogida RAEE
 Send the materials to a WEEE collection centre
 Envoyer les matériaux dans une déchetterie DEEE
 Inviare i materiali ad un centro di raccolta RAEE
 Die Materialien in einem WEEE-Zentrum entsorgen

