

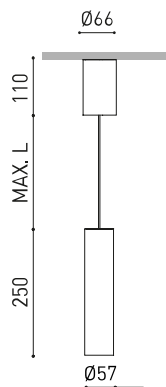

Dimensions



Accessories



CORD ACCESSORY

Name	PIPE BASE 5M FLOOD DIM DALI 2700K NTMG
Reference	A4882210NTMG
Colour	Textured black-Metallized gold
Base Finishing	Textured black
RAL	Metallic finish
Category	SUSPENSION

PRODUCT

Type	LED
Gross luminous flux	620 lm
Colour temperature	2700 K
Chromatic stability	MacAdam Step 2
Colour Rendering Index	CRI>90
Power	6 W
Current	500 mA
Efficacy	103 lm/W
LED lifespan	L80B10 >60.000h
Energy efficiency class	F

LIGHT SOURCE

Lighting efficiency	78%
Light beam angle	34°

LIGHTING FIXTURE | PHOTOMETRIC DATA

Driver	Included
Power values of the system	7,89 W
Frequency	50/60 Hz
Dimming	DALI - Other DIM, please consult
Electrical insulation class	<input type="checkbox"/>

LIGHTING FIXTURE | ELECTRICAL DATA

Sealing	IP20
Wireless control	Please Consult
Cord length	Max. 5 m
Fast adjustment tensioner	No
Weight	695 g
Packaged weight	830 g
Packaging dimensions	319 x 148 x 77 mm
Units per package	1
Materials	Aluminium / Acrylonitrile Butadiene Styrene / Polycarbonate

OTHER DATA



Pipe is created from the harmony of fine lines and geometric shapes. With a more compact body and the incorporation of 'The Invisible Black' effect, which contemplates its composition by playing with units by arrangement and height.

Polar diagram

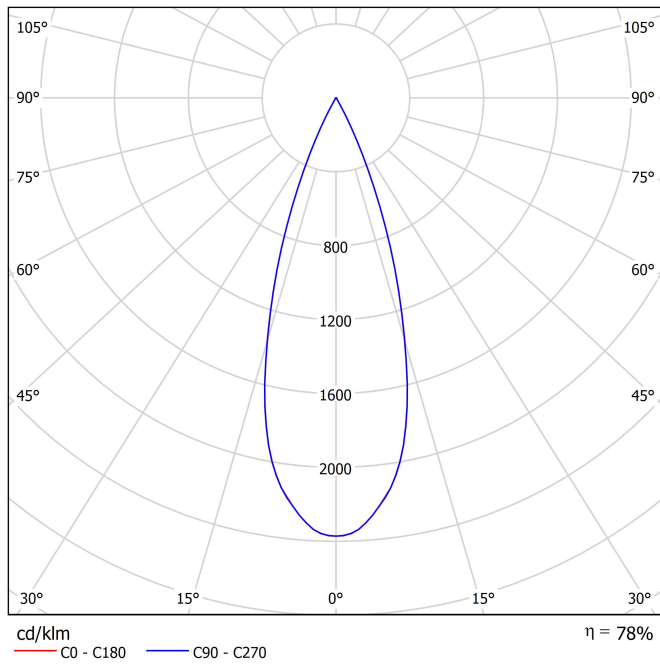

Conical diagram

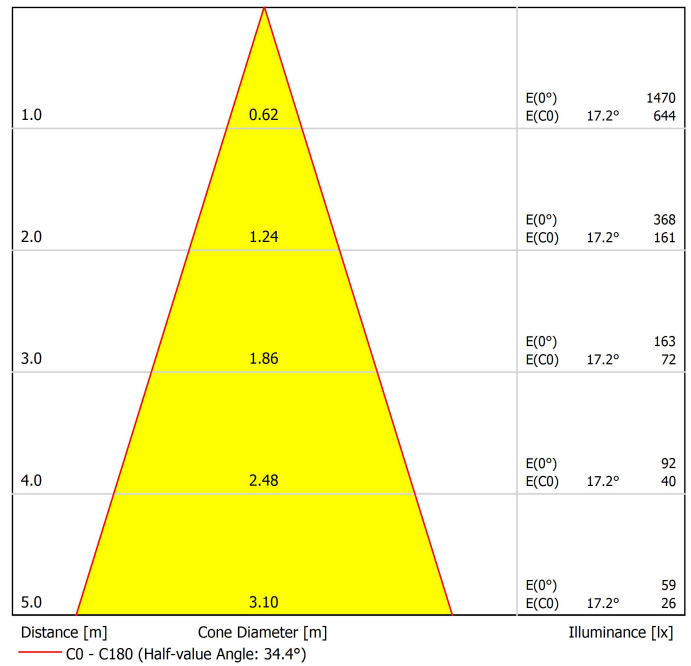

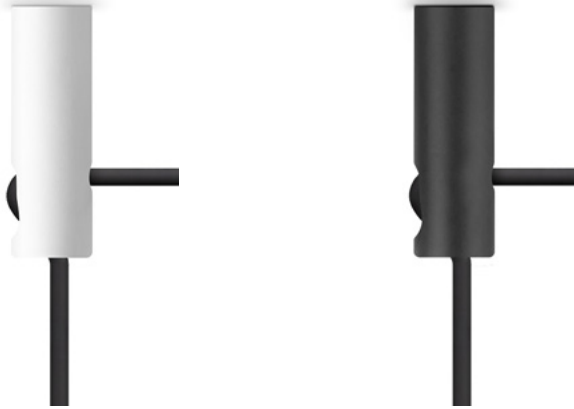

PRODUCT	
Model	Cord Accessory
Reference	0223-00-00 W N
Colour	W <input type="checkbox"/> RAL 9016 N <input type="checkbox"/> RAL9005
Category	Accessories

Dimensional drawing

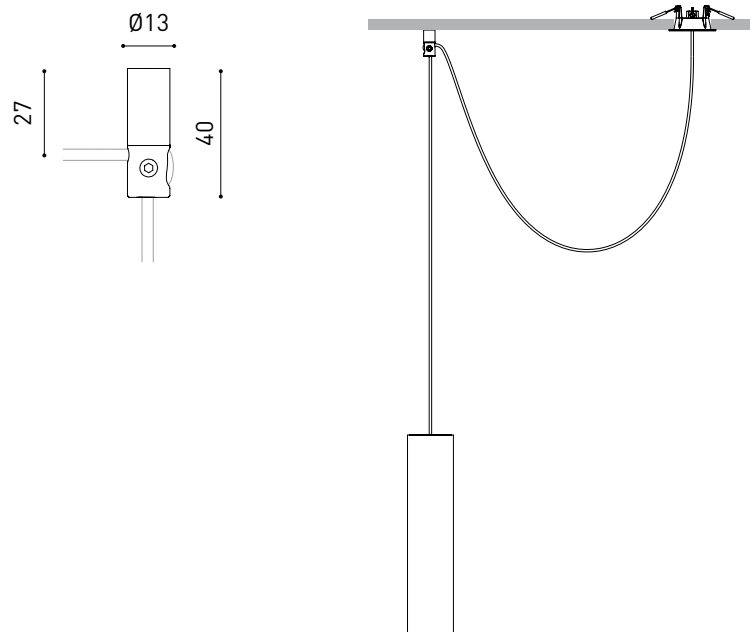

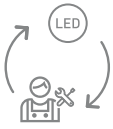

Fuente de luz (LED) reemplazable por un profesional autorizado

Replaceable (LED only) light source by an authorized professional.

Source lumineuse (LED) remplaçable par un professionnel agréé

Sorgente luminosa (LED) sostituibile da parte di un professionista autorizzato

Austauschbare (LED) Lichtquelle durch einen autorisierten Fachmann



Equipo de control reemplazable por un profesional autorizado

Replaceable control gear by an authorized professional

Dispositif de commande remplaçable par un professionnel agréé

Alimentatore sostituibile da parte di un professionista autorizzato

Auswechselbares Betriebsgerät durch autorisierten Fachmann

Instrucciones para el final de vida y la eliminación de los componentes:

Instructions on end-of-life and component disposal:

Instructions pour la gestion des composants en fin de vie et leur mise au rebut :

Istruzioni per il fine vita e lo smaltimento dei componenti:

Anweisungen zur entsorgung der Leuchtenkomponenten:



Interrumpir la alimentación del aparato
Cut the power supply to the luminaire
Couper l'alimentation du luminaire
Interrompere l'alimentazione dell'apparecchio
Stromversorgung der Leuchte unterbrechen



Quitar la(s) fuente(s) de luz para el desecho
Remove light source(s) for disposal
Retirer la (les) source(s) lumineuse(s) pour l'élimination
Rimuovere la/le sorgente/e di luce per lo smaltimento
Lichtquelle(n) zur Entsorgung entfernen

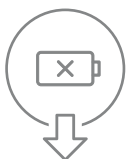

Quitar la batería para el desecho
Remove the battery for decommissioning
Retirer la batterie pour sa mise au rebut
Rimuovere la batteria per la dismissione
Die Batterie ordnungsgemäß entsorgen



Quitar el equipo de control para el desecho
Remove control gear for disposal
Retirer le dispositif de commande pour l'élimination
Rimuovere l'alimentatore per lo smaltimento
Betriebsgerät zur Entsorgung ausbauen



Enviar los materiales a un centro de recogida RAEE
Send the materials to a WEEE collection centre
Envoyer les matériaux dans une déchetterie DEEE
Inviare i materiali ad un centro di raccolta RAEE
Die Materialien in einem WEEE-Zentrum entsorgen

