

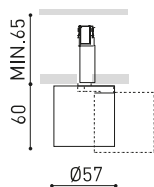

## DIMENSIONI



## ACCESSORI

MAGNETIC CONNECTOR  
(MANDATORY)

TRIMLESS TOOL



DRIVER OPTIONS

Nome	MAGNETIC 24V FLIP SPOT 2700K NT
Articolo	A4920010NT
Colore	Nero Strutturato - Altri colori, consultare
RAL	9005
Categoria	CEILING RECESSED

## PRODOTTO

Tipo	LED
Flusso luminoso lordo	640 lm
Temperatura di colore	2700 K
Stabilità cromatica	MacAdam Step 2
Indice di Riproduzione Cromatica	CRI > 90
Potenza	6 W
Corrente	500 mA
Efficienza	107 lm/W
Ore di vita del LED	L80B10 > 50.000h

## SORGENTE DI LUCE

Efficienza luminosa	89%
Angolo del fascio di luce	18°

## APPARECCHIO | DATI FOTOMETRICI

Driver	Incluso
Valori di potenza del sistema	6,79 W
Tensione	24Vdc
Regolazione	Opzioni DIM
Classe di isolamento elettrico	II

## APPARECCHIO | DATI ELETTRICI

Tenuta stagna	IP20
Wireless control	Consultare
Angolo di oscillazione	90°
Angolo di rotazione	360°
Peso	175 g
Peso compresso l'imballaggio	225 g
Dimensioni dell'imballaggio	96 x 91 x 103 mm
Unità per imballaggio	1
Materiali	Alluminio / Acrilnitrile Butadiene Stirene / Policarbonato

## ALTRI DATI



Grazie a un esercizio quasi mimico rispetto agli elementi architettonici, la versione Flip Magnetic rappresenta la forma più elementare della sua famiglia. Un apparecchio di illuminazione incassato nel soffitto che nasconde la sua base e offre alla vista il suo corpo cilindrico in movimento.

DIAGRAMMA DI ABBAGLIAMENTO POLARE



DIAGRAMMA CONICO



# MAGNETIC 24V CONNECTOR

ARKOSLIGHT®

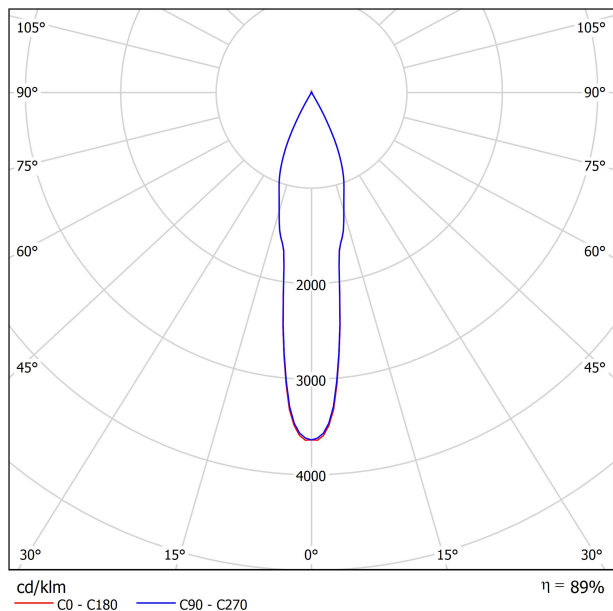
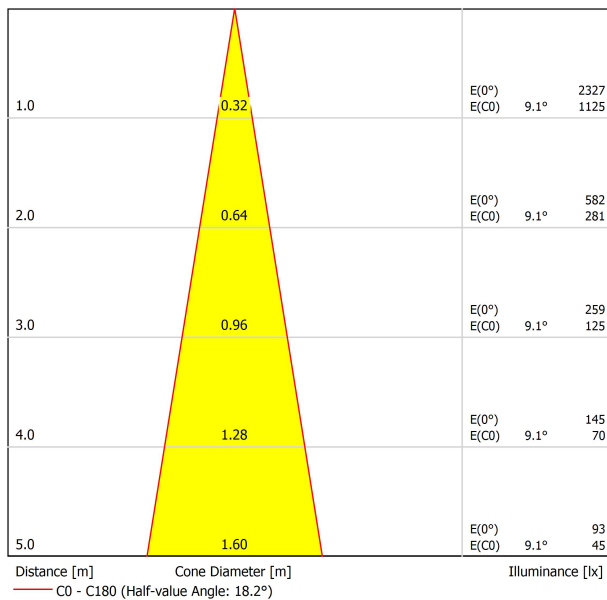
MANDATORY FOR INSTALLATION

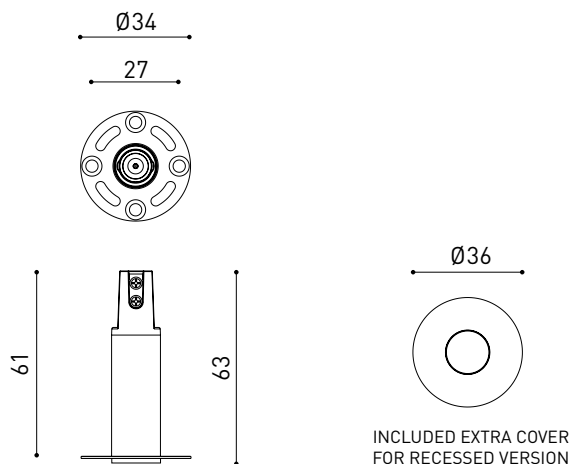

PRODUCT	
Model	Magnetic connector accessory
Reference	A435-01- 00   W <input type="checkbox"/>   N <input checked="" type="checkbox"/>
Category	Accessories



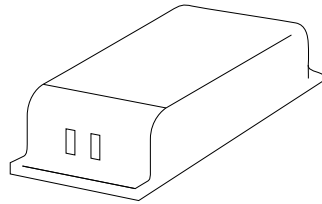

			P	V	D (A x B x C)
24V POWER SUPPLY	ON/OFF	0434-01-37	60W	24V	180 x 52 x 30mm
		0433-10-22	100W	24V	295 x 43 x 30mm

220 V~  
240 V~

MUST BE PLACED ON REMOTE

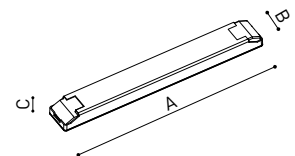

				V	D (A x B x C)
24V Dimmer		0433-01-32	DALI/PUSH	24V	181 x 42 x 20mm
		0433-01-35	CASAMBI	24V	72,6 x 30 x 18mm
		0434-01-64	WIFI	24V	105 x 44 x 23mm

24V

MUST BE PLACED ON REMOTE

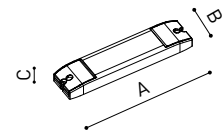

### DROP VOLTAGE TABLE

POWER (W)	CABLE SECTION (mm <sup>2</sup> )	CABLE LENGHT (m)
60	0,75	30
	1,5	30
100	0,75	20
	1,5	30

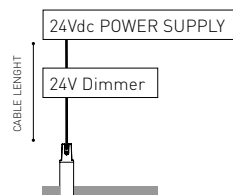



INSTALLATION GUIDE

[https://youtu.be/sa\\_xAgj4ji4](https://youtu.be/sa_xAgj4ji4)

## PRODUCT

Model	Trimless Tool <b>D16 X D34 MM</b>
Reference	A478-00-00
Category	Accessories

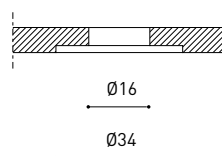
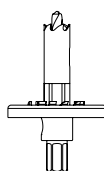



Fuente de luz (LED) reemplazable por un profesional autorizado

Replaceable (LED only) light source by an authorized professional.

Source lumineuse (LED) remplaçable par un professionnel agréé

Sorgente luminosa (LED) sostituibile da parte di un professionista autorizzato

Austauschbare (LED) Lichtquelle durch einen autorisierten Fachmann



Equipo de control reemplazable por un profesional autorizado

Replaceable control gear by an authorized professional

Dispositif de commande remplaçable par un professionnel agréé

Alimentatore sostituibile da parte di un professionista autorizzato

Auswechselbares Betriebsgerät durch autorisierten Fachmann

INSTRUCCIONES PARA EL FINAL DE VIDA Y LA ELIMINACIÓN LOS COMPONENTES  
 INSTRUCTIONS ON END-OF-LIFE AND COMPONENT DISPOSAL  
 INSTRUCTIONS POUR LA GESTION DES COMPOSANTS EN FIN DE VIE ET LEUR MISE AU REBUT  
 ISTRUZIONI PER IL FINE VITA E LO SMALTIMENTO DEI COMPONENTI  
 ANWEISUNGEN ZUR ENTSORGUNG DER LEUCHTENKOMPONENTEN



Interrumpir la alimentación del aparato  
 Cut the power supply to the luminaire  
 Couper l'alimentation du luminaire  
 Interrompere l'alimentazione dell'apparecchio  
 Stromversorgung der Leuchte unterbrechen



Quitar la(s) fuente(s) de luz para el desecho  
 Remove light source(s) for disposal  
 Retirer la (les) source(s) lumineuse(s) pour l'élimination  
 Rimuovere la/le sorgente/e di luce per lo smaltimento  
 Lichtquelle(n) zur Entsorgung entfernen



Quitar la batería para el desecho  
 Remove the battery for decommissioning  
 Retirer la batterie pour sa mise au rebut  
 Rimuovere la batteria per la dismissione  
 Die Batterie ordnungsgemäß entsorgen



Quitar el equipo de control para el desecho  
 Remove control gear for disposal  
 Retirer le dispositif de commande pour l'élimination  
 Rimuovere l'alimentatore per lo smaltimento  
 Betriebsgerät zur Entsorgung ausbauen



Enviar los materiales a un centro de recogida RAEE  
 Send the materials to a WEEE collection centre  
 Envoyer les matériaux dans une déchetterie DEEE  
 Inviare i materiali ad un centro di raccolta RAEE  
 Die Materialien in einem WEEE-Zentrum entsorgen

