

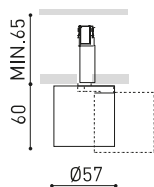

DIMENSIONES



ACCESORIOS



MAGNETIC CONNECTOR
(MANDATORY)



TRIMLESS TOOL



DRIVER OPTIONS

Nombre	MAGNETIC 24V FLIP FLOOD 3000K NTMG
Referencia	A4920021NTMG
Color	Textured black-Metallized gold - Other colours, please consult
RAL	Metallic finish
Categoría	CEILING RECESSED

PRODUCTO

Tipo	LED
Flujo Luminoso	670 lm
Temperatura de color	3000 K
Estabilidad cromática	MacAdam Step 2
Índice de reproducción cromática	CRI > 90
Potencia	6 W
Corriente	500 mA
Eficacia	112 lm/W
Horas de Vida del LED	L80B10 > 50.000h

FUENTE DE LUZ

Eficiencia Lumínica	84%
Ángulo del haz de luz	40°

LUMINARIA | DATOS FOTOMÉTRICOS

Driver	Included
Potencia del sistema	6,79 W
Tensión	24Vdc
Regulación	DIM options
Clase de seguridad eléctrica	II

LUMINARIA | DATOS ELÉCTRICOS

Estanqueidad	IP20
Control inalámbrico	Please Consult
Ángulo de basculación	90°
Ángulo de giro	360°
Peso	175 g
Peso con embalaje	225 g
Dimensiones embalaje	96 x 91 x 103 mm
Unidades por embalaje	1
Materiales	Aluminium / Acrylonitrile Butadiene Styrene / Polycarbonate

OTROS DATOS



In an almost mimic exercise with architectural elements, the Flip Magnetic version represents the simplest form of its product family. A recessed ceiling luminaire which conceals its base and offers a free moving cylindrical body.

DIAGRAMA POLAR



DIAGRAMA CÓNICO



MAGNETIC 24V CONNECTOR

ARKOSLIGHT®

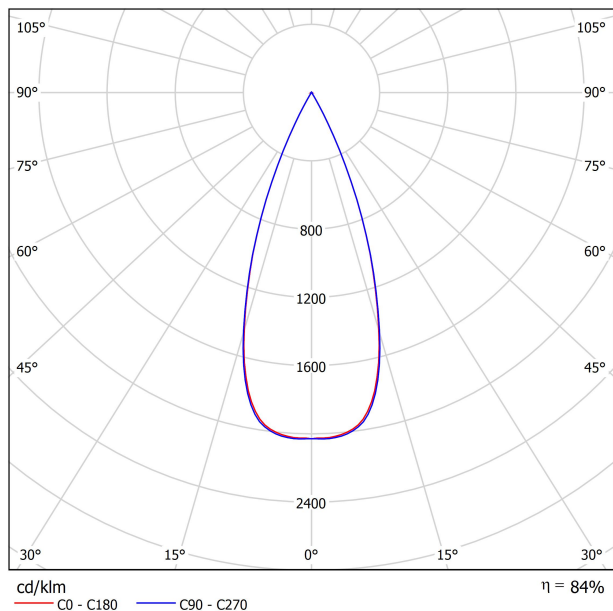
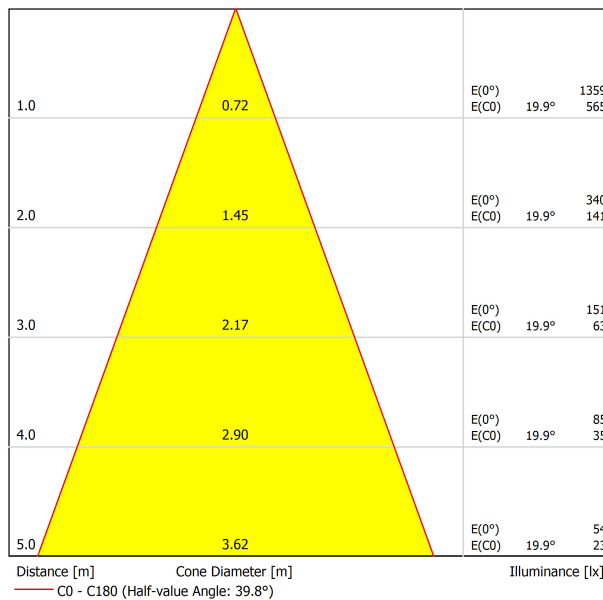
MANDATORY FOR INSTALLATION

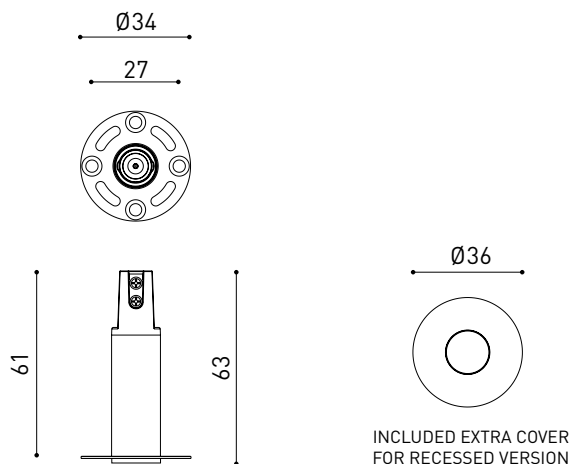

PRODUCT	
Model	Magnetic connector accessory
Reference	A435-01- 00 W <input type="checkbox"/> N <input checked="" type="checkbox"/>
Category	Accessories



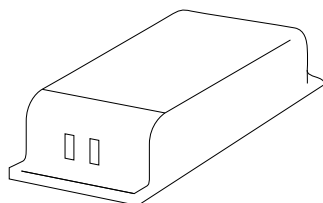

			P	V	D (A x B x C)
24V POWER SUPPLY	ON/OFF	0434-01-37	60W	24V	180 x 52 x 30mm
		0433-10-22	100W	24V	295 x 43 x 30mm

220 V~
240 V~

MUST BE PLACED ON REMOTE

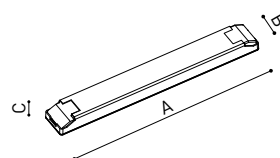

				V	D (A x B x C)
24V Dimmer		0433-01-32	DALI/PUSH	24V	181 x 42 x 20mm
		0433-01-35	CASAMBI	24V	72,6 x 30 x 18mm
		0434-01-64	WIFI	24V	105 x 44 x 23mm

24V

MUST BE PLACED ON REMOTE

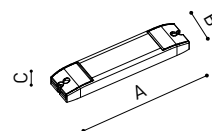

DROP VOLTAGE TABLE

POWER (W)	CABLE SECTION (mm ²)	CABLE LENGHT (m)
60	0,75	30
	1,5	30
100	0,75	20
	1,5	30

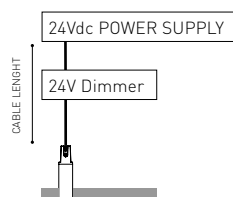



INSTALLATION GUIDE

https://youtu.be/sa_xAgj4ji4

PRODUCT

Model	Trimless Tool D16 X D34 MM
Reference	A478-00-00
Category	Accessories

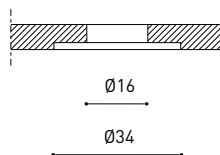
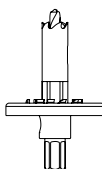



Fuente de luz (LED) reemplazable por un profesional autorizado
 Replaceable (LED only) light source by an authorized professional.
 Source lumineuse (LED) remplaçable par un professionnel agréé
 Sorgente luminosa (LED) sostituibile da parte di un professionista autorizzato
 Austauschbare (LED) Lichtquelle durch einen autorisierten Fachmann



Equipo de control reemplazable por un profesional autorizado
 Replaceable control gear by an authorized professional
 Dispositif de commande remplaçable par un professionnel agréé
 Alimentatore sostituibile da parte di un professionista autorizzato
 Auswechselbares Betriebsgerät durch autorisierten Fachmann

INSTRUCCIONES PARA EL FINAL DE VIDA Y LA ELIMINACIÓN LOS COMPONENTES
 INSTRUCTIONS ON END-OF-LIFE AND COMPONENT DISPOSAL
 INSTRUCTIONS POUR LA GESTION DES COMPOSANTS EN FIN DE VIE ET LEUR MISE AU REBUT
 ISTRUZIONI PER IL FINE VITA E LO SMALTIMENTO DEI COMPONENTI
 ANWEISUNGEN ZUR ENTSORGUNG DER LEUCHTENKOMPONENTEN



Interrumpir la alimentación del aparato
 Cut the power supply to the luminaire
 Couper l'alimentation du luminaire
 Interrompere l'alimentazione dell'apparecchio
 Stromversorgung der Leuchte unterbrechen



Quitar la(s) fuente(s) de luz para el desecho
 Remove light source(s) for disposal
 Retirer la (les) source(s) lumineuse(s) pour l'élimination
 Rimuovere la/le sorgente/e di luce per lo smaltimento
 Lichtquelle(n) zur Entsorgung entfernen

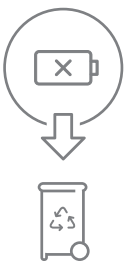

Quitar la batería para el desecho
 Remove the battery for decommissioning
 Retirer la batterie pour sa mise au rebut
 Rimuovere la batteria per la dismissione
 Die Batterie ordnungsgemäß entsorgen



Quitar el equipo de control para el desecho
 Remove control gear for disposal
 Retirer le dispositif de commande pour l'élimination
 Rimuovere l'alimentatore per lo smaltimento
 Betriebsgerät zur Entsorgung ausbauen

Enviar los materiales a un centro de recogida RAEE
 Send the materials to a WEEE collection centre
 Envoyer les matériaux dans une déchetterie DEEE
 Inviare i materiali ad un centro di raccolta RAEE
 Die Materialien in einem WEEE-Zentrum entsorgen

