

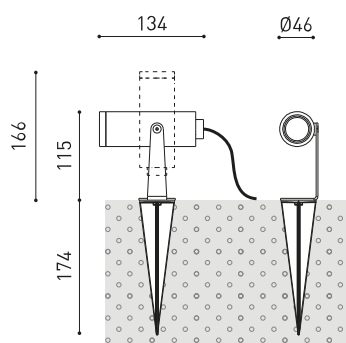

DIMENSIONES



ACCESORIOS



CONNECTOR IP67



ANTI-GLARE SCREEN

Nombre	SKIP MEDIUM 3000K GT
Referencia	A4970121GT
Color	Gris Texturizado
RAL	7021
Categoría	OUTDOOR

PRODUCTO

SKIP MEDIUM 3000K GT

A4970121GT

Gris Texturizado

7021

OUTDOOR

FUENTE DE LUZ

LED

660 lm

3000 K

MacAdam Step 2

CRI > 90

5,5 W

500 mA

120 lm/W

L90B10 > 108.000h

LUMINARIA | DATOS FOTOMÉTRICOS

91%

29°

LUMINARIA | DATOS ELÉCTRICOS

Incluido

6,86 W

220V/240V

50/60 Hz

No Dim

Clase de seguridad eléctrica

OTROS DATOS

IP65

Ángulo de basculación 360°

Ángulo de giro 360°

Uso en exteriores Sí

Peso 510 g

Peso con embalaje 620 g

Dimensiones embalaje 226 x 159 x 90 mm

Unidades por embalaje 1

Materiales

Aluminio / Acrilonitrilo Butadieno Estireno / Policarbonato



Este proyector para exterior aúna simplicidad, funcionalidad y estética. La tímida presencia de un foco instalado con estaca otorga todo el protagonismo al objeto iluminado mediante una luz versátil.

DIAGRAMA POLAR



DIAGRAMA CÓNICO



IP67 CONNECTOR

ARKOSLIGHT

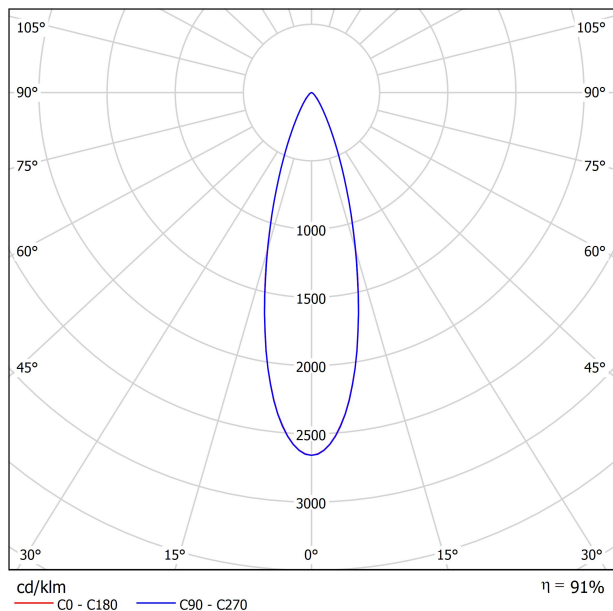
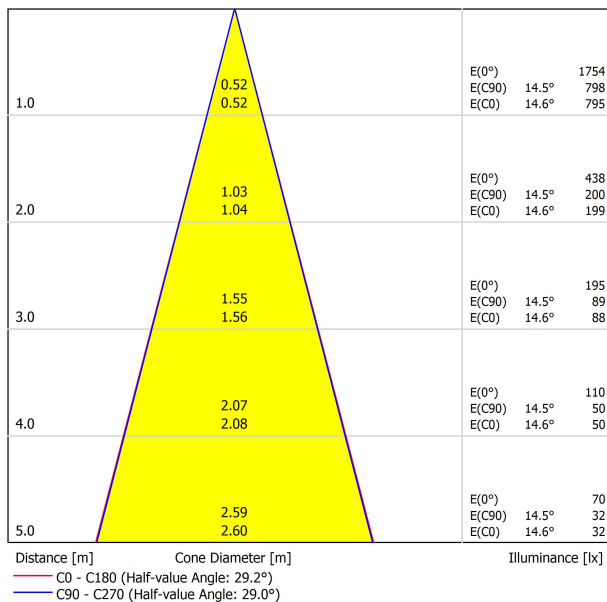
OPTIONAL ACCESSORY

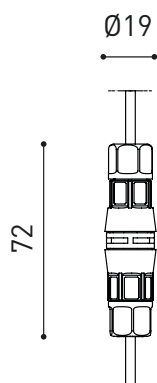

	PRODUCT
Model	Connector IP67 No Dim
Reference	0434-01- 81 N
Category	Accessories

For cable $\varnothing 4,5 - 7,5\text{mm}$ | section $\leq 1,5\text{mm}^2$

IP67 CONNECTOR

ARKOSLIGHT

OPTIONAL ACCESSORY

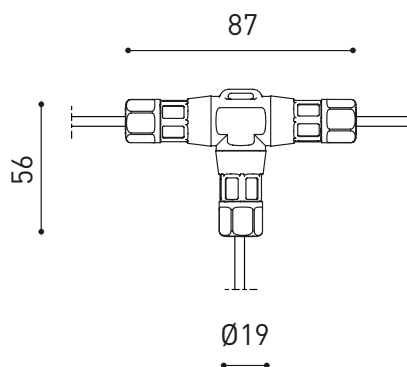

	PRODUCT
Model	Connector IP67 No Dim T-Share
Reference	0434-01- 82 N
Category	Accessories

For cable Ø4,5 -7,5mm | section ≤ 1,5mm²

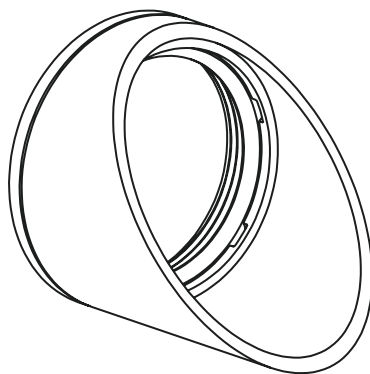

	PRODUCT
Model	SKIP Anti-glare Screen
Reference	A497-00-00 GT OX
Category	Accessories



Fuente de luz (LED) reemplazable por un profesional autorizado

Replaceable (LED only) light source by an authorized professional.

Source lumineuse (LED) remplaçable par un professionnel agréé

Sorgente luminosa (LED) sostituibile da parte di un professionista autorizzato

Austauschbare (LED) Lichtquelle durch einen autorisierten Fachmann



Equipo de control reemplazable por un profesional autorizado

Replaceable control gear by an authorized professional

Dispositif de commande remplaçable par un professionnel agréé

Alimentatore sostituibile da parte di un professionista autorizzato

Auswechselbares Betriebsgerät durch autorisierten Fachmann

INSTRUCCIONES PARA EL FINAL DE VIDA Y LA ELIMINACIÓN LOS COMPONENTES
 INSTRUCTIONS ON END-OF-LIFE AND COMPONENT DISPOSAL
 INSTRUCTIONS POUR LA GESTION DES COMPOSANTS EN FIN DE VIE ET LEUR MISE AU REBUT
 ISTRUZIONI PER IL FINE VITA E LO SMALTIMENTO DEI COMPONENTI
 ANWEISUNGEN ZUR ENTSORGUNG DER LEUCHTENKOMPONENTEN



Interrumpir la alimentación del aparato
 Cut the power supply to the luminaire
 Couper l'alimentation du luminaire
 Interrompere l'alimentazione dell'apparecchio
 Stromversorgung der Leuchte unterbrechen



Quitar la(s) fuente(s) de luz para el desecho
 Remove light source(s) for disposal
 Retirer la (les) source(s) lumineuse(s) pour l'élimination
 Rimuovere la/le sorgente/e di luce per lo smaltimento
 Lichtquelle(n) zur Entsorgung entfernen



Quitar la batería para el desecho
 Remove the battery for decommissioning
 Retirer la batterie pour sa mise au rebut
 Rimuovere la batteria per la dismissione
 Die Batterie ordnungsgemäß entsorgen



Quitar el equipo de control para el desecho
 Remove control gear for disposal
 Retirer le dispositif de commande pour l'élimination
 Rimuovere l'alimentatore per lo smaltimento
 Betriebsgerät zur Entsorgung ausbauen



Enviar los materiales a un centro de recogida RAEE
 Send the materials to a WEEE collection centre
 Envoyer les matériaux dans une déchetterie DEEE
 Inviare i materiali ad un centro di raccolta RAEE
 Die Materialien in einem WEEE-Zentrum entsorgen

