

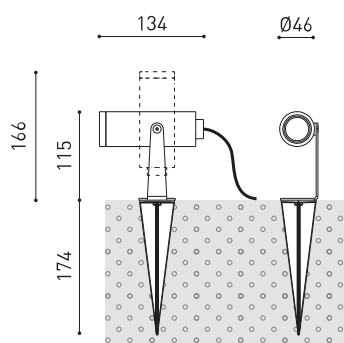

DIMENSIONS



ACCESSORIES



CONNECTOR IP67



ANTI-GLARE SCREEN

PRODUCT

Name	SKIP MEDIUM 3000K OX
Reference	A49701210X
Color	Textured oxidon
Category	OUTDOOR

LIGHT SOURCE

Type	LED
Gross luminous flux	660 lm
Colour temperature	3000 K
Chromatic stability	MacAdam Step 2
Colour Rendering Index	CRI>90
Power	5,5 W
Current	500 mA
Efficacy	120 lm/W
LED lifespan	L90B10 >108.000h

LIGHTING FIXTURE | PHOTOMETRIC DATA

Lighting efficiency	91%
Light beam angle	29°

LIGHTING FIXTURE | ELECTRICAL DATA

Driver	Included
Power values of the system	6,86 W
Frequency	50/60 Hz
Dimming	No Dim
Electrical insulation class	<input type="checkbox"/>

OTHER DATA

Sealing	IP65
Swivel angle	360°
Rotation angle	360°
Outdoor Use	Yes
Weight	510 g
Packaged weight	620 g
Packaging dimensions	226 x 159 x 90 mm
Units per package	1
Materials	Aluminium / Acrylonitrile Butadiene Styrene / Polycarbonate



This outdoor floodlight combines simplicity, functionality and aesthetics. The unassertive presence of a spotlight installed with a stake yields pride of place to the illuminated object by means of a versatile light.

POLAR DIAGRAM

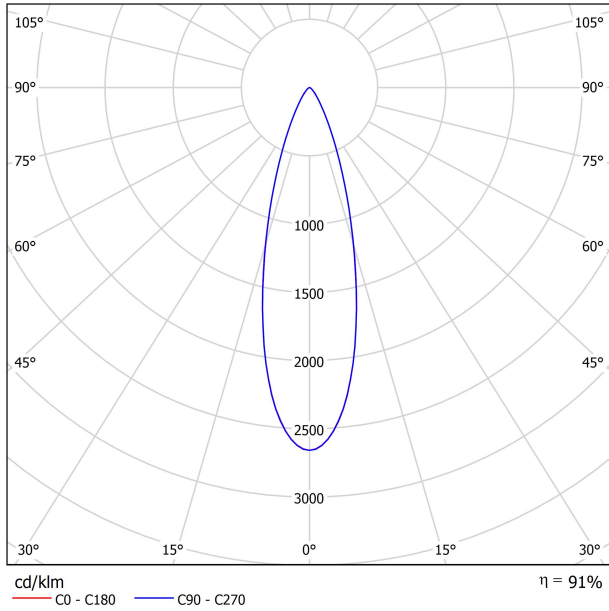

CONICAL DIAGRAM

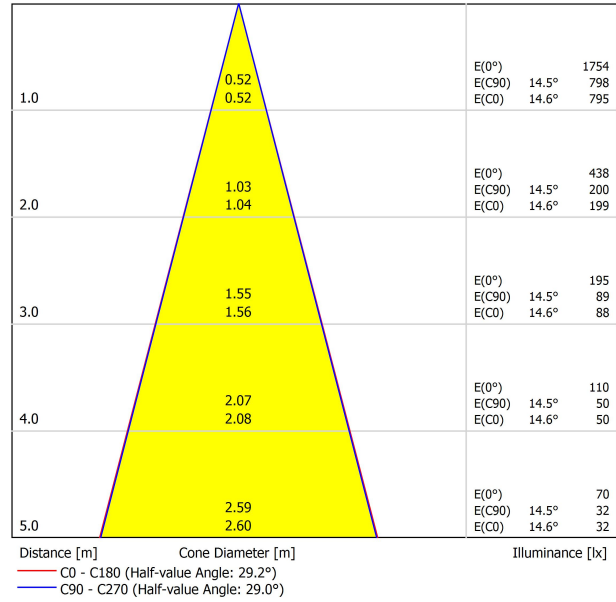

IP67 CONNECTOR

ARKOSLIGHT

OPTIONAL ACCESSORY



	PRODUCT
Model	Connector IP67 No Dim
Reference	0434-01- 81 N
Category	Accessories

For cable $\varnothing 4,5 - 7,5\text{mm}$ | section $\leq 1,5\text{mm}^2$

IP67 CONNECTOR

ARKOSLIGHT

OPTIONAL ACCESSORY



	PRODUCT
Model	Connector IP67 No Dim T-Share
Reference	0434-01- 82 N
Category	Accessories

For cable Ø4,5 -7,5mm | section ≤ 1,5mm²



	PRODUCT
Model	SKIP Anti-glare Screen
Reference	A497-00-00 GT OX
Category	Accessories



Fuente de luz (LED) reemplazable por un profesional autorizado

Replaceable (LED only) light source by an authorized professional.

Source lumineuse (LED) remplaçable par un professionnel agréé

Sorgente luminosa (LED) sostituibile da parte di un professionista autorizzato

Austauschbare (LED) Lichtquelle durch einen autorisierten Fachmann



Equipo de control reemplazable por un profesional autorizado

Replaceable control gear by an authorized professional

Dispositif de commande remplaçable par un professionnel agréé

Alimentatore sostituibile da parte di un professionista autorizzato

Auswechselbares Betriebsgerät durch autorisierten Fachmann

INSTRUCCIONES PARA EL FINAL DE VIDA Y LA ELIMINACIÓN LOS COMPONENTES
 INSTRUCTIONS ON END-OF-LIFE AND COMPONENT DISPOSAL
 INSTRUCTIONS POUR LA GESTION DES COMPOSANTS EN FIN DE VIE ET LEUR MISE AU REBUT
 ISTRUZIONI PER IL FINE VITA E LO SMALTIMENTO DEI COMPONENTI
 ANWEISUNGEN ZUR ENTSORGUNG DER LEUCHTENKOMPONENTEN



Interrumpir la alimentación del aparato
 Cut the power supply to the luminaire
 Couper l'alimentation du luminaire
 Interrompere l'alimentazione dell'apparecchio
 Stromversorgung der Leuchte unterbrechen



Quitar la(s) fuente(s) de luz para el desecho
 Remove light source(s) for disposal
 Retirer la (les) source(s) lumineuse(s) pour l'élimination
 Rimuovere la/le sorgente/e di luce per lo smaltimento
 Lichtquelle(n) zur Entsorgung entfernen



Quitar la batería para el desecho
 Remove the battery for decommissioning
 Retirer la batterie pour sa mise au rebut
 Rimuovere la batteria per la dismissione
 Die Batterie ordnungsgemäß entsorgen



Quitar el equipo de control para el desecho
 Remove control gear for disposal
 Retirer le dispositif de commande pour l'élimination
 Rimuovere l'alimentatore per lo smaltimento
 Betriebsgerät zur Entsorgung ausbauen



Enviar los materiales a un centro de recogida RAEE
 Send the materials to a WEEE collection centre
 Envoyer les matériaux dans une déchetterie DEEE
 Inviare i materiali ad un centro di raccolta RAEE
 Die Materialien in einem WEEE-Zentrum entsorgen

