

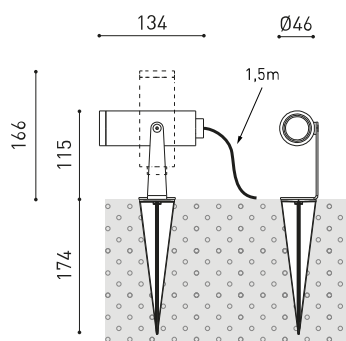

### Dimensioni



### Accessori



DRIVER OPTIONS



CONNECTOR IP67



ANTI-GLARE SCREEN

Nome	SKIP MEDIUM DIM DALI 3000K GT
Articolo	A4970221GT
Colore	Grigio Strutturato
RAL	7021
Categoria	OUTDOOR

Tipo	LED
Flusso luminoso lordo	660 lm
Temperatura di colore	3000 K
Stabilità cromatica	MacAdam Step 2
Indice di Riproduzione Cromatica	CRI > 90
Potenza	5,5 W
Corrente	500 mA
Efficienza	120 lm/W
Ore di vita del LED	L90B10 > 108.000h
Classe di efficienza energetica	F

Efficienza luminosa	91%
Angolo del fascio di luce	29°

Valori di potenza del sistema	6,82 W
Tensione	48Vdc
Regolazione	DALI
Classe di isolamento elettrico	III

Tenuta stagna	IP65
Angolo di oscillazione	360°
Angolo di rotazione	360°
Uso in esterni	Sì
Peso	510 g
Peso compresso l'imballaggio	620 g
Dimensioni dell'imballaggio	226 x 159 x 90 mm
Unità per imballaggio	1
Materiali	Alluminio / Acrilnitrile Butadiene Stirene / Policarbonato

### PRODOTTO

### SORGENTE DI LUCE

### APPARECCHIO | DATI FOTOMETRICI

### APPARECCHIO | DATI ELETTRICI

### ALTRI DATI



Questo proiettore per esterni riunisce semplicità, funzionalità ed estetica. La timida presenza di un proiettore installato con picchetto garantisce il protagonismo all'oggetto illuminato tramite una luce versatile.

Diagramma di abbagliamento polare



Diagramma conico





	P	V	D (A x B x C)
CONSTANT VOLTAGE LED POWER SUPPLY	<b>0434-01-62</b>	150W	48V
			350 x 30 x 18mm
220 240 V~   IP20			Driver must be placed on remote

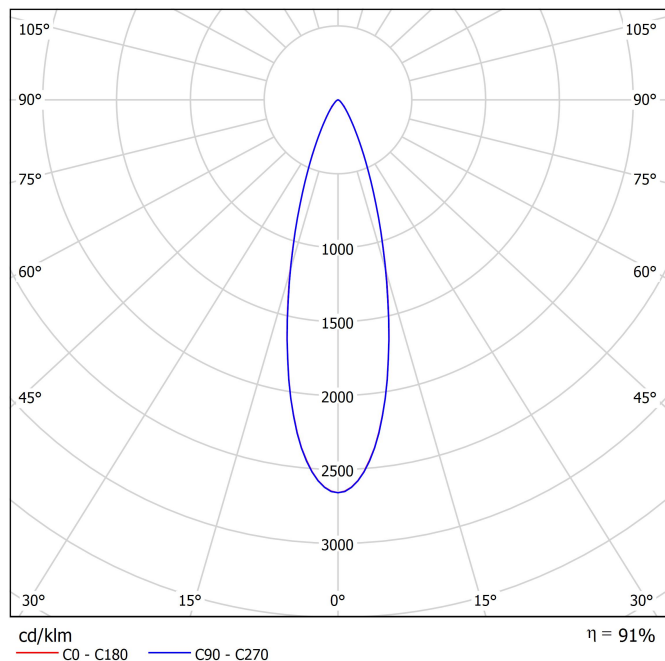
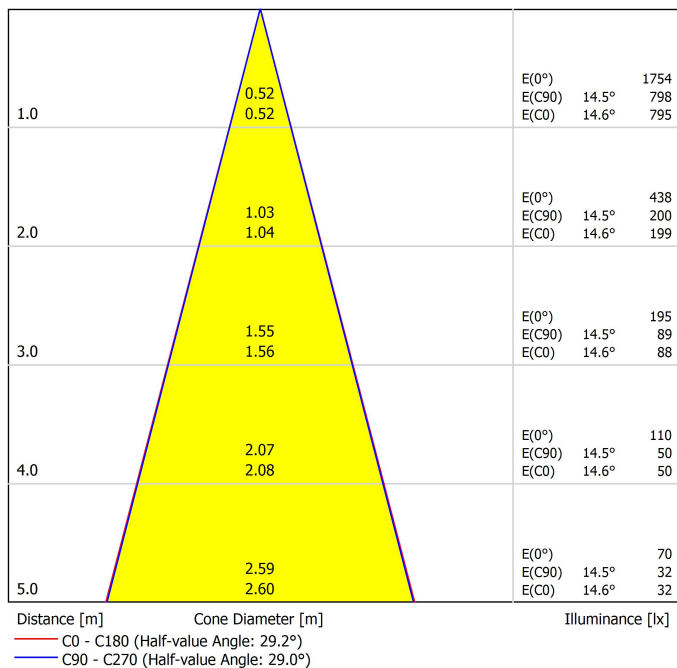
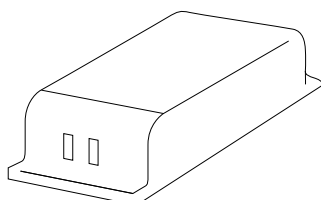
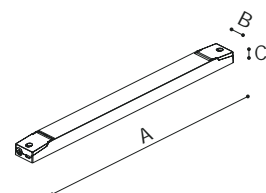

DROPVOLTAGE TABLE

POWER (W)	CABLE SECTION (mm <sup>2</sup> )	CABLE LENGHT (m)			
		<25	<50	<75	<100
150	0,75	✓	✓	✗	✗
	1,0	✓	✓	✓	✗
	1,5	✓	✓	✓	✓

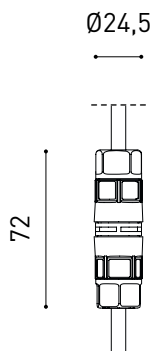

PRODUCT	
Model	Connector IP67 DIM DALI
Reference	0434-01-83-   N
Category	Accessories

For cable Ø5,5-7,5mm, section ≤1,0mm²

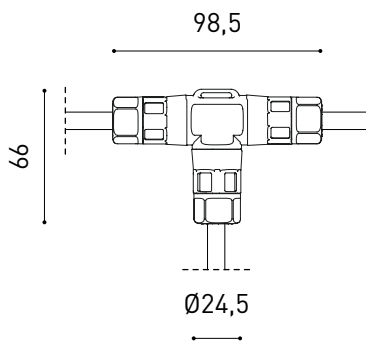

PRODUCT	
Model	Connector IP67 DIM DALI T-Shape
Reference	0434-01-84-   N
Category	Accessories

For cable Ø5,5-7,5mm, section ≤1,0mm²

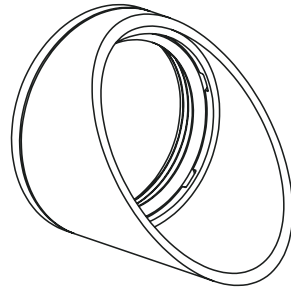

	PRODUCT
Model	SKIP Anti-glare Screen
Reference	<b>A497-00-00   GT   OX  </b>
Category	Accessories
	AFFECTS THE LIGHTING PARAMETERS



Fuente de luz (LED) reemplazable por un profesional autorizado

Replaceable (LED only) light source by an authorized professional.

Source lumineuse (LED) remplaçable par un professionnel agréé

Sorgente luminosa (LED) sostituibile da parte di un professionista autorizzato

Austauschbare (LED) Lichtquelle durch einen autorisierten Fachmann



Equipo de control reemplazable por un profesional autorizado

Replaceable control gear by an authorized professional

Dispositif de commande remplaçable par un professionnel agréé

Alimentatore sostituibile da parte di un professionista autorizzato

Auswechselbares Betriebsgerät durch autorisierten Fachmann

## Instrucciones para el final de vida y la eliminación de los componentes:

### Instructions on end-of-life and component disposal:

### Instructions pour la gestion des composants en fin de vie et leur mise au rebut :

### Istruzioni per il fine vita e lo smaltimento dei componenti:

### Anweisungen zur entsorgung der Leuchtenkomponenten:



Interrumpir la alimentación del aparato  
Cut the power supply to the luminaire  
Couper l'alimentation du luminaire  
Interrompere l'alimentazione dell'apparecchio  
Stromversorgung der Leuchte unterbrechen



Quitar la(s) fuente(s) de luz para el desecho  
Remove light source(s) for disposal  
Retirer la (les) source(s) lumineuse(s) pour l'élimination  
Rimuovere la/le sorgente/e di luce per lo smaltimento  
Lichtquelle(n) zur Entsorgung entfernen



Quitar la batería para el desecho  
Remove the battery for decommissioning  
Retirer la batterie pour sa mise au rebut  
Rimuovere la batteria per la dismissione  
Die Batterie ordnungsgemäß entsorgen



Quitar el equipo de control para el desecho  
Remove control gear for disposal  
Retirer le dispositif de commande pour l'élimination  
Rimuovere l'alimentatore per lo smaltimento  
Betriebsgerät zur Entsorgung ausbauen



Enviar los materiales a un centro de recogida RAEE  
Send the materials to a WEEE collection centre  
Envoyer les matériaux dans une déchetterie DEEE  
Inviare i materiali ad un centro di raccolta RAEE  
Die Materialien in einem WEEE-Zentrum entsorgen

