

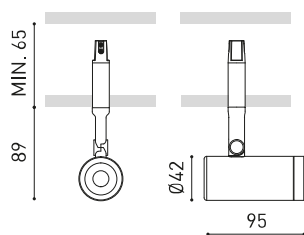

DIMENSIONI

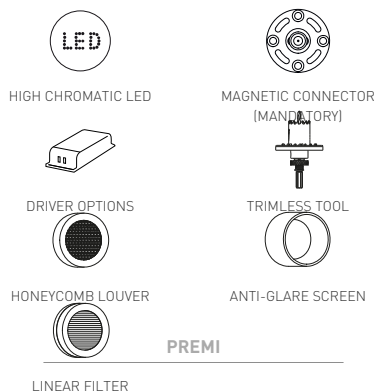

ACCESSORI



Nome	MAGNETIC 24V COCO FLOOD 4000K NT
Articolo	A4990032NT
Colore	Nero Strutturato
RAL	9005
Categoria	CEILING RECESSED

PRODOTTO

MAGNETIC 24V COCO FLOOD 4000K NT
A4990032NT
Nero Strutturato
9005
CEILING RECESSED

SORGENTE DI LUCE

Tipo	LED
Flusso luminoso lordo	1340 lm
Temperatura di colore	4000 K
Stabilità cromatica	MacAdam Step 2
Indice di Riproduzione Cromatica	CRI > 90
Potenza	8,7 W
Efficienza	154 lm/W
Ore di vita del LED	L80B10 > 66.000h

APPARECCHIO | DATI FOTOMETRICI

Efficienza luminosa	86%
Angolo del fascio di luce	48°

APPARECCHIO | DATI ELETTRICI

Valori di potenza del sistema	9,62 W
Tensione	24Vdc
Regolazione	Opzioni DIM
Classe di isolamento elettrico	III

ALTRI DATI

Tenuta stagna	IP20
Wireless control	Consultare
Angolo di oscillazione	90°
Angolo di rotazione	360°
Peso	205 g
Peso compresso l'imballaggio	286 g
Dimensioni dell'imballaggio	210 x 164 x 57 mm
Unità per imballaggio	1
Materiali	Alluminio / Policarbonato / Polimetilmetacrilato

Una soluzione leggera e potente. Coco offre un'eccezionale rapporto lm/W, quattro fasci di luce e vari accessori, per favorire il comfort visivo.

DIAGRAMMA DI ABBAGLIAMENTO POLARE



DIAGRAMMA CONICO



PER PRESENTAZIONE COMMERCIALE DEL PRODOTTO

Vivid Model Colour Temperature	2700K	3000K	3500K	4000K	Light Pink
📖 Reading			•	•	
🥬 Fruits & Vegetables		•	•		
🍞 Bakery	•				
👤 Retail		•	•		
💄 Cosmetics			•	•	
🥩 Meat					•
🐟 Fish				•	
🐠 Seafood				•	•

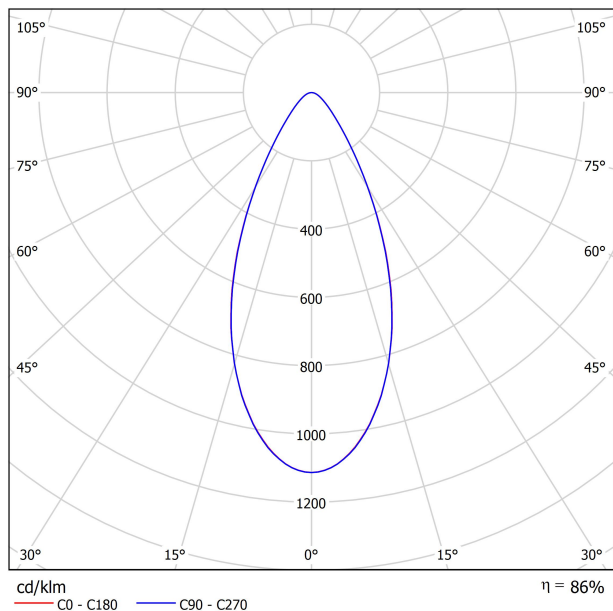
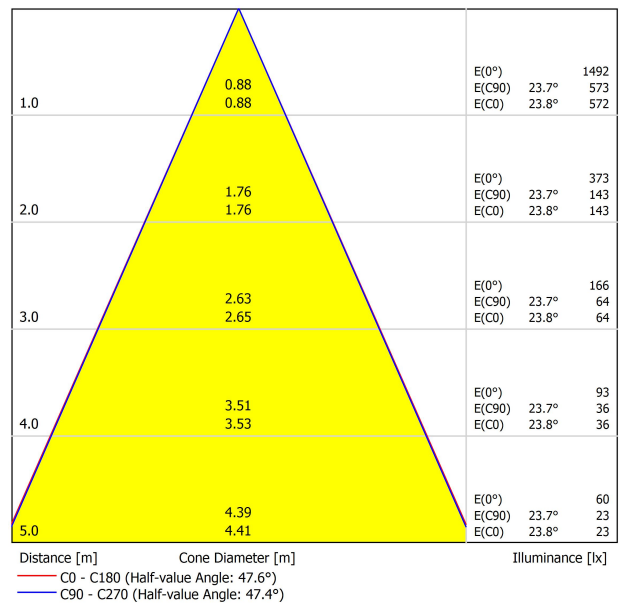

Arkoslight offre su alcuni dei suoi prodotti la possibilità di dotarli di un LED speciale per illuminazione orientata alla promozione visiva di beni e prodotti a scopo commerciale.

Si tratta di un LED ad alta cromaticità che mette in rilievo le tonalità che favoriscono la percezione psicologica positiva dell'oggetto illuminato.

Questa sorgente di luce LED speciale offre una gamma di colori più attraenti e intensi, superiore a quella che può offrire un LED convenzionale. Ciò si ottiene grazie alla configurazione del LED secondo un "parametro speciale di saturazione" che fa in modo che i colori e la texture degli oggetti appaiano più attraenti all'interno dello spettro di luce visibile. A tale scopo si seleziona, in ciascun caso, l'apposito diodo e il suo fosforo di rivestimento specifico.

MAGNETIC 24V CONNECTOR

ARKOSLIGHT®

MANDATORY FOR INSTALLATION

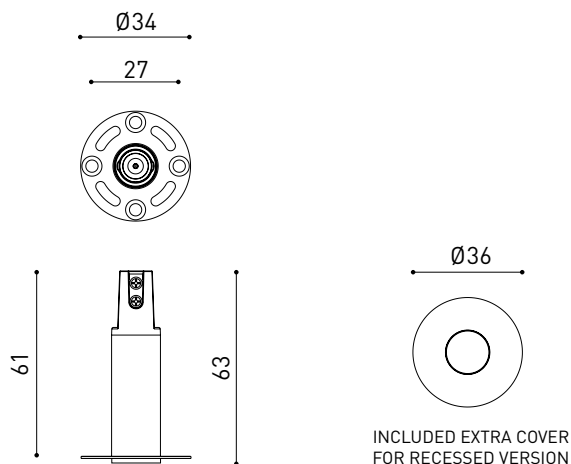

PRODUCT	
Model	Magnetic connector accessory
Reference	A435-01- 00 W <input type="checkbox"/> N <input checked="" type="checkbox"/>
Category	Accessories



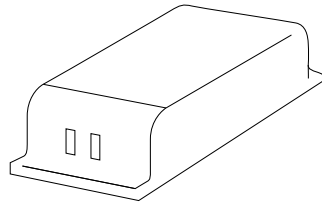

			P	V	D (A x B x C)
24V POWER SUPPLY	ON/OFF	0434-01-37	60W	24V	180 x 52 x 30mm
		0433-10-22	100W	24V	295 x 43 x 30mm

220 V~
240 V~

MUST BE PLACED ON REMOTE

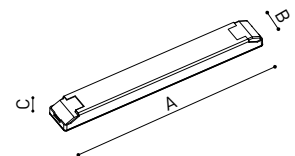

				V	D (A x B x C)
24V Dimmer		0433-01-32	DALI/PUSH	24V	181 x 42 x 20mm
		0433-01-35	CASAMBI	24V	72,6 x 30 x 18mm
		0434-01-64	WIFI	24V	105 x 44 x 23mm

24V

MUST BE PLACED ON REMOTE

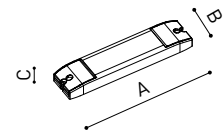

DROP VOLTAGE TABLE

POWER (W)	CABLE SECTION (mm ²)	CABLE LENGHT (m)
60	0,75	30
	1,5	30
100	0,75	20
	1,5	30

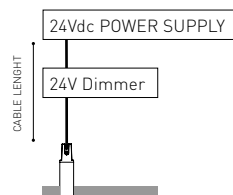



INSTALLATION GUIDE

https://youtu.be/sa_xAgj4ji4

PRODUCT

Model	Trimless Tool D16 X D34 MM
Reference	A478-00-00
Category	Accessories

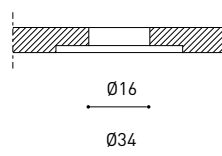
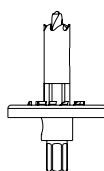



	PRODUCT
Model	Anti-glare Honeycomb Louver
Reference	A498-90-00 WT NT
Category	Accessories
	NOT SOLD SEPARATELY





	PRODUCT
Model	Anti-glare Screen
Reference	A498-90-01 WT NT
Category	Accessories
	NOT SOLD SEPARATELY





	PRODUCT
Model	Linear Filter
Reference	A498-90-02 WT NT
Category	Accessories
	NOT SOLD SEPARATELY SUITABLE FOR BEAM $\leq 34^\circ$



Fuente de luz (LED) reemplazable por un profesional autorizado
 Replaceable (LED only) light source by an authorized professional.
 Source lumineuse (LED) remplaçable par un professionnel agréé
 Sorgente luminosa (LED) sostituibile da parte di un professionista autorizzato
 Austauschbare (LED) Lichtquelle durch einen autorisierten Fachmann



Equipo de control reemplazable por un profesional autorizado
 Replaceable control gear by an authorized professional
 Dispositif de commande remplaçable par un professionnel agréé
 Alimentatore sostituibile da parte di un professionista autorizzato
 Auswechselbares Betriebsgerät durch autorisierten Fachmann

INSTRUCCIONES PARA EL FINAL DE VIDA Y LA ELIMINACIÓN LOS COMPONENTES
 INSTRUCTIONS ON END-OF-LIFE AND COMPONENT DISPOSAL
 INSTRUCTIONS POUR LA GESTION DES COMPOSANTS EN FIN DE VIE ET LEUR MISE AU REBUT
 ISTRUZIONI PER IL FINE VITA E LO SMALTIMENTO DEI COMPONENTI
 ANWEISUNGEN ZUR ENTSORGUNG DER LEUCHTENKOMPONENTEN



Interrumpir la alimentación del aparato
 Cut the power supply to the luminaire
 Couper l'alimentation du luminaire
 Interrompere l'alimentazione dell'apparecchio
 Stromversorgung der Leuchte unterbrechen



Quitar la(s) fuente(s) de luz para el desecho
 Remove light source(s) for disposal
 Retirer la (les) source(s) lumineuse(s) pour l'élimination
 Rimuovere la/le sorgente/e di luce per lo smaltimento
 Lichtquelle(n) zur Entsorgung entfernen

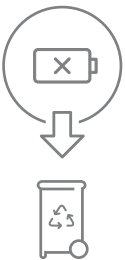

Quitar la batería para el desecho
 Remove the battery for decommissioning
 Retirer la batterie pour sa mise au rebut
 Rimuovere la batteria per la dismissione
 Die Batterie ordnungsgemäß entsorgen



Quitar el equipo de control para el desecho
 Remove control gear for disposal
 Retirer le dispositif de commande pour l'élimination
 Rimuovere l'alimentatore per lo smaltimento
 Betriebsgerät zur Entsorgung ausbauen

Enviar los materiales a un centro de recogida RAEE
 Send the materials to a WEEE collection centre
 Envoyer les matériaux dans une déchetterie DEEE
 Inviare i materiali ad un centro di raccolta RAEE
 Die Materialien in einem WEEE-Zentrum entsorgen

