

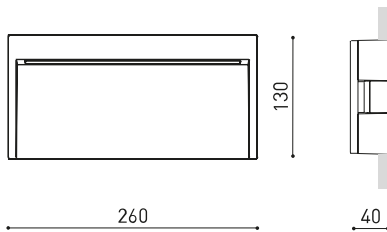

DIMENSIONS



ACCESSORIES



CONCRETE BOX ACCESSORY

Name	SLIM 2700K GT
Reference	A5150010GT
Color	Textured grey
RAL	7021
Category	OUTDOOR

Type	LED
Gross luminous flux	975 lm
Colour temperature	2700 K
Chromatic stability	MacAdam Step 2
Colour Rendering Index	CRI>90
Power	6,8 W
Current	500 mA
Efficacy	143 lm/W
LED lifespan	L80B10 >60.000h

Lighting efficiency	24%
Light beam angle	75°

Driver	Included
Power values of the system	8,74 W
Frequency	50/60 Hz
Dimming	No Dim
Electrical insulation class	□

Sealing	IP65
Recess measurements	254 x 122 mm
Outdoor Use	Yes
Weight	1,08 g
Packaged weight	1,175 g
Packaging dimensions	307 x 160 x 50 mm
Units per package	1
Materials	Aluminium / Polycarbonate



With the aim of offering new creative tools to the lighting designer, the Slim collection arrives outdoors as an exceptional floor washer. The work on the optics and its markedly thin and elongated body project a constant and homogeneous vertical light. In the middle of the night, Slim allows us to dream of daytime atmospheres where light finds no limits or conditions. A comfortable illumination that marks our transit and avoids the classic shadows between luminaires and the edges of the path, uniformly bathing the ground from its confluence with the perpendicular. It should be installed at a maximum distance of 50 cm from the ground and 140 cm between spotlights.

POLAR DIAGRAM

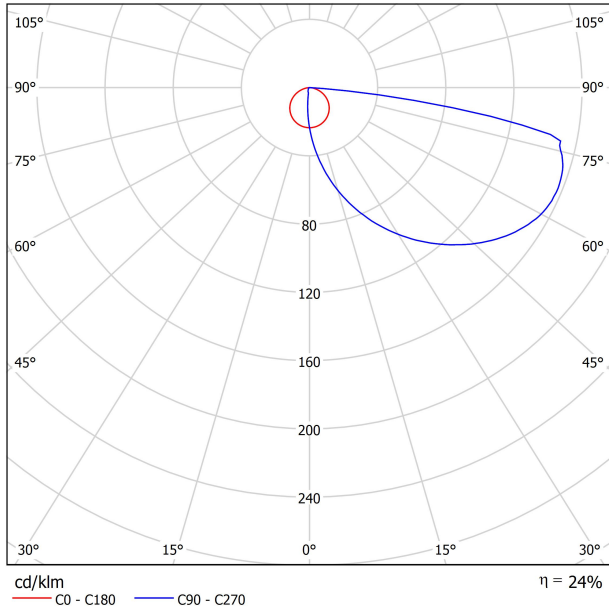

CONICAL DIAGRAM

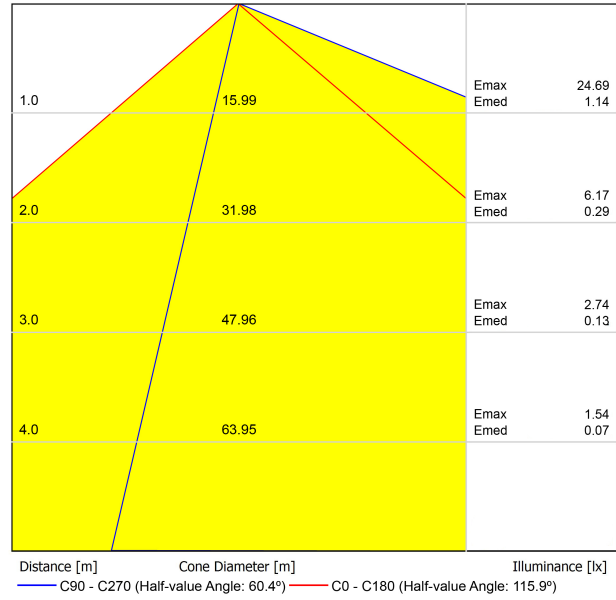

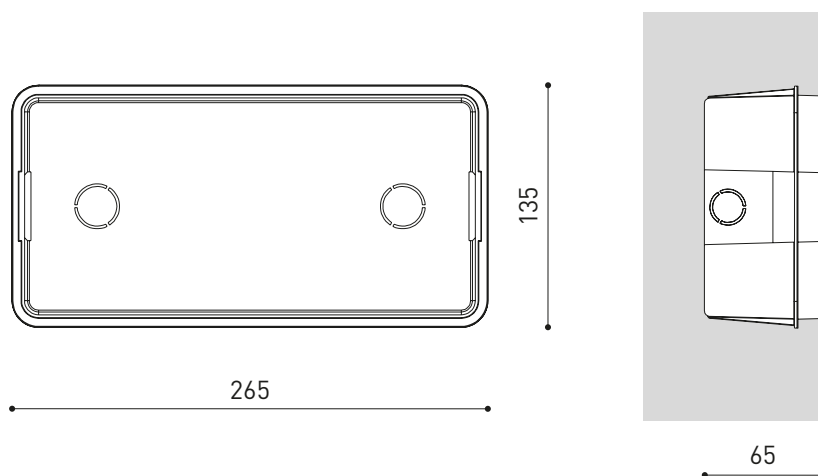

	PRODUCT
Model	Slim Concrete Box Accessory
Reference	A515-90-00
Category	Accessories



270 X 140

Slim's auxiliary box allows it to be installed inside concrete walls. (It is not needed when installed in cardboard or plaster walls).

This accessory can be purchased independently, for the subsequent placement of Rhino once the works have been finished.



Fuente de luz (LED) reemplazable por un profesional autorizado

Replaceable (LED only) light source by an authorized professional.

Source lumineuse (LED) remplaçable par un professionnel agréé

Sorgente luminosa (LED) sostituibile da parte di un professionista autorizzato

Austauschbare (LED) Lichtquelle durch einen autorisierten Fachmann



Equipo de control reemplazable por un profesional autorizado

Replaceable control gear by an authorized professional

Dispositif de commande remplaçable par un professionnel agréé

Alimentatore sostituibile da parte di un professionista autorizzato

Auswechselbares Betriebsgerät durch autorisierten Fachmann

INSTRUCCIONES PARA EL FINAL DE VIDA Y LA ELIMINACIÓN LOS COMPONENTES
 INSTRUCTIONS ON END-OF-LIFE AND COMPONENT DISPOSAL
 INSTRUCTIONS POUR LA GESTION DES COMPOSANTS EN FIN DE VIE ET LEUR MISE AU REBUT
 ISTRUZIONI PER IL FINE VITA E LO SMALTIMENTO DEI COMPONENTI
 ANWEISUNGEN ZUR ENTSORGUNG DER LEUCHTENKOMPONENTEN



Interrumpir la alimentación del aparato
 Cut the power supply to the luminaire
 Couper l'alimentation du luminaire
 Interrompere l'alimentazione dell'apparecchio
 Stromversorgung der Leuchte unterbrechen



Quitar la(s) fuente(s) de luz para el desecho
 Remove light source(s) for disposal
 Retirer la (les) source(s) lumineuse(s) pour l'élimination
 Rimuovere la/le sorgente/e di luce per lo smaltimento
 Lichtquelle(n) zur Entsorgung entfernen



Quitar la batería para el desecho
 Remove the battery for decommissioning
 Retirer la batterie pour sa mise au rebut
 Rimuovere la batteria per la dismissione
 Die Batterie ordnungsgemäß entsorgen



Quitar el equipo de control para el desecho
 Remove control gear for disposal
 Retirer le dispositif de commande pour l'élimination
 Rimuovere l'alimentatore per lo smaltimento
 Betriebsgerät zur Entsorgung ausbauen



Enviar los materiales a un centro de recogida RAEE
 Send the materials to a WEEE collection centre
 Envoyer les matériaux dans une déchetterie DEEE
 Inviare i materiali ad un centro di raccolta RAEE
 Die Materialien in einem WEEE-Zentrum entsorgen

