

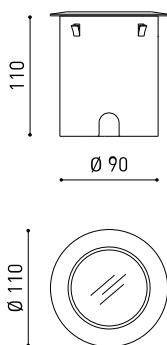

Dimensiones



Accesorios



DRIVER OPTIONS



CONNECTOR IP67

PRODUCTO

Nombre	DARK M 48V 3 2700K NX
Referencia	A5220310NX
Color	Acero Inoxidable
Categoría	OUTDOOR

FUENTE DE LUZ

Tipo	LED
Flujo luminoso	1220 lm
Temperatura de color	2700 K
Estabilidad cromática	MacAdam Step 2
Índice de reproducción cromática	CRI > 90
Potencia	10,5 W
Eficacia	116 lm/W
Horas de vida del LED	L90B10 > 55.000h
Eficiencia energética	E

LUMINARIA | DATOS FOTOMÉTRICOS

Eficiencia lumínica	75%
Ángulo del haz de luz	38°

LUMINARIA | DATOS ELÉCTRICOS

Potencia del sistema	11,58 W
Tensión	48Vdc
Regulación	DALI - Push / WIFI
Clase de seguridad eléctrica	II

OTROS DATOS

Estanqueidad	IP67
Resistencia a impactos	IK08
Medidas de empotramiento	Ø92 mm
Uso en exteriores	Sí
Temperatura máxima en superficie	80°
Carga soportada	7000
Peso	950 g
Peso con embalaje	1055 g
Dimensiones embalaje	155 x 137 x 124 mm
Unidades por embalaje	1
Materiales	Acero Inoxidable (AISI 304) / Aluminio / Cristal Transparente



Dark es una luminaria LED empotrable de suelo para ser aplicada junto a elementos que se desean iluminar ascendentemente para destacar su presencia arquitectónica (estructuras, muros, árboles, jardines, cornisas, etc.).
 *** NOTA: Caja de empotramiento incluida.

Diagrama polar

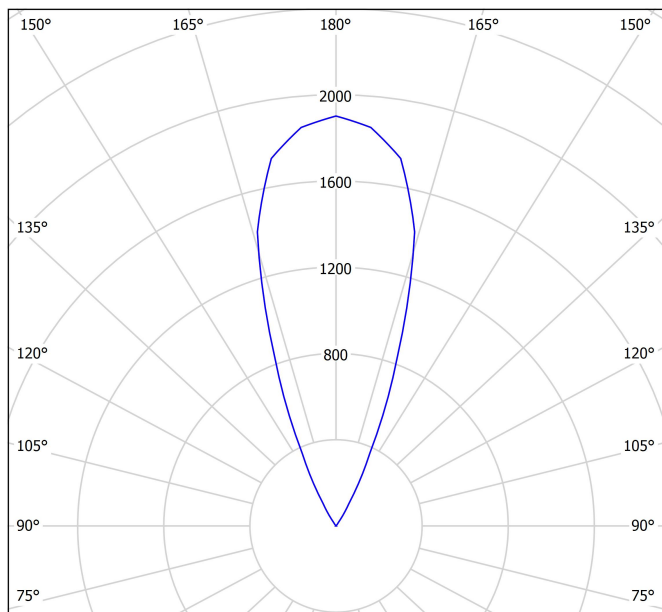

cd/klm
 — C0 - C180 — C90 - C270

η = 75%

Diagrama cónico

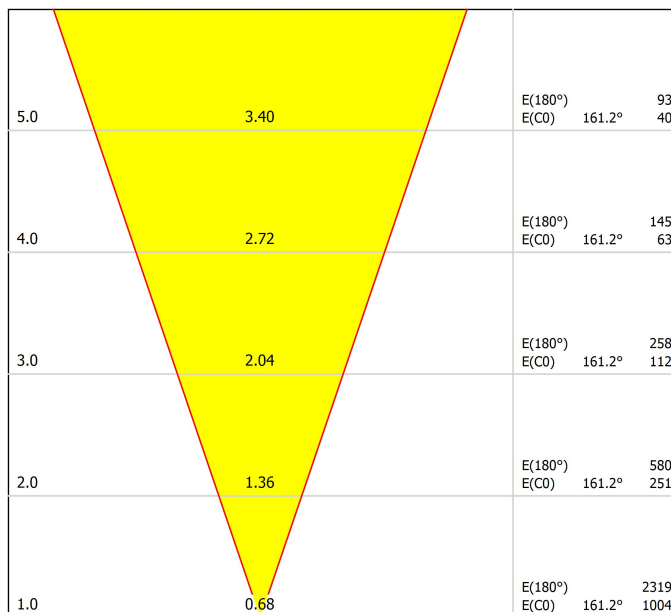

Distance [m] Cone Diameter [m] Illuminance [lx]
 — C0 - C180 (Half-value Angle: 37.6°)

5.0	3.40	E(180°) E(C0)	161.2°	93 40
4.0	2.72	E(180°) E(C0)	161.2°	145 63
3.0	2.04	E(180°) E(C0)	161.2°	258 112
2.0	1.36	E(180°) E(C0)	161.2°	580 251
1.0	0.68	E(180°) E(C0)	161.2°	2319 1004

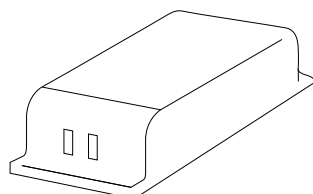

		P	D (A x B x C)
48V Power Supply	0434-01-62	150W	350 x 30 x 18mm
220 V~ 240 V~	IP20	Driver must be placed on remote	

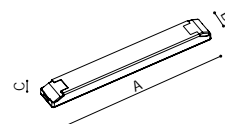

Remote Constant Voltage Dimmer	0433-01-32	DALI / Push	181 x 42 x 20mm
	0434-01-64	WIFI	105 x 44 x 23mm
48V	IP20	Dimmer must be placed on remote	

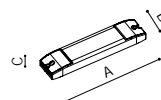

DROPVOLTAGE TABLE

POWER (W)	CABLE SECTION (mm ²)	CABLE LENGTH (m)		
		<25	<50	<75
150	0,75	√	X	X
	1,0	√	√	X
	1,5	√	√	√

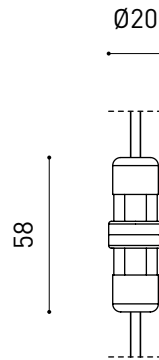

PRODUCT	
Model	Connector IP67
Reference	0434-01-66- N
Category	Accessories

For cable Ø4,5-6,5mm, section ≤1,5mm²

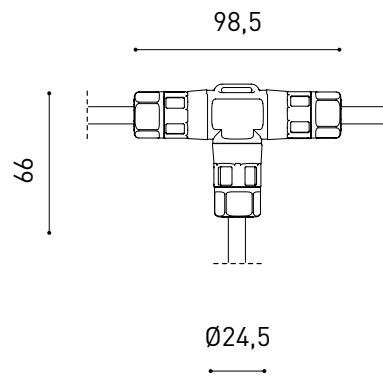

PRODUCT	
Model	Connector IP67 T-Shape
Reference	0434-01-75- N
Category	Accessories

For cable Ø3,5-5,5mm, section ≤1,5mm²



Fuente de luz (LED) reemplazable por un profesional autorizado

Replaceable (LED only) light source by an authorized professional.

Source lumineuse (LED) remplaçable par un professionnel agréé

Sorgente luminosa (LED) sostituibile da parte di un professionista autorizzato

Austauschbare (LED) Lichtquelle durch einen autorisierten Fachmann



Equipo de control reemplazable por un profesional autorizado

Replaceable control gear by an authorized professional

Dispositif de commande remplaçable par un professionnel agréé

Alimentatore sostituibile da parte di un professionista autorizzato

Auswechselbares Betriebsgerät durch autorisierten Fachmann

Instrucciones para el final de vida y la eliminación de los componentes:

Instructions on end-of-life and component disposal:

Instructions pour la gestion des composants en fin de vie et leur mise au rebut :

Istruzioni per il fine vita e lo smaltimento dei componenti:

Anweisungen zur entsorgung der Leuchtenkomponenten:



Interrumpir la alimentación del aparato
Cut the power supply to the luminaire
Couper l'alimentation du luminaire
Interrompere l'alimentazione dell'apparecchio
Stromversorgung der Leuchte unterbrechen



Quitar la(s) fuente(s) de luz para el desecho
Remove light source(s) for disposal
Retirer la (les) source(s) lumineuse(s) pour l'élimination
Rimuovere la/le sorgente/e di luce per lo smaltimento
Lichtquelle(n) zur Entsorgung entfernen



Quitar la batería para el desecho
Remove the battery for decommissioning
Retirer la batterie pour sa mise au rebut
Rimuovere la batteria per la dismissione
Die Batterie ordnungsgemäß entsorgen



Quitar el equipo de control para el desecho
Remove control gear for disposal
Retirer le dispositif de commande pour l'élimination
Rimuovere l'alimentatore per lo smaltimento
Betriebsgerät zur Entsorgung ausbauen



Enviar los materiales a un centro de recogida RAEE
Send the materials to a WEEE collection centre
Envoyer les matériaux dans une déchetterie DEEE
Inviare i materiali ad un centro di raccolta RAEE
Die Materialien in einem WEEE-Zentrum entsorgen

