

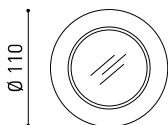

Dimensiones

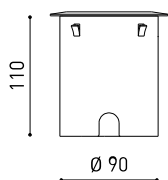

Accesorios



DRIVER OPTIONS



CONNECTOR IP67

PRODUCTO

| | |
|------------|---------------------------------|
| Nombre | DARK M 48V HONEYCOMB 2 2700K NX |
| Referencia | A5230210NX |
| Color | Acero Inoxidable |
| Categoría | OUTDOOR |

FUENTE DE LUZ

| | |
|----------------------------------|------------------|
| Tipo | LED |
| Flujo luminoso | 865 lm |
| Temperatura de color | 2700 K |
| Estabilidad cromática | MacAdam Step 2 |
| Índice de reproducción cromática | CRI > 90 |
| Potencia | 6,7 W |
| Eficacia | 129 lm/W |
| Horas de vida del LED | L90B10 > 55.000h |
| Eficiencia energética | E |

LUMINARIA | DATOS FOTOMÉTRICOS

| | |
|-----------------------|-----|
| Eficiencia lumínica | 53% |
| Ángulo del haz de luz | 34° |

LUMINARIA | DATOS ELÉCTRICOS

| | |
|------------------------------|--------------------|
| Potencia del sistema | 7,59 W |
| Tensión | 48Vdc |
| Regulación | DALI - Push / WIFI |
| Clase de seguridad eléctrica | II |

OTROS DATOS

| | |
|----------------------------------|---|
| Estanqueidad | IP67 |
| Resistencia a impactos | IK08 |
| Medidas de empotramiento | Ø92 mm |
| Uso en exteriores | Sí |
| Temperatura máxima en superficie | 68° |
| Carga soportada | 7000 |
| Peso | 925 g |
| Peso con embalaje | 1030 g |
| Dimensiones embalaje | 155 x 137 x 124 mm |
| Unidades por embalaje | 1 |
| Materiales | Acero Inoxidable (AISI 304) / Aluminio / Cristal Transparente |



Dark es una luminaria LED empotrable de suelo para ser aplicada junto a elementos que se desean iluminar ascendentemente para destacar su presencia arquitectónica (estructuras, muros, árboles, jardines, cornisas, etc.).
 *** NOTA: Caja de empotramiento incluida.

Diagrama polar

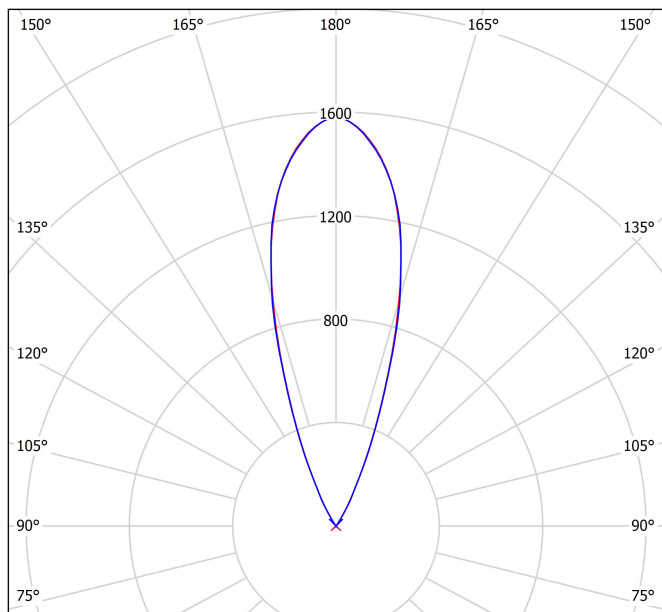

cd/klm
 — C0 - C180 — C90 - C270

$\eta = 53\%$

Diagrama cónico

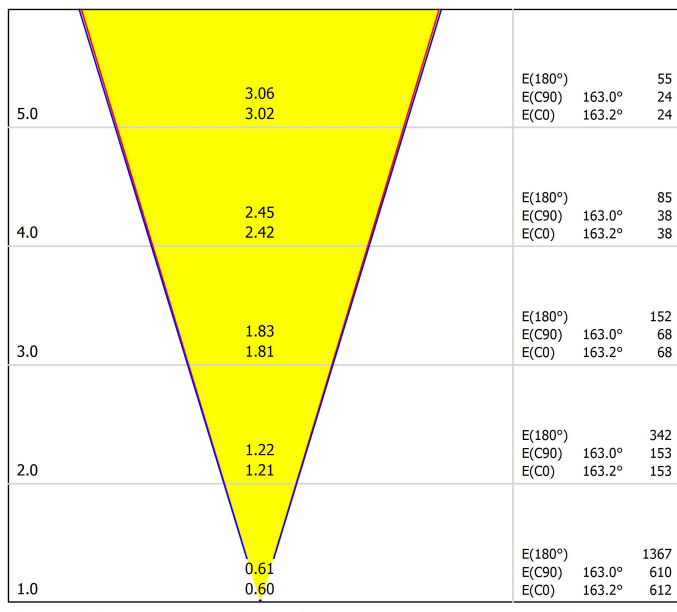

Distance [m] Cone Diameter [m] Illuminance [lx]
 — C0 - C180 (Half-value Angle: 33.6°)
 — C90 - C270 (Half-value Angle: 34.0°)



| | | P | D (A x B x C) |
|------------------|------------|---------------------------------|-----------------|
| 48V Power Supply | 0434-01-62 | 150W | 350 x 30 x 18mm |
| 220 V~ 240 V~ | IP20 | Driver must be placed on remote | |

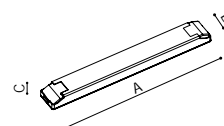

| | | | D (A x B x C) |
|--------------------------------|------------|---------------------------------|-----------------|
| Remote Constant Voltage Dimmer | 0433-01-32 | DALI / Push | 181 x 42 x 20mm |
| | 0434-01-64 | WIFI | 105 x 44 x 23mm |
| 48V | IP20 | Dimmer must be placed on remote | |

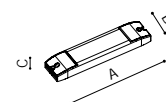

DROPVOLTAGE TABLE

| POWER (W) | CABLE SECTION (mm ²) | CABLE LENGTH (m) | | |
|-----------|----------------------------------|------------------|-----|-----|
| | | <25 | <50 | <75 |
| 150 | 0,75 | √ | X | X |
| | 1,0 | √ | √ | X |
| | 1,5 | √ | √ | √ |

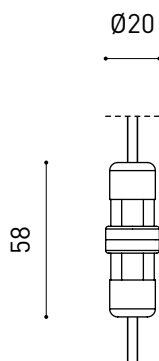

| PRODUCT | |
|-----------|-----------------|
| Model | Connector IP67 |
| Reference | 0434-01-66- N |
| Category | Accessories |

For cable Ø4,5-6,5mm, section ≤1,5mm²

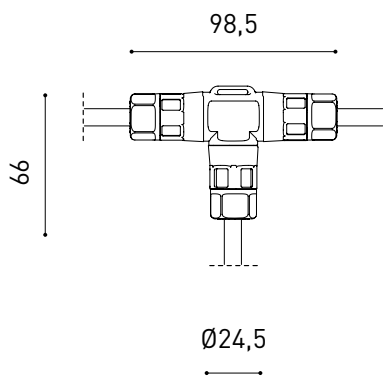

| PRODUCT | |
|-----------|------------------------|
| Model | Connector IP67 T-Shape |
| Reference | 0434-01-75- N |
| Category | Accessories |

For cable Ø3,5-5,5mm, section ≤1,5mm²



Fuente de luz (LED) reemplazable por un profesional autorizado

Replaceable (LED only) light source by an authorized professional.

Source lumineuse (LED) remplaçable par un professionnel agréé

Sorgente luminosa (LED) sostituibile da parte di un professionista autorizzato

Austauschbare (LED) Lichtquelle durch einen autorisierten Fachmann



Equipo de control reemplazable por un profesional autorizado

Replaceable control gear by an authorized professional

Dispositif de commande remplaçable par un professionnel agréé

Alimentatore sostituibile da parte di un professionista autorizzato

Auswechselbares Betriebsgerät durch autorisierten Fachmann

Instrucciones para el final de vida y la eliminación de los componentes:

Instructions on end-of-life and component disposal:

Instructions pour la gestion des composants en fin de vie et leur mise au rebut :

Istruzioni per il fine vita e lo smaltimento dei componenti:

Anweisungen zur entsorgung der Leuchtenkomponenten:



Interrumpir la alimentación del aparato
Cut the power supply to the luminaire
Couper l'alimentation du luminaire
Interrompere l'alimentazione dell'apparecchio
Stromversorgung der Leuchte unterbrechen



Quitar la(s) fuente(s) de luz para el desecho
Remove light source(s) for disposal
Retirer la (les) source(s) lumineuse(s) pour l'élimination
Rimuovere la/le sorgente/e di luce per lo smaltimento
Lichtquelle(n) zur Entsorgung entfernen



Quitar la batería para el desecho
Remove the battery for decommissioning
Retirer la batterie pour sa mise au rebut
Rimuovere la batteria per la dismissione
Die Batterie ordnungsgemäß entsorgen



Quitar el equipo de control para el desecho
Remove control gear for disposal
Retirer le dispositif de commande pour l'élimination
Rimuovere l'alimentatore per lo smaltimento
Betriebsgerät zur Entsorgung ausbauen



Enviar los materiales a un centro de recogida RAEE
Send the materials to a WEEE collection centre
Envoyer les matériaux dans une déchetterie DEEE
Inviare i materiali ad un centro di raccolta RAEE
Die Materialien in einem WEEE-Zentrum entsorgen

